

2ª  
ED.



2022 TU HERRAMIENTA **PT**

# INDICE DE PRODUTOS



## CAIXAS DE FERRAMENTAS

7

CAIXAS DE FERRAMENTAS



CAIXAS DE FERRAMENTAS DE ALUMÍNIO



1" E 3/4"



SETS DE PONTAS / CHAVES



CAIXA DE PARAFUSOS

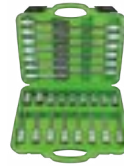

SETS DE BITS DE CHAVE DE FENDA



ADAPTADORES



EM POLEGADA



CAIXAS DE FERRAMENTAS COM ROQUETE



CONJUNTO DE CHAVES / PONTAS



ALTO VOLTAGEM



## FERRAMENTAS MANUAIS

35

CHAVES



FER. EM POLEGADA



CHAVES DE FENDA



FER. DE MEDIÇÃO



CADEDADOS



MARTELO



SERRAS



PUNÇÕES



REBITADORAS



ROQUETES



BARRAS DE EXTENSÃO



CORTA TUBOS



PELACALBLES



ALICATES



CHAVE DE CANOS



GARAMPOS DE FIXAÇÃO



CORTADORES PARAFUSO



## MOBILIÁRIO DE OFICINA

67

CARROS DE FERRAMENTAS



MÓDULOS



PEÇAS DE REPOSIÇÃO PARA CARROS



ARMÁRIOS



ACESSÓRIOS



MESAS DE TRABALHO



CAJAS DE HERRAMIENTAS



TABURETES



CAMAS

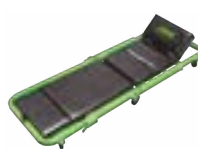

BOLSAS / MOCHILAS



BIGORNAS / TORNOS



## FERRAMENTA A BATERIAS COM MOTOR BRUSHLESS

85

CHAVES



APARAFUSADOR



BROCA



MARTELO GIRATÓRIO



POLIDOR



MOEDOR DE ÂNGULO



SIERRAS



FAROL DE TRABALHO



DIVERSOS



JARDINAGEM



BATERIAS / CARREGADORES



ACESSÓRIOS/ MOCHILAS







## ILUMINAÇÃO

111

LANTERNA DE BOLSO



GAMBIARRA DE LUZ FRONTAL DE CABEÇA



LUPA LED



LUZ DE TRABALHO



ALINHADOR DE FARÓIS



BALIZA DE EMERGÊNCIA



PIRALIMPO



AVISADORES ACÚSTICOS



FAROL AUXILIAR



BARRAS PARA REBOQUE



LÂMPADAS PARA TURISMOS



## FERRAMENTAS PNEUMÁTICAS

129

PISTOLAS DE IMPACTO



ROQUETES



REBARBADORA



AMOLADORA



MÁQUINA DE FURAR



LIXADEIRA ORBITAL



KITS PULIDORAS



PISTOLAS DE AR



CARRETEL DE MANGUEIRA DE AR



CONECTORES



## FERRAMENTAS DE IMPACTO

149

CHAVES DE IMPACTO



PONTAS DE IMPACTO



ADAPTADORES



AUMENTOS DE IMPACTO



CHAVES EM DESMANCHA



VASOS PARA VEÍCULOS PESADOS



## CARROÇARIA

159

KITS DE REPARO



PARA FARÓIS



PALANCAS



ALICATES



PISTOLA SILICONE



SERINGA NEUMÁTICA



CINTA DE FIXAÇÃO



CARRO PARA ARMAZENAGEM



CAVALETE



CUIDADO DO VEÍCULO



## TRAVÕES

175

RECOLHA DE EMBOLOS

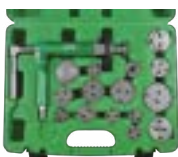

REPARAÇÃO/MANUTENÇÃO



ALICATE PARA TRAVÕES



TESTE DE FLUÍDO DE TRAVÕES



SANGRADOR DE TRAVÕES





## UTILLAJE

179

FILTROS



ÓLEO



INJEÇÃO



AQUECEDORES



EXTRACTORES

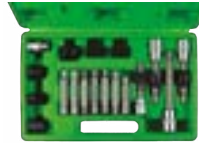

ESCAPE



DINAMOMÉTRICAS



MEDIÇÃO



HERRAMIENTAS ESPECIALES



FERRAMENTAS ESPECIAIS



AR CONDICIONADO



## KITS DE BLOQUEIO

217

BMW, MERCEDES, VAG, RENAULT, NISSAN, FORD, MAZDA, JAGUAR, LAND ROVER, OPEL, VAUXHALL, CITROËN, PEUGEOT...



GABINETE COM FERRAMENTAS DE AJUSTE DE SINCRONIZAÇÃO



## ACESSÓRIOS LUBRIFICANTES

241

TANQUE DE ARMAZENAMENTO DE TAMBOR



PARA UREA AUS32



BOMBAS DISPENSADORAS



BOMBA MANUAL PARA SISTEMAS DE TRANSMISSÕES



DRENAGEM DO ÓLEO



SERINGA DE SUÇÃO



PISTOLA DE LUBRIFICAÇÃO



VÁRIOS



## FERRAMENTAS HIDRÁULICAS

253

MACACO HIDRÁULICO



SOLLEVATORE A BOTTIGLIA



GATOS OLEONEUMÁTICOS



PORTA RODAS



PRESAS



GRUAS



SUORTES PARA MOTORES



MESAS HIDRÁULICAS



PORTA PALETES MANUAL



## FERRAMENTAS ELÉCTRICAS

265

CABOS DE ARRANQUE



ARRANCADOR DE VEÍCULOS



CARREGADORES DE BATERIA



COMPROBADORES BATERIA



TANQUE DE LIMPEZA DE PEÇAS



ASPIRADORES



PULVERIZADORES



LAVADORAS



ESMIRILADORA DUPLA



CARRETEL ELÉCTRICO



VENTILADORES

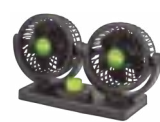





## ENERGIA RENOVÁVEIS E MOBILIDADE DE AMANHÃ

279

ESTAÇÃO DE ENERGIA



PAINEL SOLAR



CARRO ELÉTRICO



DISTÂNCIA DE SEGURANÇA

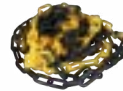

FERRAMENTAS ALTA VOLTAJEM



## ACESSÓRIOS

283

ACESSÓRIOS DE OFICINA



KITS EMERGÊNCIA



SENSORES DE ESTACIONAMENTO



AUTOMAÇÃO



ESCOVAS DE LIMPA VIDROS



CONTRAPESOS



PARA PNEUS



TUBOS FLEXÍVEL



## SEGURANÇA E EPI

305

EPI



CÂMARAS TÉRMICAS E TERMÔMETROS



LIMPEZA DE SUPERFÍCIES



LIMPADORES E FÓRMULAS HIDROALCOÓLICAS



DISPENSADORES



DISTÂNCIA DE SEGURANÇA



DESINFECÇÃO DE ESPAÇOS



MEDIDOR DE OZÔNIO



## CONSUMÍVEIS

315

PASACABLES



PINS



CHAVETAS



PARAFUSOS E NUTS



RIVETS



LAVAGENS



O-RINGS

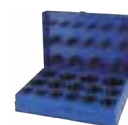

TUBOS TERMORETRÁDICOS



GREASERS



FUSE



TERMINAIS



CLIPS PLÁSTICOS



## ROUPA

337

339

## PROMOTIONALS

JBM

JAQUETA



COLETE



DISPOSITIVOS ELETRÔNICOS



ESPORTE EN CASA



PARA CASA



EXPOSITORES E ACESSÓRIOS



EMBALAGEM

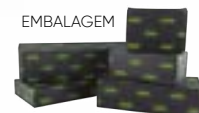



## Jbm e uma marca de ferramentas profissionais.

Somos uma empresa Lider dirigida para Industria e Auto.

Com 30 anos de experiência a JBM oferece um extenso catálogo com mais de 5000, artigos como ferramentas manuais, eléctricas a bateria, pneumáticas, Hidraulica, carros, equipamentos oficinais, iluminação, e toda a classe de Acessórios.

Fornecendo sempre no mercado as últimas novidades e melhores produtos para satisfazer as necessidades do consumidor.

Com uma distribuição rápida e eficaz em todo o mundo graças a uma rede consolidada com sede principal em Espanha com 6000m2 e mais de 15000 europalletes em Stock, vários armazéns complementares e sede em Jinhua com 1000m2 totalmente ligada a diferentes fornecedores.

Jbm pode fazer chegar a qualquer ponto do mundo todas as ferramentas que necessite.



+55

**EXPORTAMOS  
A MAIS DE 55  
PAÍSES**

+15.000

**EUROPALLETES  
EM STOCK**

+5.000

**PRODUTOS  
DISPONÍVEIS**

+450

**NOVOS  
PRODUTO  
2022**



## RESPONSABILIDADE SOCIAL CORPORATIVA

Em jbm estamos comprometidos com meio ambiente produzindo quase a totalidade da energia que consumimos devido a instalação de placas solares em nossos armazéns.

Estamos implementando planos de redução de emissões em todas as etapas de fabrico dos produtos e seu transporte, assim como aplicando programas de reciclagem inteligente até final de vida dos produtos.

Está catálogo está impresso devido há colaboração da única empresa certificada com ECOLABEL da península ibérica

Fazendo um mundo mais limpo para futuro





CAIXAS DE FERRAMENTA



9

CAIXAS DE FERRAMENTAS DE ALUMÍNIO



21

1" E 3/4"



24

SETS DE PONTAS / CHAVES



25

CAIXA DE PARAFUSOS



27

SETS DE BITS DE CHAVE DE FENDA



29

ADAPTADORES



29

FERRAMENTAS EM POLEGADA



30

CAIXAS DE FERRAMENTAS COM ROQUETE



31

CONJUNTO DE CHAVES / PONTAS



31

FERRAMENTAS ALTA VOLTAGEM



33



# CAIXAS DE FERRAMENTAS



**SERIE329**

# NOVO CORPO!

SUPERFÍCIES DE QUALIDADE



VEDAÇÕES DE METAL MELHORADOS

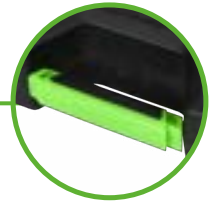

ALÇA DE BORRACHA PARA CONVENIÊNCIA DE TRANSPORTE



TELA COM SELO IMPRESSO DO LOGOTIPO JBM



DIVISÍVEL EM DOIS PARA UMA MELHOR ORGANIZAÇÃO



# CAIXA DE FERRAMENTAS DE 216 PEÇAS COM CHAVES HEXAGONAIS

**54034**

10,75

2

48

178,00€



CINCADO

**54045**

11,01

2

48

179,00€



CROMADO

CrV

216  
PCS

54045



DESMANCHA  
DISPONÍVEL

54034



DESMANCHA  
DISPONÍVEL

ACO  
S2



## CONTÉM

	<b>1/2"</b>	x14	13, 14, 15, 16, 17, 18, 19, 20, 21, 22, 24, 27, 30, 32mm
	<b>3/8"</b>	x10	10, 11, 12, 13, 14, 15, 16, 17, 18, 19mm
	<b>1/4"</b>	x13	4, 4.5, 5, 5.5, 6, 7, 8, 9, 10, 11, 12, 13, 14mm
	<b>1/2"</b>	x5	16, 17, 18, 19, 22mm
	<b>3/8"</b>	x6	10, 11, 12, 13, 14, 15mm
	<b>1/4"</b>	x7	4, 5, 6, 7, 8, 9, 10mm
	<b>1/2"</b>	x3	E20, E22, E24
	<b>3/8"</b>	x6	E10, E11, E12, E14, E16, E18
	<b>1/4"</b>	x5	E4, E5, E6, E7, E8
		x3	1/2" - 3/8" - 1/4"
	<b>1/2"</b>	x2	125, 250mm
	<b>3/8"</b>	x1	125mm
	<b>1/4"</b>	x2	50, 100mm
		x3	1/2" - 3/8" - 1/4"
	<b>1/2"</b>	x1	adaptador 3/8" H x 1/2" M

	<b>1/2"</b>	x1	8mm
	<b>3/8"</b>	x1	8mm
	<b>1/4"</b>	x1	6mm
	<b>1/2"</b>	x2	16, 21mm
	<b>3/8"</b>	x1	18mm
	<b>1/2"</b>	x12	8, 9, 10, 11, 12, 13, 14, 15, 16, 17, 18, 19mm
	<b>1/2"</b>	x7	1,27, 1,5, 2, 2,5, 3, 4, 5mm
	<b>1/4"</b>	x1	
	<b>1/4"</b>	x1	
	<b>1/4"</b>	x1	
	<b>1/2"</b>	x1	T70
	<b>1/2"</b>	x1	14mm
		x3	PH0, PH1, PH2
		x3	PZ0, PZ1, PZ2
		x4	3, 4, 5, 6mm
		x4	SL4, SL5.5, SL6.5, SL7
		x8	T8, T9, T10, T15, T20, T25, T27, T30
		x8	T8, T9, T10, T15, T20, T25, T27, T30

	<b>8mm</b>	x4	7, 8, 10, 12mm
	<b>6mm</b>	x6	2, 2.5, 3, 4, 5, 6mm
	<b>8mm</b>	x3	SL8, SL10, SL12
	<b>8mm</b>	x3	PH2, PH3, PH4
	<b>8mm</b>	x3	PZ2, PZ3, PZ4
	<b>8mm</b>	x5	T40, T45, T50, T55, T60
	<b>6mm</b>	x3	T5, T6, T7
	<b>8mm</b>	x5	T40, T45, T50, T55, T60
	<b>6mm</b>	x1	T7
	<b>8mm</b>	x4	M10, M11, M12, M13
	<b>6mm</b>	x5	M5, M6, M7, M8, M9
	<b>8mm</b>	x2	M10, M12
	<b>6mm</b>	x3	M5, M6, M8
	<b>8mm</b>	x1	TS50
	<b>6mm</b>	x8	TS10, TS15, TS20, TS25, TS27, TS30, TS40, TS45
		x4	0, 1, 2, 3mm
		x3	6, 8, 10mm
	<b>6mm</b>	x4	4, 6, 8, 10mm
		x3	1, 2, 3mm
		x4	1, 2, 3, 4mm
	<b>6mm</b>	x1	1/4"

# CAIXA DE FERRAMENTAS DE 179 PEÇAS COM CHAVES HEXAGONAIS

**54035**

8,95

2

48

149,00€



CINCADO

**54046**

8,95

2

48

150,00€



CROMADO

CrV

179  
PCS

**54035**



DESMANCHA  
DISPONÍVEL

**54046**



DESMANCHA  
DISPONÍVEL



AÇO  
S2

## CONTÉM

	1/2" x17	10, 11, 12, 13, 14, 15, 16, 17, 18, 19, 20, 21, 22, 24, 27, 30, 32mm
	3/8" x10	10, 11, 12, 13, 14, 15, 16, 17, 18, 19mm
	1/4" x13	4, 4.5, 5, 5.5, 6, 7, 8, 9, 10, 11, 12, 13, 14mm
	1/2" x5	16, 17, 18, 19, 22mm
	3/8" x6	10, 11, 12, 13, 14, 15mm
	1/4" x7	4, 5, 6, 7, 8, 9, 10mm
	1/2" x2	E20, E24
	3/8" x6	E10, E11, E12, E14, E16, E18
	1/4" x5	E4, E5, E6, E7, E8
	T2	x3 1/2" - 3/8" - 1/4"
	1/2" x1	125mm
	3/8" x1	125mm
	1/4" x2	50, 100mm
	1/2" x1	250mm

	x3	1/2" - 3/8" - 1/4"
	1/2" x2	16, 21mm
	3/8" x1	18mm
	1/2" x1	8mm
	3/8" x1	8mm
	1/4" x1	6mm
	x7	1,27, 1,5, 2, 2,5, 3, 4, 5mm
	x1	1/4"
	x1	1/4"
	x3	PH1, PH2, PH3
	x3	PZ1, PZ2, PZ3
	1/4" x5	2, 3, 4, 5, 6mm
	1/4" x3	SL4, SL5.5, SL7
	x8	T8, T9, T10, T15, T20, T25, T27, T30
	x8	T8, T9, T10, T15, T20, T25, T27, T30

	x11	T5, T6, T7, T8, T9, T10, T15, T20, T25, T27, T30
	x9	T7, T10, T15, T20, T25, T27, T30, T40, T45
	x5	M5, M6, M7, M8, M9
	x3	M5, M6, M8
	x2	PH3, PH4
	x2	PZ3, PZ4
	x8	7, 8, 10, 12, 14mm
	x3	SL8, SL10, SL12
	x6	T40, T45, T50, T55, T60, T70
	x6	T40, T45, T50, T55, T60, T70



# CAIXA DE FERRAMENTAS DE 113 PEÇAS

12 FACES XZN

**54036**

6,55 3 108

99,00€



CINCADO

**54047**

7,06 3 108

100,00€



CROMADO

CrV

113  
PCS

54047



DESMANCHA  
DISPONÍVEL

54036



DESMANCHA  
DISPONÍVEL



ACO  
S2



## CONTÉM

	<b>1/2"</b>	x17	10, 11, 12, 13, 14, 15, 16, 17, 18, 19, 20, 21, 22, 24, 27, 30, 32mm
	<b>1/4"</b>	x13	4, 4.5, 5, 5.5, 6, 7, 8, 9, 10, 11, 12, 13, 14mm
	<b>1/2"</b>	x5	14, 15, 17, 19, 22mm
	<b>1/4"</b>	x8	6, 7, 8, 9, 10, 11, 12, 13mm
	<b>1/2"</b>	x8	E10, E11, E12, E14, E16, E18, E20, E24
	<b>1/4"</b>	x5	E4, E5, E6, E7, E8
	<b>1/2"</b>	x2	1/2" - 1/4"
	<b>1/2"</b>	x2	125, 250mm
	<b>1/4"</b>	x2	50, 100mm

	x2	1/2" - 1/4"
	<b>1/2"</b>	x1 adaptador 3/8" H x 1/2" M
	<b>1/2"</b>	x1 8mm
	x5	7, 8, 10, 12, 14mm
	x3	SL8, SL10, SL12
	x2	PH3, PH4
	x2	PZ3, PZ4
	x5	T40, T45, T50, T55, T60
	x5	5, 6, 8, 10, 12mm

	<b>1/2"</b>	x2	16, 21mm
	x3	1.5, 2, 2.5mm	
	x1	1/4"	
	x1	1/4"	
	x2	PH1, PH2	
	x2	PZ1, PZ2	
	<b>1/4"</b>	x4	3, 4, 5, 6mm
	x3	SL4, SL5.5, SL6.5	
	x8	T8, T10, T15, T20, T25, T27, T30	



# CAIXA DE FERRAMENTAS DE 108 PEÇAS COM CHAVES HEXAGONAIS

**54037**

88,00€

6,58

3

108



**54048**

89,00€

7

3

108



ACO  
S2

CrV

108  
PCS

CINCADO

CROMADO

**54048**



DESMANCHA  
DISPONÍVEL

**54037**



DESMANCHA  
DISPONÍVEL



ACO  
S2



## CONTÉM

	<b>1/2"</b> x17	10, 11, 12, 13, 14, 15, 16, 17, 18, 19, 20, 21, 22, 24, 27, 30, 32mm
	<b>1/4"</b> x13	4, 4.5, 5, 5.5, 6, 7, 8, 9, 10, 11, 12, 13, 14mm
	<b>1/2"</b> x5	14, 15, 17, 19, 22mm
	<b>1/4"</b> x8	6, 7, 8, 9, 10, 11, 12, 13mm
	<b>1/2"</b> x8	E10, E11, E12, E14, E16, E18, E20, E24
	<b>1/4"</b> x5	E4, E5, E6, E7, E8
	<b>T2</b> x2	1/2" - 1/4"
	<b>1/2"</b> x2	125, 250mm
	<b>1/4"</b> x2	50, 100mm
	x2	1/2" - 1/4"
	<b>1/2"</b> x1	adaptador 3/8" H x 1/2" M

	<b>1/2"</b> x2	16, 21mm
	<b>1/2"</b> x1	8mm
	x3	1.5, 2, 2.5mm
	x1	1/4"
	x1	1/4"
	x2	PH3, PH4
	x2	PZ3, PZ4
	<b>8mm</b> x5	7, 8, 10, 12, 14mm
	x3	SL8, SL10, SL12
	x5	T40, T45, T50, T55, T60

	x2	PH1, PH2
	x2	PZ1, PZ2
	<b>1/4"</b> x4	3, 4, 5, 6mm
	x3	SL4, SL5.5, SL6.5
	x8	T8, T10, T15, T20, T25, T27, T30



# CAIXA DE FERRAMENTAS DE 94 PEÇAS COM CHAVES HEXAGONAIS

**54038**

86,00€

6 3 108



CINCADO

**54049**

87,00€

6,47 3 108



CROMADO

ACO  
S2

CrV

94  
PCS



54049



DESMANCHA  
DISPONÍVEL

54038



DESMANCHA  
DISPONÍVEL



ACO  
S2

## CONTÉM

	<b>1/2"</b> x18	10, 11, 12, 13, 14, 15, 16, 17, 18, 19, 20, 21, 22, 23, 24, 27, 30, 32mm
	<b>1/4"</b> x13	4, 4.5, 5, 5.5, 6, 7, 8, 9, 10, 11, 12, 13, 14mm
	<b>1/2"</b> x4	14, 15, 17, 19mm
	<b>1/4"</b> x8	6, 7, 8, 9, 10, 11, 12, 13mm
	<b>1/2"</b> x2	1/2" - 1/4"
	<b>1/2"</b> x2	125, 250mm
	<b>1/4"</b> x2	50, 100mm
	x2	1/2" - 1/4"
	<b>1/2"</b> x1	adaptador 3/8" H x 1/2" M

	<b>1/2"</b> x1	8mm
	x3	1.5, 2, 2.5mm
	<b>1/2"</b> x2	16, 21mm
	x2	PH3, PH4
	x2	PZ3, PZ4
	<b>8mm</b> x4	8, 10, 12, 14mm
	x3	SL8, SL10, SL12
	x4	T40, T45, T50, T55
	<b>8mm</b> x1	1/4"

	x1	1/4"
	x1	1/4"
	x1	1/4"
	x2	PH1, PH2
	x2	PZ1, PZ2
	<b>1/4"</b> x4	3, 4, 5, 6mm
	x3	SL4, SL5.5, SL7
	x6	T8, T10, T15, T20, T25, T30

## CAIXA DE FERRAMENTAS DE 74 PEÇAS COM CHAVES DE 12 FACES

53074

5,09

3

108

78,00€



CROMADO



74  
PCS

CrV



DESMANCHA  
DISPONÍVEL

### CONTÉM

	<b>1/2"</b>	x18	10, 11, 12, 13, 14, 15, 16, 17, 18, 19, 20, 21, 22, 23, 24, 27, 30, 32mm
	<b>1/4"</b>	x10	4, 5, 5.5, 6, 7, 8, 10, 11, 12, 13mm
		x2	1/2" - 1/4"
	<b>1/2"</b>	x2	125, 250mm
	<b>1/4"</b>	x1	100mm
		x1	1/2"

	<b>1/2"</b>	x1	adaptador 3/8" H x 1/2" M
	<b>1/2"</b>	x1	21mm
		x3	1.5, 2, 2.5mm
		x1	1/4"
	<b>1/4"</b>	x1	6mm

		x5	PH0, PH1, PH2, PH3, PH4
		x5	PZ0, PZ1, PZ2, PZ3, PZ4
	<b>6mm</b>	x6	3, 4, 5, 6, 8, 10mm
		x5	SL3, SL4, SL5.5, SL6, SL7
		x8	T8, T10, T15, T20, T25, T27, T30, T40
		x4	4, 5, 6, 7mm

## CAIXA FERRAMENTAS 3/8" DE 59 PEÇAS COM CHAVES DE 12 FACES

53075

2,57

10

180

49,90€



CROMADO



CrV

59  
PCS



DESMANCHA  
DISPONÍVEL

### CONTÉM

	<b>3/8"</b>	x17	6, 7, 8, 9, 10, 11, 12, 13, 14, 15, 16, 17, 18, 19, 20, 21, 22mm
		x1	3/8"
	<b>3/8"</b>	x2	75, 150mm
	<b>3/8"</b>	x1	8mm
	<b>3/8"</b>	x1	8mm

		x1	3/8"
		x2	PH3, PH4
		x2	PZ3, PZ4
	<b>8mm</b>	x5	7, 8, 10, 12, 14mm
		x3	8, 10, 12mm
		x5	T40, T45, T50, T55, T60

		x1	1/4"
		x2	PH1, PH2
		x2	PZ1, PZ2
	<b>1/4"</b>	x4	3, 4, 5, 6mm
		x3	4, 5.5, 6.5mm
		x7	T8, T10, T15, T20, T25, T27, T30



# CAIXA DE FERRAMENTAS 3/8" DE 59 PEÇAS COM CHAVES HEXAGONAIS

**51819**

48,00€

2,55 10 180



CINCADO

**53219**

49,00€

2,60 10 180



CROMADO



CrV

59  
PCS

**51819**



DESMANCHA  
DISPONÍVEL

**53219**



DESMANCHA  
DISPONÍVEL



## CONTÉM

	<b>3/8"</b>	x17	6, 7, 8, 9, 10, 11, 12, 13, 14, 15, 16, 17, 18, 19, 20, 21, 22mm
	<b>3/8"</b>	x1	3/8"
	<b>3/8"</b>	x2	75, 150mm
	<b>3/8"</b>	x1	8mm
	<b>3/8"</b>	x1	8mm

	<b>3/8"</b>	x1	3/8"
	<b>PH3, PH4</b>	x2	PH3, PH4
	<b>PZ3, PZ4</b>	x2	PZ3, PZ4
	<b>8mm</b>	x5	7, 8, 10, 12, 14mm
	<b>SL8, SL10, SL12</b>	x3	SL8, SL10, SL12
	<b>T40, T45, T50, T55, T60</b>	x5	T40, T45, T50, T55, T60

	<b>1/4"</b>	x1	1/4"
	<b>PH1, PH2</b>	x2	PH1, PH2
	<b>PZ1, PZ2</b>	x2	PZ1, PZ2
	<b>1/4"</b>	x4	3, 4, 5, 6mm
	<b>SL4, SL5.5, SL6.5</b>	x3	SL4, SL5.5, SL6.5
	<b>T8, T10, T15, T20, T25, T27, T30</b>	x7	T8, T10, T15, T20, T25, T27, T30

## KIT DE DE TOMADAS E BITS DE 130 PCS

**53953**

29,00€

1,50 10 420



CINCADO



CrV

130  
PCS

1/4"

EM EXPOSITOR  
DE 10 UDS

## CONTÉM

	<b>1/4"</b>	x13	4, 4.5, 5, 5.5, 6, 7, 8, 9, 10, 11, 12, 13, 14mm
	<b>1/4"</b>	x1	1/4"
	<b>1/4"</b>	x1	50mm
	<b>1/4"</b>	x1	1/4"
	<b>1/4"</b>	x1	8mm
	<b>1/4"</b>	x1	1/4"
	<b>1/4"</b>	x1	1/4"
	<b>1/4"</b>	x7	1.27, 1.5, 2, 2.5, 3, 4, 5mm

	<b>25mm</b>	x10	1/16, 5/64, 3/32, 7/64, 1/8, 9/64, 5/32, 3/16, 7/32, 1/4
	<b>25mm</b>	x8	1.5, 2, 2.5, 3, 4, 5, 5.5, 6mm
	<b>25mm</b>	x6	5/64, 3/32, 7/64, 1/8, 9/64, 5/32
	<b>25mm</b>	x6	2, 2.5, 3, 4, 5, 6mm
	<b>25mm</b>	x9	3, 4, 4.5, 5, 5.5, 6, 6.5, 7, 8mm
	<b>50mm</b>	x2	4, 6mm
	<b>25mm</b>	x10	PH0(x2), PH1(x2), PH2(x4), PH3(x2)
	<b>50mm</b>	x2	PH1, PH2
	<b>25mm</b>	x10	PZ0(x2), PZ1(x2), PZ2(x4), PZ3(x2)

	<b>25mm</b>	x10	T8, T10, T15, T20, T25, T27, T30, T35, T40, T45
	<b>25mm</b>	x9	T8, T10, T15, T20, T25, T27, T30, T35, T40
	<b>25mm</b>	x3	M5, M6, M8
	<b>25mm</b>	x3	6, 8, 10mm
	<b>25mm</b>	x3	C1, C2, C3
	<b>25mm</b>	x4	1, 2, 3, 4mm
	<b>25mm</b>	x4	4, 6, 8, 10mm
	<b>25mm</b>	x4	0, 1, 2, 3mm

## CAIXA DE FERRAMENTAS COM 56 PEÇAS

**50566** 1,19 10 240  
32,00€

CINCADO

**53101** 1,26 10 270  
35,00€

CROMADO



CrV

56  
PCS



DESMANCHA  
DISPONÍVEL



DESMANCHA  
DISPONÍVEL



### CONTÉM

	1/4"	x13	4, 4.5, 5, 5.5, 6, 7, 8, 9, 10, 11, 12, 13, 14mm
		x1	1/4"
	1/4"	x2	50, 100mm
		x1	1/4"
		x1	1/4"

		x1	1/4"
	1/4"	x1	6mm
		x3	PH0, PH1, PH2
	6mm	x3	PZ0, PZ1, PZ2
		x6	3, 4, 5, 6, 7, 8mm
	6mm	x1	1/4"

		x4	SL4, SL5, SL6, SL7
	6mm	x3	M5, M6, M8
		x8	T8, T10, T15, T20, T25, T27, T30, T40
		x8	T8, T10, T15, T20, T25, T27, T30, T40

## CAIXA DE FERRAMENTAS COM 56 PEÇAS

**53102** 1,28 10 270  
39,00€

CROMADO



CrV

56  
PCS



DESMANCHA  
DISPONÍVEL



### CONTÉM

	1/4"	x13	4, 4.5, 5, 5.5, 6, 7, 8, 9, 10, 11, 12, 13, 14mm
		x1	1/4"
	1/4"	x2	50, 100mm
		x1	1/4"
		x1	1/4"

	1/4"	x1	
	1/4"	x1	6mm
		x3	PH0, PH1, PH2
	6mm	x3	PZ0, PZ1, PZ2
		x6	3, 4, 5, 6, 7, 8mm
	6mm	x1	1/4"

		x4	SL4, SL5, SL6, SL7
	6mm	x3	M5, M6, M8
		x8	T8, T10, T15, T20, T25, T27, T30, T40
		x8	T8, T10, T15, T20, T25, T27, T30, T40

## CAIXA DE FERRAMENTAS COM 46 PEÇAS COM CHAVES HEXAGONAIS

**53201** 1,45 5 10 300  
34,00€

CROMADO



DESMANCHA  
DISPONÍVEL

CrV

46  
PCS



### CONTÉM

	x6	3, 4, 5, 6, 7, 8mm		x3	PZ1, PZ2, PZ3
	x3	SL4, SL5.5, SL7		x6	T10, T15, T20, T25, T30, T40
	x3	PH1, PH2, PH3			

	1/4"	x13	4, 4.5, 5, 5.5, 6, 7, 8, 9, 10, 11, 12, 13, 14mm
		x1	1/4"
	1/4"	x2	50, 100mm
	1/4"	x1	
		x4	1.27, 1.5, 2.0, 2.5mm
		x1	1/4"
		x1	1/4"
	1/4"	x1	150mm
	6mm	x1	1/4"



# CAIXA DE FERRAMENTAS DE 61 PEÇAS CHAVES SPLINE DE 1/4" E 1/2"

**52722**

98,00€



CINCADO

**53108**

99,00€



CROMADO



CrV

61  
PCS

- Útil para:



**52722**

DESMANCHA DISPONÍVEL



**53108**

DESMANCHA DISPONÍVEL

## CONTÉM

	1/2"	x11	14, 15, 16, 17, 18, 19, 22, 24, 27, 30, 32mm		1/2"	x1	adaptador 3/8" H x 1/2" M		6mm	x3	PH1, PH2, PH3
	1/4"	x12	4, 4.5, 5, 5.5, 6, 7, 8, 9, 10, 11, 12, 13mm		1/2"	x2	16, 21mm		6mm	x3	PZ1, PZ2, PZ3
	T2	x2	1/2" - 1/4"		1/4"	x1	6mm		6mm	x5	3, 4, 5, 6, 8mm
	1/2"	x2	125, 250mm			x3	1.5, 2, 2.5mm		6mm	x3	SL4, SL5.5, SL7
	1/4"	x2	50, 100mm			x1	1/4"		6mm	x5	T10, T15, T20, T25, T30
		x2	1/2" - 1/4"			x1	1/4"		6mm	x1	1/4"

# CAIXA DE FERRAMENTAS DE 21 PEÇAS COM CHAVES DE 1/2"

**53554**

54,00€



12 VIAS

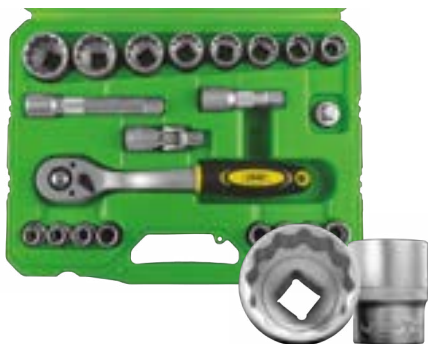

**53554**

DESMANCHA DISPONÍVEL

**52723**

56,00€



HEXAGONAIS

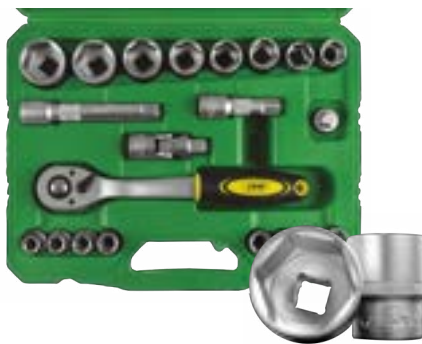

**52723**

DESMANCHA DISPONÍVEL

**52721**

55,00€



SPLINE

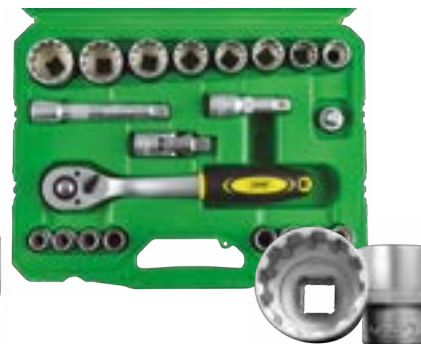

**52721**

DESMANCHA DISPONÍVEL

CINCADO

21  
PCS

CrV

## CONTÉM

	1/2"	x16	10, 11, 12, 13, 14, 15, 16, 17, 18, 19, 21, 22, 24, 27, 30, 32mm		T2	x1	1/2"		1/2"	x1	
	1/2"	x2	75, 125mm		1/2"	x1	adaptador 3/8" H x 1/2" M				

IVA não incluído

JBM

www.jbmcamp.com

17

# CAIXA DE FERRAMENTAS DE 72 PEÇAS COM CHAVES HEXAGONAIS

**51818**

95,00€

7,25 3 63



CINCADO

**53106**

99,90€

7,2 3 60



CROMADO



CrV

72  
PCS



**53106**



DESMANCHA  
DISPONÍVEL

**51818**



DESMANCHA  
DISPONÍVEL

## CONTÉM

	<b>1/2"</b>	x13	10, 11, 12, 13, 14, 15, 17, 19, 22, 24, 27, 30, 32mm
	<b>1/4"</b>	x10	4, 5, 6, 7, 8, 9, 10, 11, 12, 13mm
	<b>1/4"</b>	x5	5, 6, 7, 8, 9mm
	ref. 53106	x2	1/2", 1/4"
	ref. 51818	x2	1/2", 1/4"
	<b>1/2"</b>	x1	125mm
	<b>1/4"</b>	x1	75mm

	x2	1/2" - 1/4"
	<b>1/2"</b>	x2 16, 21mm
	<b>1/4"</b>	x1 6mm
	x8	10, 11, 12, 13, 14, 15, 17, 19mm
	x3	1.5, 2, 2.5mm
	x1	1/4"
	x2	PH6x40mm, PH6x100mm
	x3	SL6x40mm, SL6x100mm, SL8x200mm

	x1	
	x1	300gr
	x1	
	x1	
	x4	SL3, SL4, SL5, SL6
	<b>6mm</b>	x3 PH1, PH2, PH3
	x7	T10, T15, T20, T25, T27, T30, T40

# CAIXA DE FERRAMENTAS DE 41 PEÇAS COM CHAVES HEXAGONAIS

**52713**

89,00€

6,3 4 96



41  
PCS

CrV

CINCADO

## CONTÉM

	<b>1/2"</b>	x11	10, 12, 13, 14, 15, 17, 19, 22, 24, 27, 30mm
	<b>1/2"</b>	x2	16, 21mm
		x1	1/2"
	<b>1/2"</b>	x1	125mm
	<b>1/2"</b>	x1	
	<b>1/2"</b>	x1	adaptador 3/8" H x 1/2" M
	<b>1/2"</b>	x8	7, 8, 10, 12, 13, 14, 17, 19mm
		x4	6, 8, 10, 12mm
		x1	PH2x100mm
		x1	SL6x100mm

	x1	6"
	x1	20x200mm
	x1	6-24V, 110mm
	x1	8"
	x2	8x10, 12x13mm
	x1	8x10mm
	x1	75x300mm
	x1	300gr
	x1	6x150mm



DESMANCHA  
DISPONÍVEL



# CAIXA FERRAMENTAS DE 82 PEÇAS COM CHAVES HEXAGONAIS

**53647**  
99,00€

6,13 3 108

CROMADO



CrV

82  
PCS



## CONTÉM

	<b>1/2"</b>	x12	13, 14, 15, 16, 17, 18, 19, 22, 24, 27, 30, 32mm
	<b>1/4"</b>	x13	4, 4.5, 5, 5.5, 6, 7, 8, 9, 10, 11, 12, 13, 14mm
	<b>PH</b>	x2	1/2" - 1/4"
	<b>1/2"</b>	x2	125, 250mm
	<b>1/4"</b>	x2	50, 100mm
		x2	1/2" - 1/4"
	<b>1/2"</b>	x1	adaptador 3/8" H x 1/2" M

	<b>1/2"</b>	x2	16, 21mm
	<b>1/2"</b>	x1	8mm
		x9	8, 10, 11, 12, 13, 14, 17, 19, 22mm
		x1	150mm
		x1	1/4"
		x1	1/4"

	<b>8mm</b>	x2	PH3, PH4
		x2	PZ3, PZ4
		x4	8, 10, 12, 14mm
		x3	SL8, SL10, SL12
		x4	T40, T45, T50, T55
		x1	1/4"
	<b>1/4"</b>	x2	PH1, PH2
		x2	PZ1, PZ2
		x4	3, 4, 5, 6mm
		x3	SL4, SL5.5, SL7
		x6	T8, T10, T15, T20, T25, T30

# CONJUNTO DE FERRAMENTAS NA CAIXA DE FERRO DE 64 PEÇAS

**53565**  
258,00€

16,50 1 19

290mm 495mm 200mm

CrV

64  
PCS

CINCADO



## CONTÉM

	<b>1/2"</b>	x18	10, 11, 12, 13, 14, 15, 16, 17, 18, 19, 20, 21, 22, 23, 24, 27, 30, 32mm
	<b>PH</b>	x1	1/2"
		x1	1/2"
	<b>1/2"</b>	x3	76mm, 127mm, 254mm
	<b>1/2"</b>	x1	255mm
	<b>1/2"</b>	x1	21mm
		x1	457mm

		x18	6, 7, 8, 9, 10, 11, 12, 13, 14, 15, 16, 17, 18, 19, 20, 21, 22, 24mm
		x9	1.5, 2, 2.5, 3, 4, 5, 6, 8, 10mm
	<b>PH</b>	x3	PH1x100mm, PH2x150mm, PH3x200mm
	<b>SL</b>	x3	SL5x100mm, SL6x150mm, SL8x200mm
		x1	250mm
		x1	180mm
		x1	200mm
		x1	180mm



# CAIXA DE FERRAMENTAS DE 303 PEÇAS COM CHAVES HEXAGONAIS

53212

9,45

2

48

188,00€



CrV

303  
PCS

CROMADO



## CONTÉM

	<b>1/2"</b>	x18	10, 11, 12, 13, 14, 15, 16, 17, 18, 19, 20, 21, 22, 23, 24, 27, 30, 32mm
	<b>1/4"</b>	x13	4, 4.5, 5, 5.5, 6, 7, 8, 9, 10, 11, 12, 13, 14mm
		x2	1/2" - 1/4"
	<b>1/2"</b>	x2	125, 250mm
	<b>1/4"</b>	x2	50, 100mm
	<b>1/2"</b>	x1	8mm
	<b>1/4"</b>	x1	6mm
	<b>1/2"</b>	x1	adaptador 3/8" H x 1/2" M
	<b>1/2"</b>	x2	16, 21mm
		x2	1/2" - 1/4"
		x1	1/4"
		x2	SL3.0 x 50mm, SL2.5 x 50mm
		x3	PH0x50mm, PH00x50mm, PH000x50mm
		x2	SL4.0x100mm, SL6.5x125mm
		x2	PH1x80mm, PH2x100mm

	<b>6mm</b>	x9	1, 5, 2, 2.5, 3, 4, 5, 5.5, 6, 8mm
	<b>6mm</b>	x10	1/16, 5/64, 3/32, 7/64, 1/8, 9/64, 5/32, 3/16, 7/32, 1/4
	<b>8mm</b>	x4	H5.5, H6.5, H7, H8
	<b>6mm</b>	x6	5/64, 3/32, 7/64, 1/8, 9/64, 5/32
	<b>6mm</b>	x6	2, 2.5, 3, 4, 5, 6mm
	<b>6mm</b>	x9	SL3, SL4, SL4.5, SL5, SL5.5, SL6, SL6.5, SL7, SL8
	<b>8mm</b>	x4	SL5.5, SL6.5, SL7, SL8
	<b>6mm</b>	x10	PH0 (x2), PH1 (x2), PH2 (x4), PH3 (x2)
	<b>8mm</b>	x2	PH3, PH4
	<b>6mm</b>	x10	PZ0 (x2), PZ1 (x2), PZ2 (x4), PZ3 (x2)
	<b>8mm</b>	x2	PZ3, PZ4
	<b>6mm</b>	x10	T8, T10, T15, T20, T25, T27, T30, T35, T40, T45
	<b>8mm</b>	x8	T25, T27, T30, T35, T40 (x2), T45, T50
	<b>6mm</b>	x9	T8, T10, T15, T20, T25, T27, T30, T35, T40
	<b>6mm</b>	x3	5, 6, 8mm
	<b>8mm</b>	x4	5, 6, 8, 10mm
		x3	6, 8, 10
		x3	C1, C2, C3
	<b>6mm</b>	x4	1, 2, 3, 4
		x4	4, 6, 7, 10mm
		x4	S0, S1, S2, S3

		x7	1.27, 1.5, 2, 2.5, 3, 4, 5mm		
		x13	1.5, 2, 2.5, 3, 3.2, 3.5, 4, 4.5, 4.8, 5, 5.5, 6, 6.5mm		
		x1		x1	
		x1		x1	
		x10		x1	300g
		x1	8"		x1
		x1	3m		
		x6	SL1.5, SL2, SL2.5, SL3, SL3.5, SL4		
		x4	PH000, PH00, PH0, PH1		
		x2	PZ0, PZ1		
		x8	T5, T6, T7, T8, T9, T10, T15, T20		
		x1			
		x23			x10
		x22			x10



DESMANCHA  
DISPONÍVEL



# CAIXAS DE FERRAMENTAS DE ALUMÍNIO

## CAIXA DE FERRAMENTAS DE ALUMÍNIO 159PCS

53159

279,00€

13,3

1

32



CrV

1/2"

1/4"

159  
PCS

CINCADO



### CONTÉM



	1/2"	x14	14, 15, 16, 17, 18, 19, 20, 21, 22, 23, 24, 27, 30, 32mm
	1/4"	x10	4, 5, 6, 7, 8, 9, 10, 11, 12, 13mm
		x2	1/4" - 1/2"
	1/2"	x2	50, 100mm
	1/4"	x2	125, 250mm
	1/4"	x1	150mm
		x2	1/4" - 1/2"
	1/2"	x1	adaptador 3/8" H x 1/2" M
		x2	1/4" - 1/2"
	1/4"	x1	250mm
	1/4"	x1	110mm
	1/2"	x2	16, 21mm
		x1	1/4"

		x9	8, 10, 11, 12, 13, 15, 17, 19, 22mm
		x9	1,5, 2, 2,5, 3, 4, 5, 6, 8, 10mm
		x1	100-250V
		x1	
		x2	PH1x80, PH2x10mm
		x4	SL3x75, SL4x100, SL6.5x125, SL8x150mm
		x1	PH00x50mm
		x1	SL2.5x50mm
		x1	250mm
		x1	160mm
		x1	180mm
		x1	160mm
		x1	200mm
		x1	7" (180mm)
		x1	220mm
		x1	160mm

		x1	
		x6	1,5mm
		x1	
		x1	300gr
		x1	3m
		x1	200mm
		x5	
		x1	18mm
		x10	
		x40	6.35mm
		x15	8mm

# CAIXAS DE FERRAMENTAS DE ALUMÍNIO

## CAIXA DE FERRAMENTAS DE 198 PEÇAS COM CHAVES HEXAGONAIS

53928

13,50

1

32

258,00€



CrV

1/2"

1/4"

198  
PCS



DESMANCHA  
DISPONÍVEL

### CONTÉM



	1/2"	x10	10, 11, 12, 13, 14, 15, 17, 19, 22, 24mm
	1/4"	x9	4, 5, 6, 7, 8, 9, 10, 11, 12mm
	T2	x2	1/2" - 1/4"
	1/2"	x2	125, 250mm
	1/4"	x2	50, 100mm
	x2	1/2" - 1/4"	
	1/2"	x1	adaptador 3/8" H x 1/2" M
	x1	1/4"	
	1/4"	x1	6mm
	1/2"	x2	16, 21mm

	x9	1,5, 2, 2,5, 3, 4, 5, 6, 8, 10mm
	x9	8, 10, 11, 12, 13, 14, 17, 19, 22mm
	x2	PH1x80mm, PH2x100mm
	x4	SL3.0x75mm, SL4.0x100mm, SL6.5x125mm, 8x150mm
	x1	PH00, SL2
	x1	PH000, SL1.5
	x1	T6, T10
	x30	6.35mm
	x1	
	x60	
	x11	
	x10	

	x1	100-250V		x1	250mm
	x1	200mm		x1	180mm
	x1	200mm		x1	180mm
	x1	160mm		x1	150mm
	x1	200mm		x1	
	x4			x5	
	x1			x1	300gr.
	x1	18mm		x1	
	x1			x1	
	x1			x1	5m



# CAIXAS DE FERRAMENTAS DE ALUMÍNIO

## CAIXA DE FERRAMENTAS DE ALUMÍNIO 108PCS

**53158**

148,00€

8,60

1

32

3/8"

1/4"

**53444**

158,00€

8,2

1

36

1/2"

1/4"



CrV

**108**  
PCS

1/2"

3/8"

1/4"

CINCADO



**53158**



DESMANCHA  
DISPONÍVEL



**53444**



DESMANCHA  
DISPONÍVEL

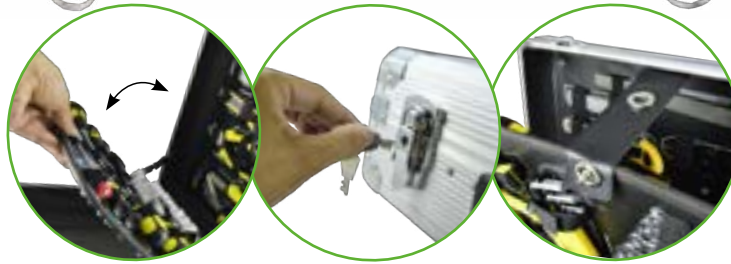

### CONTÉM



	1/4"	x8	4, 4.5, 5, 5.5, 6, 7, 8, 9mm
	3/8"	x9	10, 11, 12, 13, 14, 15, 17, 18, 19mm
	1/2"	x1	ref. 53158
	3/8"	x1	ref. 53444
	3/8"	x2	75, 150mm
	1/2"	x2	75, 150mm
	1/4"	x1	adaptador 3/8" H x 1/4" M
	1/4"	x1	25mmL
	1/4"	x1	1/4"

	3/8"	x1	16mm
	x2	6x7, 8x9, 10x11, 12x13, 14x15, 16x17, 18x19, 20x22mm	
	x2	1.5, 2, 2.5, 3, 4, 5, 6, 8, 10mm	
	x2	PH1x80, PH2x100mm	
	x4	SL3.5x75, SL4x100, SL6.5x125, SL8x150mm	
	x1	PH00x50mm	
	x1	SL2.5x50mm	

	x1	100-250V
	x1	250mm
	x1	180mm
	x1	160mm
	x1	160mm
	x1	220mm
	x1	18mm
	x10	
	x1	
	x6	1,5mm
	x1	300gr
	x31	
	x1	
	x1	7"
	x1	3m



## CAIXA DE FERRAMENTAS COM 22 PEÇAS AUTOCLER 1" HEXAGONAIS

51616

43,45

1

24



359,00€



51855

41,1

1

24



359,00€



CrV

1"

22  
PCS

CINCADO

CAIXA METÁLICA

### CONTÉM

	1"	x17	36, 38, 41, 46, 50, 54, 55, 58, 60, 63, 65, 67, 70, 71, 75, 77, 80mm
	1"	x1	650mm
	1"	x2	205, 410mm
	x1	1"	
		x1	1"

51616



DESMANCHA DISPONÍVEL

51855



DESMANCHA DISPONÍVEL

## CAIXA DE FERRAMENTAS COM 22 PEÇAS DE AUTOCLER DE 3/4"

53727

14,65

1

40



188,00€



53728

13,9

1

40



188,00€



3/4"

21  
PCS

CrV

CINCADO

### CONTÉM

	3/4"	x16	19, 21, 22, 23, 24, 26, 27, 29, 30, 32, 35, 36, 38, 41, 46, 50mm
	3/4"	x1	495mm
	3/4"	x3	100, 200, 400mm
	3/4"	x1	445mm

53728



DESMANCHA DISPONÍVEL

53727

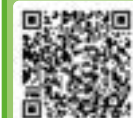

DESMANCHA DISPONÍVEL

## CAIXA DE FERRAMENTAS DE 39 PEÇAS HEX. DE PERFIL BAIXO

52418

3,61

5

100



144,00€



39  
PCS

CrV

CROMADO

### CONTÉM

	13mm	x12	4, 4.5, 5, 5.5, 6, 7, 8, 9, 10, 11, 12, 13mm
	19mm	x10	10, 11, 12, 13, 14, 15, 16, 17, 18, 19mm
	22mm	x5	20, 21, 22, 23, 24mm
	22mm - 1/2"	x3	27, 30, 32mm
		x3	13, 19, 22mm
	1/4"	x1	13mm
	3/8"	x1	19mm
	1/2"	x1	22mm
		x3	13, 19, 22mm





## CAIXA DE FERRAMENTAS DE 15 CHAVES PARA PARAFUSOS COMPRIDOS

51617

67,50€

1,06

18

320



CrV

3/8"

15  
PCS

CROMADO



OCUPA UM  
ESPAÇO MÍNIMO

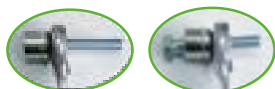

### CONTÉM

		19mm x10	10, 11, 12, 13, 14, 15, 16, 17, 18, 19mm
		19mm x1	75mm
		x2	1/4" 3/8"
		19mm x1	180mm

## CAIXA DE FERRAMENTAS DE 17 CHAVES PARA PARAFUSOS COMPRIDOS

50623

53,50€

0,63

10

320



CrV

1/4"

17  
PCS

CROMADO



OCUPA UM  
ESPAÇO MÍNIMO



### CONTÉM

		13mm x13	4, 4.5, 5, 5.5, 6, 7, 8, 9, 10, 11, 12, 13, 14mm
		13mm x1	75mm
		x1	1/4"
		13mm x1	145mm

## CONJUNTO DE BITS TORX DE 6 PEÇAS 1/2" TIPO E EXTRA LONGOS

53915

57,50€

2

10



CINCADO

### CONTÉM

		1/2" x6	E10, E12, E14, E16, E18, E20
--	--	---------	------------------------------



E12 Soquete para cabeça do bloco de cilindros BMW:  
- Motor M42, 1,8 L, 4 cilindros, 16 V, modelo 318 (1989)  
- Motor M50, 2.0L, 2.5L, 6 cilindros, 24V, modelos 520i, 525i (1991)



CABEÇA COM  
ESCURECIMENTO

140mm

6  
PCS

1/2"

CrV



## CAIXA DE 28 CHAVES TORX

51930

39,00€

2,19

10

240



CINCADO

53061

41,00€

2,19

5

10

180



1/4"

3/8"

1/2"

28  
PCS

CrV

### CONTÉM

		1/4" x5	E4, E5, E6, E7, E8
		3/8" x5	E10, E11, E12, E14, E16
		1/2" x4	E18, E20, E22, E24
		1/4" x5	E4, E5, E6, E7, E8
		3/8" x5	E10, E11, E12, E14, E16
		1/2" x4	E18, E20, E22, E24

51930



DESMANCHA  
DISPONÍVEL



53061



DESMANCHA  
DISPONÍVEL

## CAIXA DE 12 PEÇAS 1/2" PONTA DE TORX

51261

1,62 10 360

34,00€



CINCADO

51261



DESMANCHA  
DISPONÍVEL

1/2"

12  
PCS

CrV



CONTÉM

1/2"	x6	T20, T25, T30, T40, T45, T50
	x1	T55
	x5	T60, T70, T80, T90, T100

## CAIXA DE 12 PEÇAS 1/2" 12 FACES

51384

1,55 10 360

34,00€



CINCADO

51384



DESMANCHA  
DISPONÍVEL

12  
PCS

1/2"

CrV



CONTÉM

1/2"	x6	M4, M5, M6, M7, M8, M9
	x1	M10
	x5	M12, M14, M16, M18, M20

## CAIXA DE 12 PEÇAS 1/2" HEXAGONAL

51260

1,92 10 360

34,00€



CINCADO

51260



DESMANCHA  
DISPONÍVEL

12  
PCS

1/2"

CrV



CONTÉM

1/2"	x6	H5, H6, H7, H8, H10, H12
	x1	H14
	x5	H16, H17, H18, H19, H22

## CAIXA DE 6 PEÇAS 1/2" PONTA TORX INTERIOR

51410

0,38 5 20 500

36,00€



CINCADO

T55, T60, T70,  
T80, T90, T100

1/2"

CrV

6  
PCS



## CAIXA DE 6 PEÇAS 1/2" 12 FACES INTERIOR / PONTA XZN

51409

0,34 5 20 500

36,00€



CINCADO

M10, M12, M14,  
M16, M18, M20

1/2"

CrV

6  
PCS





## JOGO DE PONTAS 12 FACES

**52603**  
74,00€



**26**  
PCS



**52606**  
88,00€



**32**  
PCS

CrV 1/2"



### CONTÉM



1/2"

x8 55mmL	M5, M6, M8, M9, M10, M12, M14, M16
x7 100mmL	M5, M6, M8, M9, M10, M12, M14
x7 140mmL	M5, M6, M8, M9, M10, M12, M14
x4 200mmL	M8, M10, M12, M14

**52603**



DESMANCHA  
DISPONÍVEL

### CONTÉM



1/2"

x9 55mmL	M5, M6, M7, M8, M9, M10, M12, M13, M14
x9 100mmL	M5, M6, M7, M8, M9, M10, M12, M13, M14
x7 140mmL	M7, M8, M9, M10, M12, M13, M14
x7 200mmL	M7, M8, M9, M10, M12, M13, M14

**52606**



DESMANCHA  
DISPONÍVEL

## JOGO DE PONTAS HEXAGONAIS

**52604**  
78,00€



**30**  
PCS



**52605**  
78,00€



**32**  
PCS

CrV 1/2"



### CONTÉM



1/2"

x9 55mmL	5, 6, 7, 8, 10, 12, 14, 17, 19mm
x8 100mmL	5, 6, 7, 8, 10, 11, 12, 13mm
x7 140mmL	5, 6, 7, 8, 10, 12, 14mm
x6 200mmL	5, 6, 7, 8, 10, 12mm

**52604**



DESMANCHA  
DISPONÍVEL

### CONTÉM



1/2"

x10 55mmL	T20, T25, T27, T30, T40, T45, T50, T55, T60, T70
x10 100mmL	T20, T25, T27, T30, T40, T45, T50, T55, T60, T70
x6 140mmL	T40, T45, T50, T55, T60, T70
x6 200mmL	T40, T45, T50, T55, T60, T70

**52605**



DESMANCHA  
DISPONÍVEL

## CAIXA FERRAMENTAS DE 55 PUNTAS HEAVY DUTY

52753

2,96

4

184

98,00€



S-2

3/8"

1/2"

55  
PCS

### CONTÉM

	3/8"	x1	10mm
	1/2"	x2	10, 14mm
	30mm	x9	4, 5, 6, 7, 8, 10, 12, 14, 16mm - ISO 2136
	75mm	x9	4, 5, 6, 7, 8, 10, 12, 14, 16mm - ISO 2136
	30mm	x10	T20, T25, T30, T40, T45, T50, T55, T60, T70, T80 - DIN 2325
	75mm	x10	T20, T25, T30, T40, T45, T50, T55, T60, T70, T80 - DIN 2325
	30mm	x7	M5, M6, M8, M10, M12, M14, M16 - DIN 2325
	75mm	x7	M5, M6, M8, M10, M12, M14, M16 - DIN 2325

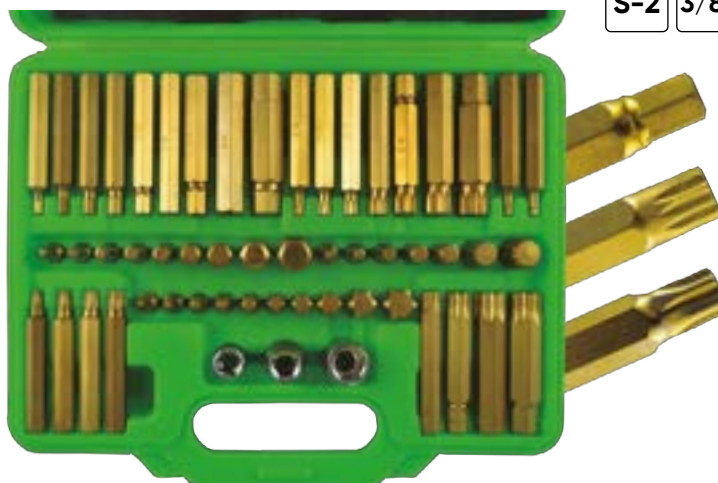

DESMANCHA  
DISPONÍVEL

## CAIXA FERRAMENTAS DE 42 PUNTAS PARA PARAFUSOS TORX, UMBRAKO E 12 FACES

50983

1,77

5

200

48,00€



50985

1,74

5

240

59,00€



S-2

3/8"

1/2"

42  
PCS



INVIOLÁVEL

### CONTÉM

	3/8"	x1	10mm
	1/2"	x1	10mm
	30mm	x7	4, 5, 6, 7, 8, 10, 12mm
	75mm	x7	4, 5, 6, 7, 8, 10, 12mm
	30mm	x8	T20, T25, T30, T40, T45, T50, T55, T60
	75mm	x8	T20, T25, T30, T40, T45, T50, T55, T60
	30mm	x5	M5, M6, M8, M10, M12
	75mm	x5	M5, M6, M8, M10, M12
	30mm	x7	4, 5, 6, 7, 8, 10, 12mm
	75mm	x7	4, 5, 6, 7, 8, 10, 12mm
	30mm	x8	T20, T25, T30, T40, T45, T50, T55, T60
	75mm	x8	T20, T25, T30, T40, T45, T50, T55, T60
	30mm	x5	M5, M6, M8, M10, M12
	75mm	x5	M5, M6, M8, M10, M12

50983

DESMANCHA  
DISPONÍVEL



50985

DESMANCHA  
DISPONÍVEL

## CAIXA DE FERRAMENTAS DE 75 CHAVES

52550

3,61

4

72

89,00€



S-2

3/8"

1/2"

75  
PCS

CrV

### CONTÉM

	3/8"	x1	10mm
	1/2"	x2	10mm
	30mm	x7	4, 5, 6, 7, 8, 10, 12mm
	75mm	x7	4, 5, 6, 7, 8, 10, 12mm
	30mm	x8	T20, T25, T30, T40, T45, T50, T55, T60
	75mm	x8	T20, T25, T30, T40, T45, T50, T55, T60
	30mm	x5	M5, M6, M8, M10, M12
	75mm	x5	M5, M6, M8, M10, M12
	30mm	x8	M5, M6, M7, M8, M9, M10, M12, M14
	75mm	x5	M5, M6, M8, M10, M12
	30mm	x8	T20, T25, T30, T40, T45, T50, T55, T60
	75mm	x8	T20, T25, T30, T40, T45, T50, T55, T60

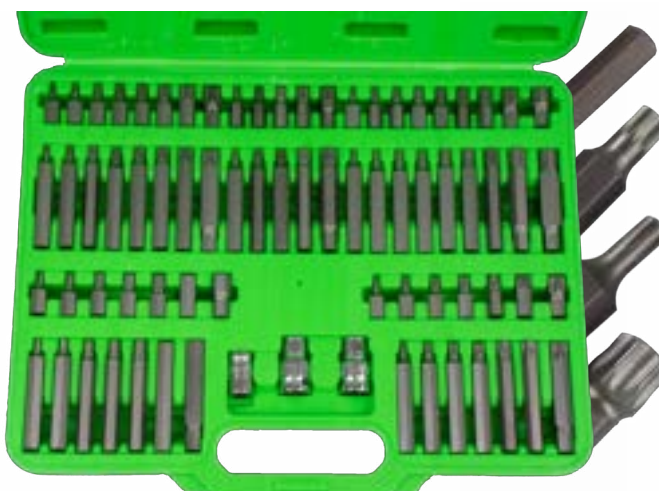

DESMANCHA  
DISPONÍVEL



# KIT DE 208 BITS DE CHAVE DE FENDA

53574

43,50€

2,29

6

216



208  
PCS

CrV

## CONTÉM

25mmL	x12	1,5, 2, 2,5, 3, 3,5, 4, 4,5, 5, 5,5, 6, 7, 8mm	25mmL	x4	4, 6, 8, 10mm
50mmL	x10	1/16, 5/64, 3/32, 7/64, 1/8, 9/64, 5/32, 3/16, 7/32, 1/4	50mmL	x4	4, 6, 8, 10mm
75mmL	x5	2,5, 3, 4, 5, 6mm	25mmL	x4	1, 2, 3, 4mm
25mmL	x5	2,5, 3, 4, 5, 6mm	50mmL	x4	1, 2, 3, 4mm
50mmL	x18	PH00, PH0, PH1(x5), PH2(x5), PH3(x5), PH4	25mmL	x6	2, 2,5, 3, 4, 5, 6mm
75mmL	x3	PH1, PH2, PH3	25mmL	x6	5/64, 3/32, 7/64, 1/8, 9/64, 5/32
25mmL	x3	PH1, PH2, PH3	25mmL	x13	T5, 6, 7, 8, 9, 10, 15, 20, 25, 27, 30,40,45
50mmL	x17	PZ00, PZ0, PZ1(x5), PZ2(x5), PZ3(x4), PZ4	25mmL	x3	1, 2, 3mm
75mmL	x3	PZ1, PZ2, PZ3	25mmL	x4	0, 1, 2, 3mm
25mmL	x3	PZ1PZ2,PZ3	25mmL	x4	0, 1, 2, 3mm
25mmL	x14	T5, T6, T7, T8, T9, T10, T15, T20, T25, T27, T30, T35, T40, T45	25mmL	x3	M5, M6, M8
50mmL	x7	T10, T15, T20, T25, T27, T30, T40	25mmL	x9	TS10, TS15, TS20, TS25, TS27, TS30, TS40, TS45, TS50
75mmL	x7	T10, T15, T20, T25, T27, T30, T40	25mmL	x9	SL2, SL2.5, SL3, SL3.5, SL4, SL4.5, SL5, SL5.5, SL6, SL6.5, SL7, SL8
25mmL	x3	6, 8, 10mm	25mmL	x12	
50mmL	x3	6, 8, 10mm			



mm	x10	4, 5, 6, 7, 8, 9, 10, 11, 12, 13
"	x10	5/32, 3/16, 7/32, 1/4, 9/32, 5/16, 11/32, 3/8, 7/16, 1/2
6mm	x1	1/4"
	x1	Adaptador

# SET DE PUNTA PARA MANUAL

52539

59,00€

1,90

5

128



ALLEN 8

CrV

85  
PCS

## CONTÉM

8mm	x2	PH3, PH4
	x2	PZ3, PZ4
	x5	7, 8, 10, 12, 14mm
	x3	SL8, SL10, SL12
	x5	T40, T45, T50, T55, T60



DESMANCHA  
DISPONÍVEL

# SET DE PUNTAS DE CHAVE DE FENDA

52538

62,00€

2,07

16

128



CrV

1/4"

90  
PCS

## CONTÉM

1/4"	x2	PH1, PH2
	x2	PZ1, PZ2
	x5	3, 4, 5, 6mm
	x3	SL4, SL5.5, SL6.5
	x5	T8, T10, T15, T20, T25, T27, T30



DESMANCHA  
DISPONÍVEL

# JOGO DE 6 ADAPTADORES

51333

18,00€

0,5

5

40

640



CrV

6  
PCS

CINCADO

M	F
1/2"	3/4"
3/8"	1/2"
1/4"	3/8"
3/8"	1/4"
1/2"	3/8"
3/4"	1/2"



DESMANCHA DISPONÍVEL

REF.	DESCRIÇÃO	€
11360	1/4H - 3/8M	0,02 2,60€
11361	1/4M - 3/8H	0,05 3,20€
11362	3/8H - 1/2M	0,13 5,20€
11363	1/4H - 3/8M	0,05 3,90€
11364	1/2H - 3/8M	0,05 4,50€
11365	3/4H - 1/2M	0,14 9,40€



# CONJUNTO DE 6 CABEÇAS DE CHOQUE

53743

34,00€

0,80

5

20



6  
PCS

M →

F →



DESMANCHA DISPONÍVEL

REF.	mm	€
14749	1/4" F - 3/8" M	2,00€
14750	3/8" M - 1/4" F	2,00€
14751	3/8" M - 1/2" F	4,00€
14752	1/2" F - 3/8" M	4,00€

M	F
3/4"	1/2"
1/2"	3/4"
3/8"	1/4"
1/4"	3/8"
1/2"	3/8"
3/8"	1/2"

# FERRAMENTAS EM POLEGADA

## CAIXA DE FERRAMENTAS DE 35 PEÇAS EM POLEGADA

**53076**

4,97 3 108

72,00€



CrV

1/2"

1/4"

**35**  
PCS



**53076**



DESMANCHA  
DISPONÍVEL

CINCADO

CONTÉM

	1/2" x17	5/16", 3/8", 7/16", 1/2", 9/16", 19/32", 5/8", 11/16", 3/4", 13/16", 7/8", 15/16", 1", 1-1/16", 1-1/8", 1-3/16", 1-1/4"
	1/4" x8	3/16", 7/32", 1/4", 9/32", 5/16", 11/32", 3/8", 7/16"
	53076 x2	1/2" - 1/4"

	1/2" x2	5", 10"
	1/4" x1	3"
	x1	1/2"

	x1	1/4"
	x2	1/2" - 1/4"
	x1	1/4"

## JOGO DE 17 CHAVES DE BOCAS LUNETA EM POLEGADA

**51890**

3,92 4 192

78,00€



CINCADO

**52972**

4,60 4

79,00€



CROMADO

5/16", 3/8", 7/16", 1/2", 9/16", 19/32", 5/8", 11/16", 3/4", 13/16", 7/8", 15/16", 1", 1-1/16", 1-1/8", 1-3/16", 1-1/4"

**17**  
PCS

CrV



52972

51890



## JOGO DE CHAVES UMBRAKO EM POLEGADA

**54005**

0,37 10 40 1.120

14,00€



**9**  
PCS

1/16", 5/64", 3/32", 1/8", 5/32", 3/16", 1/4", 5/16", 3/8"

↑72-170mm

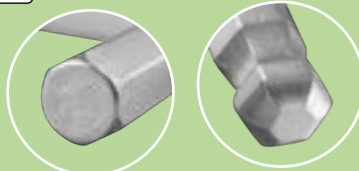

CrV





# CAIXA DE FERRAMENTAS DE 38 PEÇAS COM MINI ROQUETE DE 1/4"

**53156**

22,50€

0,48 6 36 1.008



**52198**

33,00€

0,45 6 36 1.800



CrV

1/4"

38  
PCS

## CONTÉM

		1/4"	x11	4, 4.5, 5, 6, 7, 8, 9, 10, 11, 12, 13mm
			x1	1/4"
			x2	PH3, PH4
			x2	PZ3, PZ4
			x5	4, 5, 6, 7, 8mm
		6mm	x3	SL6, SL8, SL10
			x2	T8, T9, T10, T15, T20, T25, T30, T40
			x4	M5, M6, M9, M10
			x1	1/4"

**53156**



**52198**



## JOGO DE PONTAS 1/2"

**52714**

15,50€

0,65 4 24 576



**52716**

15,50€

0,60 4 24 576



10, 11, 12, 13, 14, 15, 16, 17, 18, 19mm

1/2"

10  
PCS

APRESENTADA EM  
GUÍA METÁLICA



CrV



DESMANCHA  
DISPONÍVEL



DESMANCHA  
DISPONÍVEL

## JOGO DE PONTAS DE 1/4"

**52715**

10,00€

0,27 6 36 1.152



**52717**

11,00€

0,27 6 36 1.152



4, 4.5, 5, 5.5, 6, 7, 8, 9, 10, 11, 12, 13, 14mm

1/4"

13  
PCS



DESMANCHA  
DISPONÍVEL



DESMANCHA  
DISPONÍVEL

CrV

APRESENTADA EM  
GUÍA METÁLICA

## JOGO DE 18 PONTAS DE 1/4"

**52909**

12,50€

0,35 8 32 1.500



S-2 1/4"

18  
PCS



CrV

## JOGO DE 30 PONTAS DE 1/4"

**52908**

17,50€

0,60 8 32 500



S-2 1/4"

30  
PCS



CrV

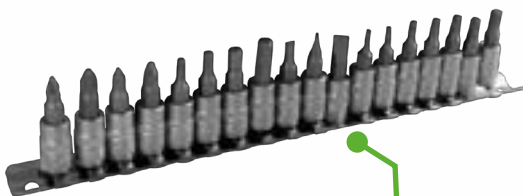

APRESENTADA EM  
GUÍA METÁLICA



APRESENTADA EM  
GUÍA METÁLICA

## CONTÉM

	x2	PH1, PH2
	x2	PZ1, PZ2
	x4	3, 4, 5, 6mm
	x3	SL4, SL5.5, SL6.5
	x7	T8, T10, T15, T20, T25, T27, T30

## CONTÉM

	x3	PH0, PH1, PH2
	x3	PZ0, PZ1, PZ2
	x4	SL4, SL5.5, SL6.5, SL7
	x8	T8, T9, T10, T15, T20, T25, T27, T30
	x8	T8, T9, T10, T15, T20, T25, T27, T30

## JOGO DE PONTAS TORX

3/8" - 1/2"

**53084**  
24,00€

0,70 5 20



3/8": T30, T40, T45, T50  
1/2": T55, T60, T70



1/2" 3/8" 7 PCS

CrV

## JOGO DE 7 PONTAS TORX INVIO LÁVEL 1/4"

TORX INVIO LÁVEL 1/4"

**53127**  
12,00€

0,10 100 1.000



T10, T15, T20, T25,  
T30, T40, T45



CrV 1/4" 7 PCS

CrV



APRESENTADA EM GUÍA METÁLICA



APRESENTADA EM GUÍA METÁLICA



## JOGO PONTAS TS 5 CARAS INVIO LÁVEL

**51746**  
12,00€

0,2 5 75



APRESENTADA EM GUÍA METÁLICA



TS10, TS15, TS20, TS25,  
TS30, TS40, TS45



CrV 1/4" 7 PCS



## JOGO DE PONTAS DE RIBE

**50980**  
22,00€

0,76 5 20 300



1/2" 1/2" 100mm:  
M12, M13, M14  
3/8" 3/8" 90mm:  
M6, M7, M8, M10



**50982**  
22,00€

0,46 10 40 300



3/8" 3/8" 100mm HB3:  
4, 5, 6, 7, 8, 10mm



**52320**  
22,00€

0,76 5 20 480



1/2" 1/2" 100mm:  
M12, M13, M14  
3/8" 3/8" 90mm:  
M6, M7, M8, M10



APRESENTADA EM GUÍA METÁLICA

## CHAVE PONTA XZN ESP. VAG

**12029**  
4,50€

0,17 5 50 1.500



INVIO LÁVEL  
M16X58MM



**12030**  
6,50€

0,25 25 50 1.500



INVIO LÁVEL  
M16X100MM



CrV 1/2"



## VARILHA EXTRA-LARGA DE 12 FACES DE 800mm de 1/2"

REF.	DESCRIÇÃO	0,58	10	20	1.750	€
52059	Ø 8mm - 800mm	0,58	10	20	1.750	29,00€
52060	Ø 10mm - 800mm	0,58	-	25	1.750	32,00€
53667	Ø 12mm - 800mm	0,80	10	20	-	32,00€
53668	Ø 14mm - 800mm	1,05	10	20	-	34,00€

800mm



CrV 1/2"





## JOGO DE CHAVES FIXAS ISOLADAS

53152

373,00€

4,70

3

72



CrV

20  
PCS

6, 7, 8, 9, 10, 11, 12, 13,  
14, 15, 16, 17, 18, 19, 21,  
22, 24, 27, 30, 32mm



## ESTOJO DE FERRAMENTAS ISOLADAS 20 PEÇAS DE 3/8"

53154

462,00€

3,3

3

72



CrV

3/8"

20  
PCS

### CONTÉM

	3/8"	x12	8, 10, 11, 12, 13, 14, 16, 17, 18, 19, 21, 22mm
	1/2"	x1	200mm
	1/2"	x2	125, 250mm
	3/8"	x1	200mm
	3/8"	x4 75mm	4, 5, 6, 8mm



## CONJUNTO DE 50 CHAVES ISOLADAS ATÉ 1.000V

52521

125,00€

1,43

6

240



CrV

50  
PCS



### CONTÉM

	x3	PH0, PH1, PH2		x5	H2,5, H3, H4, H5, H6		x3	M4x4,0, M5x5,0, M6x5,0		x1	89
	x7	SLO.4x2,0, SLO.4x2,5, SLO.5x3,0, SLO.6x3,5, SLO.8x4,0, SL1.0x5,5, SL1.2x6,5mm		x2	R1, R2		x4	4, 6, 8, 10mm		x1	89
	x3	PZ0, PZ1, PZ2		x4	1, 2, 3, 4		x2	R1, R2		Voltage Tester: 3,0 x 70 + Torx 31 x 105	
	x9	T6, T8, T9, T10, T15, T20, T25, T27, T30		x4	4, 6, 8, 10		x2	6,3 x 89, 8,1 x 89			

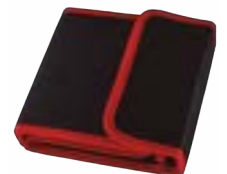

## CONJUNTO DE PONTAS E CHAVES ISOLADAS ATÉ 1000V

**52009**  
36,00€

0,34 10 50

- Optimizado para aplicações em trabalhos com electricidade.  
- Ferramentn de segurança.

CrV

### CONTÉM

x2 PH1x100, PH2x100  
x4 SL0.4x2.5x100, SL0.8x4.0x100, SL1.0x5.5x100, SL1.2x6.5x100mm



**AC 1000V**  
IEC 60900:2004

Cumpr com: DIN EN60900:2005-01 - EN60900:2004

## CONJUNTO DE 7 CHAVES ISOLADAS ATÉ 1.000V

**52519**  
25,50€

0,14 5 30 840

CrV

### CONTÉM

x2 PH00x50, PH0x50mm  
x5 SL1.5x0.23x50, SL1.8x0.30x50, SL2.0x0.40x50, SL2.5x0.40x50, SL3.0x0.50x50mm

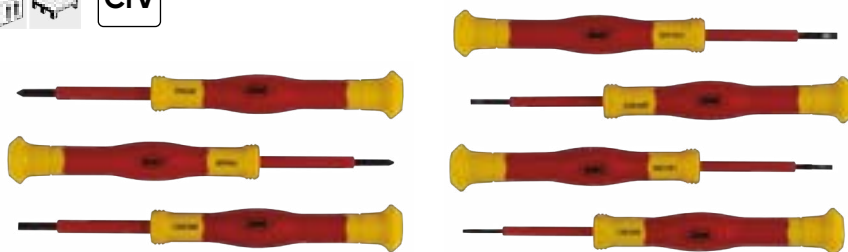

**AC 1000V**  
IEC 60900:2004

## CHAVE DE FENDA EVA - ACABAMENTO DE CARBONO

**15162**  
25,50€

0,50 10 220

x4 0.5x3.0x75, 0.8x4.0x100, 1.0x5.5x125, 1.2x6.5x150mm  
x3 PH0x75, PH1x80, PH2x100mm

VDE

8  
PCS

### DESMANCHA DISPONÍVEL

REF.	Ø				€
15227	0.5x3.0x75mm	0,02	10	50	3,50€
15228	0.8x4.0x100mm	0,05	10	50	4,00€
15229	1.0x5.5x125mm	0,08	5	50	5,00€
15230	1.2x6.5x150mm	0,11	5	50	5,00€
15231	PH0x75mm	0,02	10	50	3,50€
15232	PH1x80mm	0,05	10	50	4,00€
15233	PH2x100mm	0,08	5	50	5,00€
15234	Tester Circuito Automotivo 140mm	0,02	10	50	3,00€



## FACA ISOLADA

RETA

**53164**  
15,00€

0,10 6 36

CURVADA

**53165**  
17,50€

0,10 6 36

180mm  
50mm

CrV

**1000V<sup>C</sup>**  
IEC 60900

Certificate  
EN60900





CHAVES



36

FERRAMENTAS EM POLEGADA



43

CHAVES DE FENDA



44

FERRAMENTAS DE MEDIÇÃO



46

CADEDADOS



47

MARTELO



48

SERRAS



49

PUNÇÕES



50

REBITADORAS



51

ROQUETES



52

BARRAS DE EXTENSÃO



56

CORTA TUBOS



58

PELACALBLES



59

ALICATES



60

CHAVES DE GANCHO / PARA CORTAR  
PORCÁS / INGLESA



65

CHAVE DE CANOS



66

GARAMPOS DE FIXAÇÃO



66

CORTADORES PARAFUSO



66



# FERRAMENTAS MANUAIS



**SERIE261**

# JOGO DE CHAVES ARTICULADAS DE BOCA-LUNETA COM ROQUETE



- Cabeça articulada de 0° a 180°.  
- Roquete de 72 dentes com 5° de arco.

CROMADO



12 CHAVES

7 CHAVES

**51318**  
89,00€

8, 9, 10, 11, 12, 13, 14, 15, 16, 17, 18, 19mm

12 PCS

Kg	2,15
Box	5
Box	10
Box	200



**53017**  
52,00€

8, 10, 11, 13, 14, 17, 19mm

7 PCS

Kg	1,18
Box	5
Box	10
Box	320



DESMANCHA DISPONÍVEL

REF.	mm	Kg	Box	Box	€	REF.	mm	Kg	Box	Box	€	REF.	mm	Kg	Box	Box	€	REF.	mm	Kg	Box	Box	€
10552	8mm	0,06	10		7,10€	10555	11mm	0,09	10		7,80€	10558	14mm	0,15	10		9,35€	10561	17mm	0,22	10		10,95€
10553	9mm	0,07	10		7,35€	10556	12mm	0,11	10		8,10€	10559	15mm	0,16	10		9,50€	10562	18mm	0,26	5		12,30€
10554	10mm	0,09	10		7,50€	10557	13mm	0,13	10		8,10€	10560	16mm	0,19	10		10,60€	10563	19mm	0,28	10		12,45€

## JOGO DE 6 CHAVES COM ROQUETE

**53021**  
44,00€

0,86 5 20 1.500

8x9, 10x11, 12x13, 14x15, 16x18, 17x19mm

CROMADO



6 PCS

DESMANCHA DISPONÍVEL

REF.	mm	Kg	Box	Box	€
13485	8x9mm	0,06	10		7,60€
13486	10x11mm	0,09	10		8,35€
13487	12x13mm	0,12	10		9,40€
13488	14x15mm	0,15	10		11,05€
13489	16x18mm	0,2	10		12,65€
13490	17x19mm	0,25	10		13,60€



## JOGO DE 7 CHAVES COM ROQUETE EXTRA LONGO

**54066**  
78,50€

2,33 5 175

**53019**  
78,00€

2,33 5 175

CROMADO



7 PCS

MÓDULO COM ACABAMENTO EM FIBRA DE CARBONO

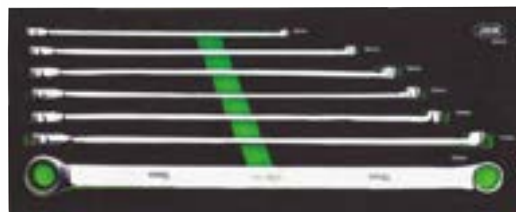

DESMANCHA DISPONÍVEL



REF.	mm	Kg	Box	Box	€
13453	8mm	0,1	6		9,00€
13454	10mm	0,15	6		9,50€
13455	12mm	0,21	6		10,50€
13456	13mm	0,23	6		11,50€
13457	14mm	0,28	6		12,00€
13460	17mm	0,44	6		15,00€
13462	19mm	0,53	6		17,00€

8mm (23,5mmL)  
10mm (29,3mmL)  
12mm (32,8mmL)  
13mm (34,9mmL)  
14mm (36,7mmL)  
17mm (41mmL)  
19mm (42mmL)

## JOGO DE 8 CHAVES DE BOCA-LUNETA COM ROQUETE PEQUENAS

**53022**  
46,00€

0,82 5 20 1.500

CROMADO



DESMANCHA DISPONÍVEL

REF.	mm	Kg	Box	Box	€
13491	10mm	0,05	10		5,30€
13492	11mm	0,06	10		5,35€
13493	12mm	0,07	10		5,50€
13494	13mm	0,08	10		6,00€
13495	14mm	0,09	10		6,40€
13496	15mm	0,12	10		6,60€
13497	17mm	0,14	10		7,50€
13498	19mm	0,19	10		8,50€



10, 11, 12, 13, 14, 15, 17, 19mm

8 PCS





## SET 22 CHAVES BOCA-LUNETA COM ROQUETE

54041

8,5

2

198,00€



6, 7, 8, 9, 10, 11, 12, 13, 14, 15, 16, 17, 18, 19, 20, 21, 22, 23, 24, 27, 30, 32mm

22  
PCS



90

### DESMANCHA DISPONÍVEL

REF.	mm			€	REF.	mm			€
15352	6mm	0,03	10	6,00€	15363	17mm	0,19	10	9,00€
15353	7mm	0,04	10	6,00€	15364	18mm	0,22	10	9,00€
15354	8mm	0,05	10	6,00€	15365	19mm	0,22	10	10,00€
15355	9mm	0,06	10	6,00€	15366	20mm	0,23	10	10,50€
15356	10mm	0,1	10	6,00€	15367	21mm	0,37	10	11,50€
15357	11mm	0,08	10	6,50€	15368	22mm	0,37	10	12,50€
15358	12mm	0,09	10	6,50€	15369	23mm	0,37	10	13,00€
15359	13mm	0,1	10	7,00€	15370	24mm	0,53	10	13,50€
15360	14mm	0,11	10	7,50€	15371	27mm	0,74	10	20,00€
15361	15mm	0,13	10	8,00€	15372	30mm	0,89	10	23,00€
15362	16mm	0,15	10	8,50€	15373	32mm	1,12	10	29,00€



## CONJUNTO DE 12 CHAVES COMBINADAS DE CHARNEIRA CURTAS DE CATRACA

54032

1,33

5

20

79,00€



8, 9, 10, 11, 12, 13, 14, 15, 16, 17, 18, 19mm

12  
PCS

### DESMANCHA DISPONÍVEL

REF.	mm			€	REF.	mm			€
15328	8mm	0,11	6	6,00€	15334	14mm	0,11	6	7,00€
15329	9mm	0,17	6	5,50€	15335	15mm	0,17	6	7,50€
15330	10mm	0,22	6	5,50€	15336	16mm	0,22	6	8,00€
15331	11mm	0,31	6	5,50€	15337	17mm	0,31	6	8,50€
15332	12mm	0,45	6	6,00€	15338	18mm	0,45	6	9,00€
15333	13mm	0,47	6	6,50€	15339	19mm	0,47	6	9,50€



## SET 22 CHAVES BOCA-LUNETA COM ROQUETE

53020

7,38

2

54

199,00€



22  
PCS

### CROMADO

6, 7, 8, 9, 10, 11, 12, 13, 14, 15, 16, 17, 18, 19, 20, 21, 22, 23, 24, 27, 30, 32mm



## SET 12 CHAVES BOCA-LUNETA COM ROQUETE

53871

1,60

2

6

288

59,90€



12  
PCS

### CROMADO

8, 9, 10, 11, 12, 13, 14, 15, 16, 17, 18, 19mm



### DESMANCHA DISPONÍVEL REF.53020,53871,15122

REF.	mm			€	REF.	mm			€
13463	6mm	0,03	10	5,30€	13474	17mm	0,19	10	8,70€
13464	7mm	0,04	10	5,30€	13475	18mm	0,22	10	9,10€
13465	8mm	0,05	10	5,55€	13476	19mm	0,22	10	9,60€
13466	9mm	0,06	10	5,55€	13477	20mm	0,23	10	9,85€
13467	10mm	0,1	10	6,00€	13478	21mm	0,37	10	12,20€
13468	11mm	0,08	10	6,25€	13479	22mm	0,37	10	13,10€
13469	12mm	0,09	10	6,25€	13480	23mm	0,37	10	15,45€
13470	13mm	0,1	10	6,60€	13481	24mm	0,53	10	15,75€
13471	14mm	0,11	10	6,90€	13482	27mm	0,74	10	22,10€
13472	15mm	0,13	10	7,25€	13483	30mm	0,89	10	25,45€
13473	16mm	0,15	10	8,10€	13484	32mm	1,12	10	27,15€

## MÓDULO DE CARBONO EVA DE 12 CHAVES COMBINADAS COM ROQUETE

15122

1,70

10

220

69,00€



12  
PCS

### CROMADO

8, 9, 10, 11, 12, 13, 14, 15, 16, 17, 18, 19mm

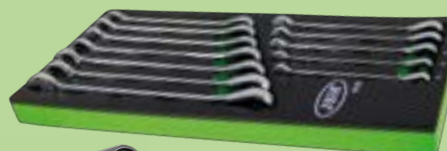

## JOGO DE 6 CHAVES ARTICULADAS COM ROQUETE

53018

2,66 5 125  
136,00€



6  
PCS

8x9,10x11, 12x13,  
14x15, 16x18,  
17x19mm

CROMADO



DESMANCHA DISPONÍVEL

REF.	mm			€
13447	8x9mm	0,11	6	16,50€
13448	10x11mm	0,17	6	17,50€
13449	12x13mm	0,22	6	20,00€
13450	14x15mm	0,31	6	23,00€
13451	16x18mm	0,45	6	28,00€
13452	17x19mm	0,47	6	29,50€



## CONJUNTO DE 12 CHAVES COMBINADAS DE CHARNEIRA CURTAS DE CATRACA

15158

1,05 10 220  
50,00€

8, 10, 11, 13,  
14, 17, 19mm



7  
PCS

CROMADO

DESMANCHA DISPONÍVEL

REF.	mm				€
15216	8mm	0,05	10	50	6,75€
15217	10mm	0,08	10	50	7,20€
15218	11mm	0,08	10	50	7,65€
15219	13mm	0,11	10	50	8,10€
15220	14mm	0,15	10	50	9,05€
15221	17mm	0,21	10	50	10,85€
15222	19mm	0,26	10	50	11,75€



## KIT DE 3 CHAVES TIPO 4 EM 1

15316

0,73 10 220  
50,00€

8-9-10-11-12-13-  
14-15-16-17-18-  
19mm

3  
PCS

CROMADO

DESMANCHA DISPONÍVEL

REF.	mm		€
15515	12-13mm x 8-10mm	0,13	15,50€
15516	14-15mm x 9-11mm	0,18	19,00€
15517	18-19mm x 16-17mm	0,37	22,50€



## JOGO DE 4 CHAVES TORX COM ROQUETE ARTICULADAS

50754

0,82 20 360  
59,00€



4  
PCS

CROMADO

- Cabeça Articulada de 0° a 180°.
- Roquete de 72 dentes com 5° de Arco.

E6 x E8  
E10 x E12  
E14 x E18  
E20 x E24



DESMANCHA DISPONÍVEL

REF.			€	
10527	E6xE8	0,09	10	13,05€
10528	E10xE12	0,12	10	15,80€
10529	E14xE18	0,22	10	18,00€
10530	E20xE24	0,37	10	28,65€



## CAIXA FERRAMENTAS DE 6 CHAVES 12 FACES ARTICULADAS

51659

1,60 10 230  
59,00€



6  
PCS

8x9, 10x11, 12x13,  
14x15, 16x17,  
18x19mm

CROMADO



DESMANCHA DISPONÍVEL

REF.	Ø		€	
10621	XZN 8-9	0,09	-	9,50€
10622	XZN 10-11	0,13	-	10,00€
10623	XZN 12-13	0,16	5	12,60€
10624	XZN 14-15	0,20	-	13,50€
10625	XZN 16-17	0,29	-	15,65€
10626	XZN 18-19	0,37	-	17,75€



## CAIXA DE FERRAMENTAS 4 CHAVES ARTICULADAS TORX

50622

1,07 10 320  
48,50€

CROMADO



4  
PCS

E6xE8, E10xE12,  
E14xE18, E20xE24

DESMANCHA DISPONÍVEL

REF.	Ø		€
10617	E6xE8	0,07	14,05€
10618	E10xE12	0,11	15,10€
10619	E14xE18	0,20	15,65€
10620	E20xE24	0,34	16,15€





## BANDEJA DE EVA COM REVESTIMENTO CARBONO COM 6 CONJUNTOS CHAVES PORCA, TIPO S

15160

0,73 10 220

39,00€

8x9, 10x11, 12x13, 14x15, 16x17, 18x19mm

6 PCS

CROMADO

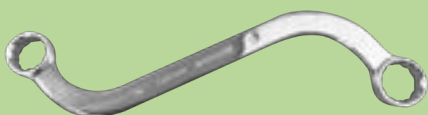

DESMANCHA DISPONÍVEL

REF.	mm	kg	box	set	€
15196	8x9mm	0,04	10	50	5,00€
15197	10x11mm	0,06	10	50	5,50€
15198	12x13mm	0,09	10	50	6,50€
15199	14x15mm	0,13	10	50	7,50€
15200	16x17mm	0,16	5	50	9,50€
15201	18x19mm	0,18	5	50	9,50€

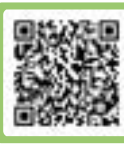

## 4 PÇS. CONJUNTO COMBINADO DE CHAVES REVESTIDAS DE CARBONO, BANDEJA DE EVA

15161

1,55 10 220

56,00€

27, 29, 30, 32mm

4 PCS

CROMADO

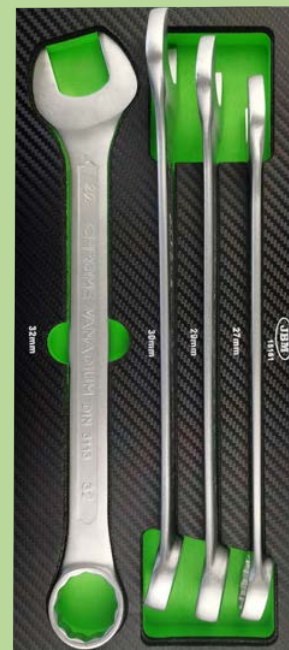

DESMANCHA DISPONÍVEL

REF.	mm	kg	box	set	€
15223	27mm	0,36	5	50	14,00€
15224	29mm	0,42	5	50	15,00€
15225	30mm	0,47	5	50	15,50€
15226	32mm	0,57	5	50	17,50€



## JOGO DE 8 CHAVES PEQUENAS BOCA-LUNETA

50564

0,65 5 20 400

30,00€

8 PCS

10, 11, 12, 13, 14, 15, 17, 19mm

CROMADO

DESMANCHA DISPONÍVEL

REF.	mm	kg	box	set	€
10564	10	0,05	10	100	2,50€
10565	11	0,05	10	100	3,50€
10566	12	0,05	10	100	3,50€
10567	13	0,05	10	100	3,50€
10568	14	0,06	10	100	4,00€
10569	15	0,05	10	100	4,50€
10570	16	0,10	10	100	4,50€
10571	17	0,15	10	100	5,00€



## JOGO DE CHAVES BOCA-LUNETA

14 CHAVES

7 CHAVES

50560

52970

35,00€

37,00€

14 PCS

6, 7, 8, 9, 10, 11, 12, 13, 14, 15, 16, 17, 18, 19mm

kg	1,25
box	5
set	20
set	240

kg	1,30
box	5
set	20
set	384

CINCADO

CROMADO



DESMANCHA DISPONÍVEL

CINCADO	mm	kg	box	set	€
10548	6mm	0,03	10	100	1,75€
10549	7mm	0,03	10	100	2,00€
10550	8mm	0,04	10	100	2,15€
10551	9mm	0,05	10	100	2,15€
10531	10mm	0,05	10	100	3,00€
10532	11mm	0,05	10	100	2,70€
10533	12mm	0,07	10	100	3,00€
10534	13mm	0,08	10	100	3,25€
10535	14mm	0,10	10	100	3,50€
10536	15mm	0,10	10	100	3,65€

50560



CINCADO	mm	kg	box	set	€
10537	16mm	0,11	10	100	3,90€
10538	17mm	0,14	10	100	4,30€
10539	18mm	0,16	10	100	4,75€
10540	19mm	0,20	10	60	5,25€

7 PCS

20, 21, 22, 24, 27, 30, 32mm

CINCADO

50896

47,50€

kg	3
box	5
set	10
set	216



CROMADO

52971

52,50€

kg	2,55
box	10
set	224

DESMANCHA DISPONÍVEL

CINCADO	mm	kg	box	set	€
10541	20mm	0,03	6	60	5,55€
10542	21mm	0,03	6	60	5,85€
10543	22mm	0,04	6	60	7,00€
10544	24mm	0,05	6	48	8,10€
10545	27mm	0,05	6	24	9,75€
10546	30mm	0,05	6	24	11,55€
10547	32mm	0,07	6	24	13,45€

50896



## JOGO DE CHAVES FIXAS

12 CHAVES

7 CHAVES

**12 PCS**  
6x7, 8x9, 10x11, 12x13, 14x15, 16x17, 18x19, 20x22, 21x23, 24x27, 25x28, 30x32mm

**7 PCS**  
6x7, 8x9, 10x11, 12x13, 14x15, 16x17, 18x19mm

**51529**  
53,00€

**52973**  
57,00€

**2,63**  
**5**  
**165**  
CINCADO

**2,50**  
**5**  
**192**  
CROMADO



**50561**  
18,00€

**52974**  
16,00€

**0,69**  
**5**  
**20**  
**320**  
CINCADO

**0,7**  
**5**  
**20**  
**440**  
CROMADO



51529



50561



DESMANCHA DISPONÍVEL

CINCADO	mm	kg	mm	mm	€
10589	6x7	0,03	10	100	2,00€
10590	8x9	0,03	10	100	2,40€
10579	10x11	0,06	5	100	3,00€

CINCADO	mm	kg	mm	mm	€
10580	12x13	0,07	10	100	3,10€
10581	14x15	0,10	10	100	3,40€
10582	16x17	0,14	10	100	4,00€

CINCADO	mm	kg	mm	mm	€
10583	18x19	0,19	10	100	4,15 €
10584	20x22	0,25	-	100	5,05 €
10585	21x23	0,31	-	50	6,75 €

CINCADO	mm	kg	mm	mm	€
10586	24x27	0,35	-	50	7,60 €
10587	25x28	0,36	-	50	9,80 €
10588	30x32	0,54	-	25	10,50 €

## JOGO DE CHAVES FIXAS CURVADAS

12 CHAVES

7 CHAVES

**12 PCS**  
6x7, 8x9, 10x11, 12x13, 14x15, 16x17, 18x19, 20x22, 21x23, 24x27, 25x28, 30x32mm

**7 PCS**  
6x7, 8x9, 10x11, 12x13, 14x15, 16x17, 18x19mm

CINCADO  
**50889**  
64,50€

CROMADO  
**52975**  
66,50€

CINCADO  
**50562**  
20,00€

CROMADO  
**52976**  
22,00€



50889



50562



DESMANCHA DISPONÍVEL

CINCADO	mm	kg	mm	mm	€
10627	6x7	0,04	10	100	2,80€
10628	8x9	0,06	10	100	3,10€
10629	10x11	0,08	10	100	3,65€

CINCADO	mm	kg	mm	mm	€
10630	12x13	0,11	10	100	3,90€
10631	14x15	0,14	10	100	4,20€
10632	16x17	0,18	10	100	5,30€

CINCADO	mm	kg	mm	mm	€
10633	18x19	0,22	10	100	6,60€
10634	20x22	0,43	-	50	7,80€
10635	21x23	0,30	-	50	8,15€

CINCADO	mm	kg	mm	mm	€
10636	24x27	0,35	-	25	8,80€
10637	25x28	0,48	-	25	12,05€
10638	30x32	0,73	-	-	12,65€

## 4 PÇS. CHAVE DUPLA FACE DE EXTREMIDADE FECHADA BANDEJA DE EVA REVESTIDA DE CARBONO

**15156**  
58,00€

CROMADO

DESMANCHA DISPONÍVEL

REF.	mm	kg	mm	mm	€
15206	21x23	0,36	5	50	15,00€
15207	24x27	0,38	5	50	16,50€
15208	25x28	0,43	5	50	17,00€
15209	30x32	0,58	10	50	18,00€



**4 PCS**

21x23, 24x27, 25x28, 30x32mm



## JOGO DE 8 CHAVES TIPO "C" CABEÇAL REDONDO 12 FACES

**52451** 0,93 5 20 300  
**38,50€**

CROMADO



6x7, 8x9, 10x11, 12x13,  
14x15, 16x17, 18x19,  
20x22mm



## JOGO DE 4 CHAVES TORX FIXAS EM SACO DE PANO

**51747**  
**21,00€**



6x8, 10x12,  
14x18, 20x24mm

CROMADO

0,38  
50  
500



### DESMANCHA DISPONÍVEL

REF.	mm	kg	box	box	€
11646	20x22	0,22	-	-	9,45€
11645	18x19	0,15	-	-	7,00€
11644	16x17	0,10	10	100	7,00€
11643	14x15	0,09	-	-	6,00€
11642	12x13	0,06	10	100	5,00€
11641	10x11	0,04	-	-	5,00€
11640	8x9	0,04	-	-	4,50€
11639	6x7	0,61	10	100	4,00€

## 11 PÇS. CHAVE TIPO L REVESTIDA DE CARBONO, BANDEJA DE EVA

**15159** 0,69 10 220  
**39,00€**

CROMADO

**5**  
PCS

8x10, 11x13, 14x15,  
17x19, 20x22mm

### DESMANCHA DISPONÍVEL

REF.	mm	kg	box	box	€
15191	8x10	0,05	10	50	7,00€
15192	11x13	0,07	10	50	8,00€
15193	14x15	0,10	-	-	8,50€
15194	17x19	0,15	5	50	10,50€
15195	20x22	0,23	-	-	12,50€



## JOGO CHAVES FIXAS 12 FACES

**51878** 1 5 10 240  
**48,00€**

CINCADO

6x7, 8x9, 10x11, 12x13, 14x15,  
16x17, 18x19, 20x22mm

**8**  
PCS



### DESMANCHA DISPONÍVEL

REF.	Ø	kg	€
11250	XZN 6x7	0,04	5,50€
11251	XZN 8x9	0,04	7,90€
11252	XZN 10x11	0,07	9,00€
11253	XZN 12x13	0,07	9,50€
11254	XZN 14x15	0,09	9,45€
11255	XZN 16x17	0,12	10,85€
11256	XZN 18x19	0,16	11,80€
11257	XZN 20x22	0,23	13,25€

## JOGO CHAVES FIXAS COM BOCA ABERTA DE 6 FACES

**51879** 0,74 5 20 480  
**38,50€**

CINCADO

10x11, 12x13, 14x15,  
16x17, 18x19

**8**  
PCS

### DESMANCHA DISPONÍVEL

REF.	Ø	kg	€
11258	HEX 10x11	0,08	7,30€
11259	HEX 12x13	0,11	8,30€
11260	HEX 14x15	0,11	9,75€
11261	HEX 16x17	0,18	11,35€
11262	HEX 18x19	0,21	13,50€



## 11 PÇS. CHAVE TIPO L REVESTIDA DE CARBONO, BANDEJA DE EVA

**15157** 0,81 10 220  
**42,00€**

CROMADO

**6**  
PCS

6x8, 10x12, 13x14,  
15x17, 19x21,  
22x24mm

### DESMANCHA DISPONÍVEL

REF.	mm	kg	box	box	€
15210	6x8	0,05	10	50	5,00€
15211	10x12	0,07	10	50	5,50€
15212	13x14	0,09	10	50	6,50€
15213	15x17	0,13	10	50	7,00€
15214	19x21	0,16	5	50	9,00€
15215	22x24	0,23	5	50	10,50€



## JOGOS 6 CHAVES EXTRA-LARGAS

**51864**

**64,00€**

1,87 10 250

10x11mm (290mmL),  
12x14mm (330mmL),  
13x15mm (368mmL),  
16x18mm (407mmL),  
17x19mm (407mmL),  
22x24mm (430mmL)



**52912**

**78,50€**

1,62 10 220



E6xE7 (200mmL),  
E8xE10 (235mmL),  
E11xE12 (290mmL),  
E14xE16 (370mmL),  
E18xE20 (410mmL),  
E22xE24 (420mmL)



**6**  
PCS

**CROMADO**

**DESMANCHA DISPONÍVEL**

REF.	Ø	kg	pcs	€
11244	XL XZN 10x11	0,13	5	8,50€
11245	XL XZN 12x14	0,18	-	9,15€
11246	XL XZN 13x15	0,21	5	12,35€
11247	XL XZN 16x18	0,30	-	14,00€
11248	XL XZN 17x19	0,31	5	14,55€
11249	XL XZN 22x24	0,43	5	26,50€



## 14 CHAVES DE DUAS BOCA EM FORMA DE "L"

**51528**

**43,00€**

3,55 5 280

8, 9, 10, 11, 12, 13, 14, 15,  
16, 17, 18, 19, 20, 21mm



**14**  
PCS

**CINCADO**



**DESMANCHA DISPONÍVEL**

REF.	mm	kg	€
10603	8	0,07	2,10€
10604	9	0,08	2,25€
10591	10	0,09	2,50€
10592	11	0,12	2,55€
10593	12	0,16	3,15€
10594	13	0,17	3,20€
10595	14	0,20	3,35€
10596	15	0,25	4,25€
10597	16	0,30	4,50€

REF.	mm	kg	€
10598	17	0,32	4,60€
10599	18	0,43	6,00€
10600	19	0,41	6,25€
10601	20	0,45	6,50€
10602	21	0,47	7,05€



## 11 PCS. CHAVE TIPO L REVESTIDA DE CARBONO, BANDEJA DE EVA

**15155**

**56,00€**

2,03 10 220



**11**  
PCS

8, 10, 11, 12, 13, 14,  
15, 16, 17, 18, 19mm

**DESMANCHA DISPONÍVEL**

REF.	mm	kg	pcs	€
15006	8	0,05	10	3,50€
15020	9	0,09	10	4,00€
15182	10	0,12	10	4,50€
15183	11	0,12	10	5,00€
15184	12	0,16	10	5,50€
15185	13	0,19	5	6,00€

REF.	mm	kg	pcs	€
15186	17	0,21	5	6,50€
15187	18	0,24	5	6,50€
15188	19	0,26	5	7,00€
15189	20	0,28	5	8,50€
15190	21	0,31	5	9,00€



## KIT DE 8 CHAVES DE TUBO

**53420**

**68,00€**

1,50 20 540

6x7, 8x9, 10x11, 12x13, 14x15,  
16x17, 18x19, 20x22mm

**8**  
PCS

**CINCADO**





## JOGO DE 8 CHAVES EN "T" CABEÇA REDONDA

**53979** 0,42 10 40  
30,50€



T10x75,  
T15x75,  
T20x100,  
T25x100,  
T30x150,  
T40x150,  
T45x200,  
T50x200mm

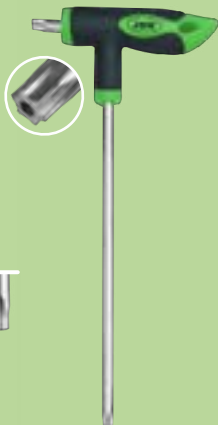

## JOGO DE 8 CHAVES EN "T" CABEÇA REDONDA

**53980**  
30,50€



H2x100  
H2.5x100  
H3x100  
H4x150  
H5x150  
H6x200  
H8x200  
H10x200



## CONJUNTO DE 9 BOCAIS



### EXTRA LONGOS

**53737**  
12,50€

90-218mm



0,42 10 40



### LONGOS

**53739**  
10,50€

86-150mm



0,32 10 40



### CURTOS

**53955**  
10,00€

72-170mm



0,25 10 40 1.480

T10, T15, T20,  
T25, T27, T30,  
T40, T45, T50

53737/53739/53955



### EXTRA LONGOS

**53738**  
11,50€

90-220mm



9  
PCS

0,45 10 40



### LONGOS

**53740**  
10,00€

72-170mm



0,37 10 40

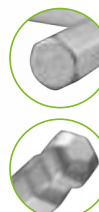

### CURTOS

**53954**  
9,50€

43-97mm



0,25 10 40 1.480

2, 2.5, 3, 4, 5,  
5.5, 6, 8, 10mm

53738/53740/53954

## FERRAMENTAS EM POLEGADA

### JOGO DE 17 CHAVES DE BOCAS LUNETA EM POLEGADA

**51890**  
78,00€

3,92 4 192

**52972**  
79,00€

4,60 4

17  
PCS

#### CINCADO

5/16", 3/8", 7/16", 1/2", 9/16",  
19/32", 5/8", 11/16", 3/4", 13/16",  
7/8", 15/16", 1", 1-1/16", 1-1/8",  
1-3/16", 1-1/4"

#### CROMADO



### JOGO DE 9 CHAVES UMBRAKO EM POLEGADA

**54005**  
14,00€

0,37 10 40 1.120

9  
PCS

CrV

1/16", 5/64", 3/32", 1/8",  
5/32", 3/16", 1/4", 5/16",  
3/8"

72-170mm

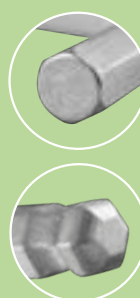

## KIT DE 208 BITS

53574

2,29 6 216

43,50€

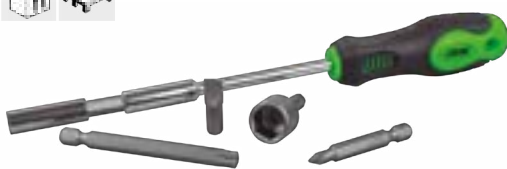

208  
PCS

CrV

### CONTÉM

25mmL	x12	1,5, 2, 2,5, 3, 3,5, 4, 4,5, 5, 5,5, 6, 7, 8mm	25mmL	x4	4, 6, 8, 10mm
50mmL	x5	1/16, 5/64, 3/32, 7/64, 1/8, 9/64, 5/32, 3/16, 7/32, 1/4	50mmL	x4	4, 6, 8, 10mm
75mmL	x5	2,5, 3, 4, 5, 6mm	25mmL	x4	1, 2, 3, 4mm
25mmL	x18	PH00, PH0, PH1(x5), PH2(x5), PH3(x5), PH4	50mmL	x4	1, 2, 3, 4mm
50mmL	x3	PH1, PH2, PH3	25mmL	x6	2, 2,5, 3, 4, 5, 6mm
75mmL	x3	PH1, PH2, PH3	25mmL	x6	5/64, 3/32, 7/64, 1/8, 9/64, 5/32
25mmL	x17	PZ00, PZ0, PZ1(x5), PZ2(x5), PZ3(x4), PZ4	25mmL	x13	1,5, 6, 7, 8, 9, 10, 15, 20, 25, 27, 30, 40, 45
50mmL	x3	PZ1, PZ2, PZ3	25mmL	x3	1, 2, 3mm
75mmL	x3	PZ1, PZ2, PZ3	25mmL	x4	0, 1, 2, 3mm
25mmL	x14	T5, T6, T7, T8, T9, T10, T15, T20, T25, T27, T30, T35, T40, T45	25mmL	x3	M5, M6, M8
50mmL	x7	T10, T15, T20, T25, T27, T30, T40	25mmL	x9	TS10, TS15, TS20, TS25, TS27, TS30, TS40, TS45, TS50
75mmL	x7	T10, T15, T20, T25, T27, T30, T40	25mmL	x12	SL2, SL2,5, SL3, SL3,5, SL4, SL4,5, SL5, SL5,5, SL6, SL6,5, SL7, SL8
25mmL	x3	6, 8, 10mm			
50mmL	x3	6, 8, 10mm			

mm	x10	4, 5, 6, 7, 8, 9, 10, 11, 12, 13
x10		5/32, 3/16, 7/32, 1/4, 9/32, 5/16, 3/8, 7/16, 1/2
6mm	x1	1/4"
x1		

## JOGO DE CHAVES - CURTAS E LONGAS

52500

0,33 60 720

16,50€



8  
PCS



### CURTAS

x3	x5
PH00x25, PH0x25, PH1x25	SL0,4x2x25, SL0,4x2,5x25, SL0,5x3x25, SL0,5x3,5x25, SL0,8x4x25

53917

0,2 5 50

8,00€



7  
PCS



### LONGAS

x3	x5
PH00, PH0, PH1	SL1,4, SL2,0, SL2,4, SL3,0

## ESTOJO DE DESTORNILLADORES COM CABO INTERCAMBIÁVEL 20 EM 1

53010

0,72 5 20 600

16,50€



11  
PCS



PUNHO  
ERGONÓMICO

### CONTÉM

x2	PH1, PH2
x2	4x6, 5x7mm
x3	T10x15, T20x25, T30x40
x3	H4x4mm, cabeça redonda H5x5mm, cabeça redonda H6x6mm, cabeça redonda

## CHAVE 6 EM 1

52072

0,19 12 72 1.728

5,00€



1



4  
PCS

CrV

### CONTÉM

x2	PH1, PH2
x2	5, 6mm
x2	8, 9mm

## CHAVE COM MULTIFUNÇÃO ESTRELA E FENDA

54060

0,11 24 1.056

4,50€

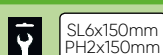

SL6x150mm  
PH2x150mm



54061

0,11 24 1.056

4,50€

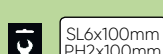

SL6x100mm  
PH2x100mm



51955

0,11 24 96 1.344

5,00€

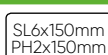

SL6x150mm  
PH2x150mm



52068

0,11 24 96 1.056

4,50€

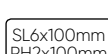

SL6x100mm  
PH2x100mm



EM EXPOSITOR  
DE 24 UDS



## CONJUNTO DE FERRAMENTAS PARA AJUSTAR FARÓIS

53729

18,00€

0,40 10 40

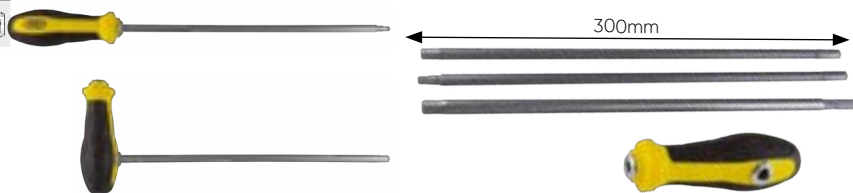

300mm H6, H7, T25

## JOGO DE 3 CHAVES ESTRELA

51952

13,30€

0,45 4 48 960

3 PCS

PH2x100, PH2x150, PH2x200mm

51953

13,30€

0,44 4 48 960

SL6x100, SL6x150, SL6x200mm

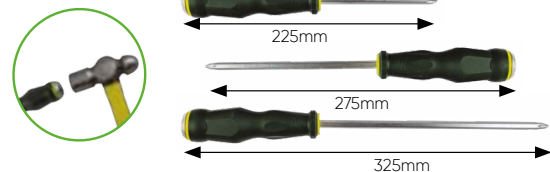

## JOGO DE 4 CHAVES DE FENDA DE IMPACTO

50902

13,00€

0,65 6 24 600

3", 4", 6", 8"

4 PCS



## CHAVE DE IMPACTO DE 1/2"

53694

17,00€

1 6 24

CrV 1/2" 8 PCS

CONTÉM

1/2" x1 8mm 1/2" x1  
 x3 PH 2x36mm, 3x36mm, 3x70mm  
 x3 SL 7x36mm, 8x36mm, 8x70mm



## JOGO DE 12 CHAVES DE FENDA DE IMPACTO

52748

43,50€

2,05 4 112

12 PCS



CABO ERGONÓMICO



CONTÉM

x6 PH2x38, PH1x75, PH3x150, PH0x75, PH2x100, PH4x200  
 x6 SL6x38, SL5x75, SL8x150, SL3,2x75, SL6x100, SL9,5x200mm

## CHAVE DE FENDA EVA - ACABAMENTO DE CARBONO

53943

18,50€

0,80 10 220

53944

18,50€

0,80 10 220

53945

18,50€

0,60 10 220

x7 PH4x200, PH3x150, PH2x100, PH2x38, PH1x80, PH0x120, PH1x100

x7 SL9x200, SL4x125, SL5x100, SL5x80, SL6x38, SL6x100, SL8x150mm

x7 T8x75, T9x75, T10x75, T15x75, T20x75, T25x100, T27x100

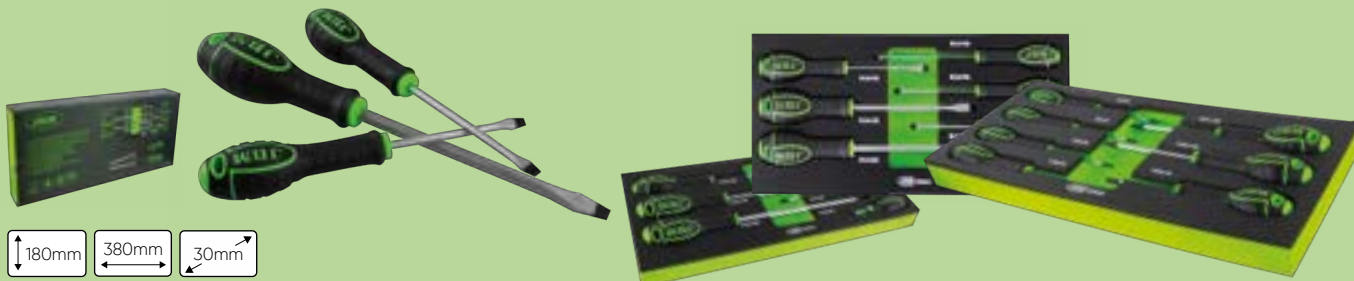

180mm 380mm 30mm

## CHAVE FLEXÍVEL

**52170**  
15,50€

0,27 12 48 672

1/4" 7 PCS

4, 5, 6, 7, 8, 10mm



## CHAVE FLEXÍVEL

**53575**  
14,00€

0,40 10 40 480

1/4" 4 PCS

4, 5, 7mm

CrV

500mm



## JOGO DE 3 CHAVES FLEXÍVEIS

**52169**  
25,00€

0,44 12 48 672

3 PCS

6, 7, 8mm



## NÍVEL

DE ALUMÍNIO

ISO90001:2008 RoHS CE

**53613**  
17,00€

0,55 5 30 500mm

**53614**  
19,50€

0,60 5 30 600mm

**53615**  
30,50€

0,85 5 20 800mm



EXPOSITOR PARA NIVELES

**14183** 0,80 10  
31,00€

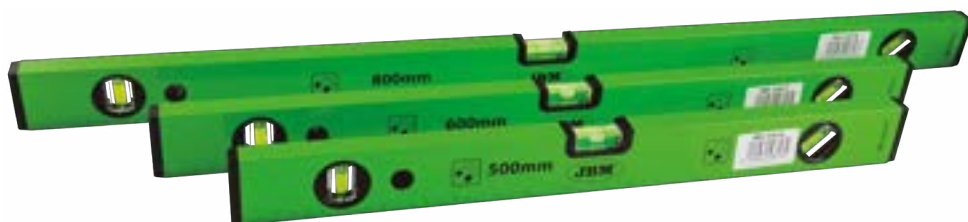

TUBULAR MAGNETIZADO

**53616**  
7,50€

0,30 5 60 500mm

**53617**  
8,50€

0,30 5 60 600mm

**53618**  
10,50€

0,35 5 30 800mm





## CINTA MÉTRICA

**53025**

3,50€



3M  
x16mm

**53026**

5,50€



5M  
x25mm

**53027**

7,50€



7,5M  
x25mm



## MÓDULO EVA DE MEDIÇÃO PARA CARRO DE FERRAMENTAS

**13668**

19,00€



## X-ACTO PROFESSIONAL

**51909**

2,50€

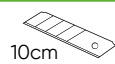

10cm

CABO ANTIDSLIZANTE

MUITO RESISTENTE

EM EXPOSITOR DE 24 UDS



## MAGNETIZADOR / DESMAGNETIZADOR

**53225**

3,50€



## CADEADOS

**53403**

6,00€

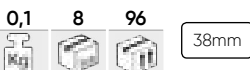

**53405**

5,00€



**53406**

8,00€



**53407**

11,50€



**53408**

17,50€



## CADEADOS RESISTENTES À ÁGUA

**53399**

3,50€



**53400**

4,50€



**53401**

5,00€



**53402**

9,00€



COM COBERTA DE PROTEÇÃO



LONGO

**53404**

6,50€

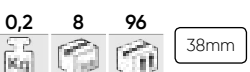

**53409**

9,00€



x3

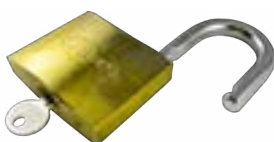

x2



## MARTELO PROFSSIONAL CON PUNHO DE FIBRA

**52182** 2,2 6 12 504 **2 Kg** 297mm

**52184** 4,31 4 128 **4 Kg** 880mm

**52185** 6,97 4 72 **6 Kg** 895mm

**52186** 8,68 2 60 **8 Kg** 900mm



## MARTELO

EN CUNHA

**51674** 0,5 6 36 864 **505 g**

**52565** 1,13 6 24 720 **1 Kg**



MARTELO FORMA DE BOLA

**51918** 1,34 6 18 432 **1 Kg**

**51504** 0,55 4 40 1.280 **454 g**



## MARTELOS PROFSSIONAIS ANTI-RETROCESSO

**52180** 1,33 6 12 360 **1,35 Kg** 355mm

**52181** 1,81 6 12 300 **1,80 Kg** 370mm

**52183** 2,3 6 12 288 **2,20 Kg** 405mm



## MARTELOS NYLON ANTI-RETROCESSO

**52425** 0,7 6 12 500 **Ø 40mm**

**52426** 1,68 2 12 180 **Ø 60mm**

**52427** 2,02 2 12 204 **Ø 70mm**



### PUNTA RECAMBIO

REF.	Ø	kg	pcs	box	€
11212	40mm	0,02	5	100	5,00€
11213	60mm	0,08	5	100	10,55€
11214	70mm	0,11	5	100	12,50€





## ASCIA CON MANICO IN LEGNO

**52188**

15,50€



**52460**

15,00€



**52461**

24,00€



## SERRA COM CABO ERGONÔMICO

**52830**

24,00€



EM EXPOSITOR  
DE 10 UDS

## SERRA

**52831**

18,00€

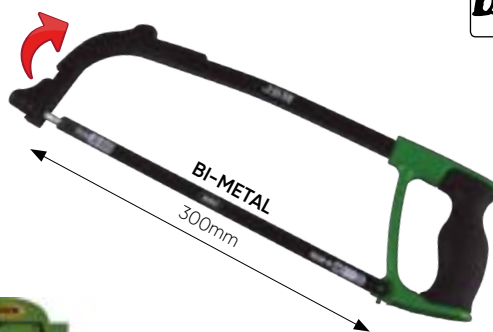

EM EXPOSITOR  
DE 10 UDS

FOLHA PARA SERRA  
PARA REF. 52830 / 52831 / 51675

**12060**

2,50€



## JOGO DE 5 LIMAS DE AÇO

**51853**

18,00€

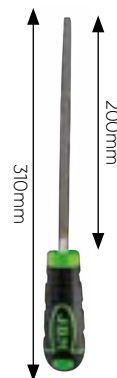

8"

310mm



## JOGO DE 3 ESPÁTULAS DE AÇO

**51951**

15,60€



- Cabo ergonômico.

## KIT DE 4 ESPÁTULAS DE AÇO

**53339**

9,50€



2, 3, 4, 6"



## FERRAMENTA DE VEDAÇÃO DE SILICONE

**54017**

12,00€

0,15

20

40

40mm

305mm

115mm

Este kit permitirá que você restaure a lacuna e remova resíduos de adesivo, além de melhorar a aderência e a aparência da superfície.

- Um raspador de aço inoxidável remove o adesivo antigo
- Espátula de silicone remove saliências e amassados na superfície.
- A ferramenta é adequada para alisar juntas e linhas de vedação e vai lidar com a maioria dos produtos de silicone, quaisquer bordas, cantos e costuras



Inclui cinco almofadas de silicone de reposição (3R, 6R, 10R, 13R, 17R)

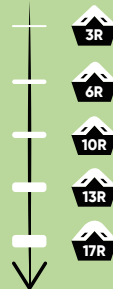

Esta ferramenta pode ser usada para casa, cozinha, banheiro, janelas, conexões de pia, etc.

## ESCOPRO

**53120**

6,00€

0,56

6

24

150mm

**53121**

8,00€

0,55

6

24

720

250mm

**53122**

9,50€

0,9

6

12

432

350mm

ACO  
45C



## CONJUNTO DE 4 ESCOPROS

**53083**

54,50€

1,09

10

20

ACO  
SNCM+V

18x125,  
21x150,  
26x200,  
29x250mm



## JOGO DE 5 ESCOPROS

**52014**

14,00€

0,47

10

40

3.840

10, 11, 12, 14, 16mm

ACO  
45C

155mm



## JOGO DE 5 PONTEIROS

**52049**

14,00€

3, 4, 5, 6, 7mm

0,43  
10  
40  
3.840

ACO  
45C

150mm



## JOGO DE 5 PUNÇÕES

**52013**

14,00€

4, 5, 6, 7, 8mm

0,38  
10  
40  
3.840

ACO  
45C

150mm

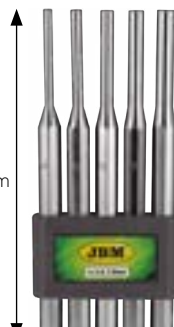

## JOGO DE 6 PUNÇÕES

**53095**

18,00€

0,8

6

24

CrV  
3, 4, 5, 6,  
7, 8mm

150mm

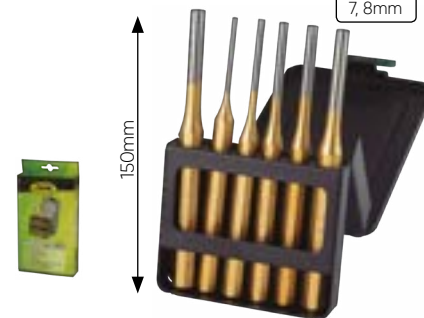

## REBITADOR DE CHARNEIRA MULTI-FUNCIONAL

**53993**

66,50€

1,82

5

10

- Cabeça giratória de 360°
- Compacto, permite que você trabalhe facilmente em pequenos espaços
- O desenho permite o trabalho com uma mão

Inclui:

- Brocas de rebite padrão 2,4 mm (3/32") - 3,2 mm (1/8") - 4,0 mm (5/32") - 4,8 mm (3/16")
- Perfuradores para porcas de rebite M3x0,5 - M4x0,7 - M5x0,8 - M6x1
- Perfuradores para rebites M6x1 - M5x0,8 - M4x0,7
- 3 chaves 5,5x8,5mm - 12x17mm - 15x19mm
- Suporte de fuso M6x1 - M5x0,8 - M4x0,7 - M3x0,5"



2,4mm (3/32")  
4,0mm (5/32")  
4,8mm (3/16")



## ALICATE DE REBITAR COMPACTO 200MM / 8"

52595

1,30 10 140

58,00€



200mm

8"

M3, M4, M5, M6



## MÁQUINA DE REBITES COMPACT 200MM / 8"

52462

0,56 5 30 900

24,00€



8"

200mm

2,4mm (3/32)  
3,2mm (1/8)  
4,0mm (5/32)  
4,8mm (3/16)



13667

MÁQUINA REBITES + REBITES EVA PARA CARRO DE FERRAMENTAS

18,00€

0,83 10 360



## MÁQUINA DE REBITES 300MM / 12"

52463

0,74 20 280

24,50€



300mm

12"

3,2mm (1/8)  
4,0mm (5/32)  
4,8mm (3/16)



## MÁQUINA DE REBITES 400MM / 16"

52464

0,68 5 10 210

39,00€



400mm

16"

2,4mm (3/32)  
3,2mm (1/8)  
4,0mm (5/32)  
4,8mm (3/16)  
6,4mm (1/4)



## ALICATE DE REBITAR 400MM / 16"

52596

3,07 5 75

112,00€



400mm

16"

M3, M4, M5, M6, M8, M10, M12



## ALICATE DE REBITAR AUTOMÁTICO 440MM / 17"

52597

3,25 5 80

128,50€



440mm

17"

M3, M4, M5, M6, M8, M10, M12



## PEÇA DE REPOSIÇÃO PARA 52595, 52596, 52597



REF.	CARACTERÍSTICAS	€
13226	M3 0,03 100	4,50 €
13227	M4 0,04 100	4,50 €
13228	M5 0,04 100	4,50 €
13229	M6 0,04 100	4,50 €

REF.	CARACTERÍSTICAS	€
13230	M8 0,04 100	4,50 €
13231	M10 0,05 100	4,50 €
13232	M12 0,05 100	4,50 €

## REBITADORA DE EMPURRAR 10"

53331

0,80 5 20 280

29,50€



250mm 10"



2,4mm (3/32)  
3,2mm (1/8)  
4,0mm (5/32)  
4,8mm (3/16)  
6,4mm (1/4)

## MÁQUINA DE REBITES 8"

53332

1,65 5 10 280

32,00€



200mm 8"



2,4mm (3/32)  
3,2mm (1/8)  
4,0mm (5/32)  
4,8mm (3/16)

## MÁQUINA DE REBITES + CAIXA DE REBITES PLÁSTICOS

52609

0,50 10 20 240

29,00€



Ø 6,6mm x 17,2mm (10 u.)  
Ø 6,3mm x 25,2mm (10 u.)  
Ø 5mm x 17,2mm (10 u.)  
Ø 5mm x 15,8mm (10 u.)



### REBITES PLÁSTICOS

REF.	Ø				€
13674	6x19,3mm	0,01	25	1.000	0,50€
13675	6x17,8mm	0,01	25	1.000	0,50€
13676	6x25,5mm	0,01	25	1.000	0,50€
13677	6x24,5mm	0,01	25	1.000	0,50€
13678	6x24mm	0,01	25	1.000	0,50€

## MÁQUINA DE REBITES DE AR

52575

1,71 5 10 200

99,50€



2,4mm (3/32), 3,2mm (1/8)  
4,0mm (5/32), 4,8mm (3/16)

- Tamanho: 3/16" - 5/32" - 1/8" - 3/32".
- Tração: 1586lbs / 720 kgs.
- Rod: 9/16" - 14mm.
- Binário max. 60FT LB / 23-69NM.
- Entrada de ar: 1/4".
- Consumo de ar médio: 0.03Cfm/0.86L/min.

- Inclui:
- 2 Multi-tool
  - Quick
  - O-rings



REBITES DISPONÍVEIS EN PÁG. 319

## ROQUETE DE 72 DENTES COM CHAVES

54028

1,22 4 24 384

29,00€



1/2"

10, 11, 12, 13, 14, 15, 16, 17, 18, 19mm



52948

1,22 4 24 384

27,00€



1/2"

10, 11, 12, 13, 14, 15, 16, 17, 18, 19mm



54029

1,22 4 24 384

29,50€



1/2"

10, 11, 12, 13, 14, 15, 16, 17, 18, 19mm



54030

0,35 6 36 864

18,00€



1/4"

4, 5, 6, 7, 8, 9, 10, 11, 12, 13mm



54031

0,35 6 36 864

18,00€



1/4"

4, 5, 6, 7, 8, 9, 10, 11, 12, 13mm



52949

1,22 4 24 384

29,00€



1/2"

10, 11, 12, 13, 14, 15, 16, 17, 18, 19mm



52950

0,35 6 36 864

17,00€



1/4"

4, 5, 6, 7, 8, 9, 10, 11, 12, 13mm



52951

0,34 6 36 864

17,50€



1/4"

4, 5, 6, 7, 8, 9, 10, 11, 12, 13mm





# JOGO DE 3 CHAVES CATRACA ENCURTADAS

**53671**

37,00€

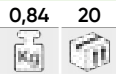

- Completude:  
Alça de catraca curta de 1/4".  
Alça de catraca curta de 1/2".  
Alça de catraca curta de 3/8".

APRESENTAÇÃO EM EVA



**72** 3 PCS

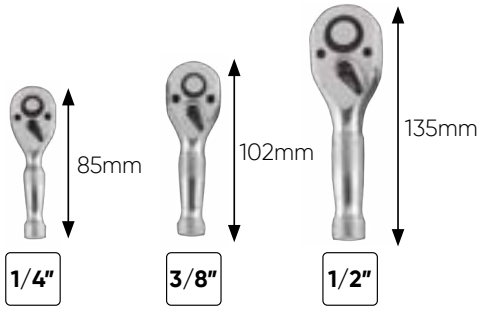

KIT DE REPARO PARA CHAVE CATRACA 1/2"

**15140** 0,20 50  
12,00€

KIT DE REPARO PARA CHAVE CATRACA 3/8"

**15139** 0,15 50  
10,50€

KIT DE REPARO PARA CHAVE CATRACA 1/4"

**15138** 0,10 50  
9,50€

## ROQUETE DE 72 DENTES

CROMADO

CINCADO

**54022**

9,50€



1/4"

145mm

**53098**

11,00€



1/4"

145mm

**54023**

12,50€



3/8"

200mm

**53099**

13,00€



3/8"

200mm

**54024**

17,00€



1/2"

255mm

**53100**

17,00€

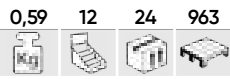

1/2"

255mm

54022/54023/54024



53098/53099/53100



EM EXPOSITOR DE 12 UDS

54018/54019/54021



51382/51270/51921



EM EXPOSITOR DE 12 UDS

## ROQUETE DE 24 DENTES CINCADA

**51285**

9,00€



1/4"

155mm



**51287**

14,00€



1/2"

260mm



EM EXPOSITOR DE 12 UDS

## ROQUETE DE 72 DENTES CINCADA

**52207**

16,50€



1/4"

85mm



EM EXPOSITOR DE 12 UDS

## ROQUETE DE 72 DENTES ARTICULADA

**52587** 0,16 12 144 3.456 **1/4"** 175mm

28,50€



**1/4"** 175mm



EM EXPOSITOR DE 12 UDS



**51305** 0,31 12 48 816 **1/2"** 170mm

21,50€



**1/2"** 170mm

72



EM EXPOSITOR DE 12 UDS



## ROQUETE DE 72 DENTES COM CABEÇA GIRATÓRIA

**51405** 0,15 12 48 1.008 **1/4"** 145mm

21,10€



**1/4"** 145mm

72



EM EXPOSITOR DE 12 UDS



## ROQUETE DE 48 DENTES COM CABEÇA GIRATÓRIA

**52585** 0,15 12 72 2.160 **1/4"** 185mm

31,50€



**1/4"** 185mm

48



EM EXPOSITOR DE 12 UDS

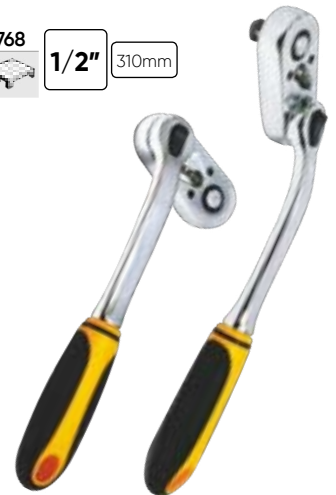

## ROQUETE EXTENSÍVEL 72 DENTES

**53346** 0,25 6 12 **1/4"** 165-215mm

18,00€



**1/4"** 165-215mm

72

EXTENSÍVEL



EM EXPOSITOR DE 6 UDS



53346

CABO EXTENSÍVEL



EM EXPOSITOR DE 6 UDS

51307



## ROQUETE ARTICULADA EXTENSÍVEL DE 1/2" 72 DENTES

**52197** 1,04 6 12 480 **1/2"** 350-490mm

36,00€



**1/2"** 350-490mm

72

ROTAÇÃO 180°

CABO EXTENSÍVEL



EM EXPOSITOR DE 6 UDS





## CATRACA ALONGADA DE 72 DENTES

**53886** 0,27 10 40 **1/4"** 305mm  
18,00€



REPUESTO 1/4" PARA REF.53886  
**15149** 0,05 100  
4,50€

**53887** 0,68 10 20 **3/8"** 457mm  
26,00€

REPUESTO 3/8" PARA REF.53887  
**15147** 0,20 100  
4,50€

**53888** 1,27 4 16 **1/2"** 609mm  
32,50€

REPUESTO 1/2" PARA REF.53888  
**15148** 0,20 100  
4,50€



## CATRACA ALONGADA DE 72 DENTES

**53883** 0,27 10 40 **1/4"** 305mm  
16,50€



REPUESTO 1/4" PARA REF.53883  
**15149** 0,05 100  
4,50€

**53884** 0,61 10 20 **3/8"** 457mm  
26,00€

REPUESTO 3/8" PARA REF.53884  
**15147** 0,20 100  
4,50€

**53885** 1,25 4 16 **1/2"** 609mm  
30,50€

REPUESTO 1/2" PARA REF.53885  
**15148** 0,20 100  
4,50€

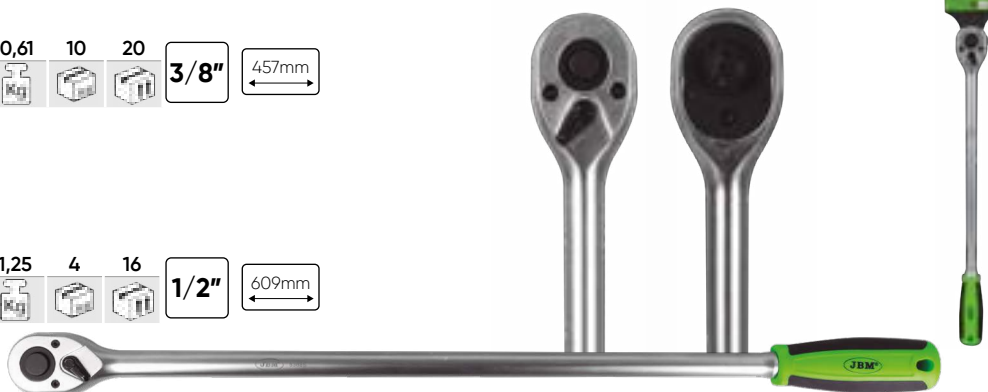

## ROQUETE FLEXÍVEL DE 72 DENTES DE 3/8"

**51801** 0,57 40 160 **3/8"** 500mm  
62,00€

- Ideal para locais de difícil acesso.



## CHAVE CRUZ JUNTA SOLDADA

**51661** 1,17 5 20 480  
11,50€

355mm 17, 19, 21mm

**1/2"**

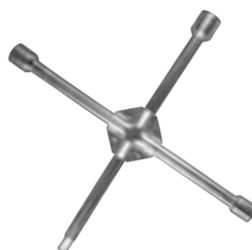

**52881** 1,4 10 420  
17,00€

400mm 17, 19, 21, 22mm

**1/2"**



**52880** 3,75 5 100  
38,50€

700mm 24, 27, 32mm

**3/4"**

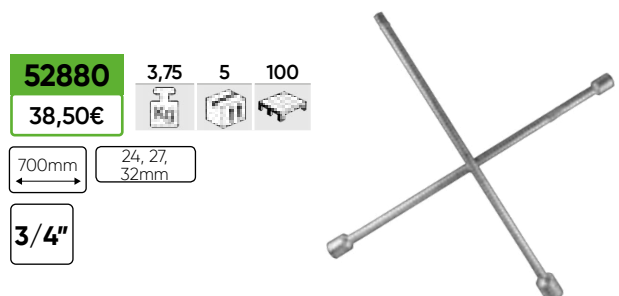

## ADAPTADOR DE ENCAIXE

**53478** 0,5 5 100 700 **1/4"** 115mm  
5,00€

**53479** 0,15 5 50 300 **3/8"** 200mm  
6,50€

**53468** 0,35 6 48 **1/2"** 250mm  
10,50€

**53480** 1,35 5 20 300 **3/4"** 460mm  
19,50€

**53481** 2,85 5 300 **1"** 550mm  
29,30€



## CHAVE ARTICULADA

**52524** 3,65 3 6 192 **3/4"** 1.020mm  
51,50€

**52526** 1,83 5 10 500 **1/2"** 600mm  
27,50€

**52525** 0,78 10 20 1.920 **1/2"** 430mm  
12,50€

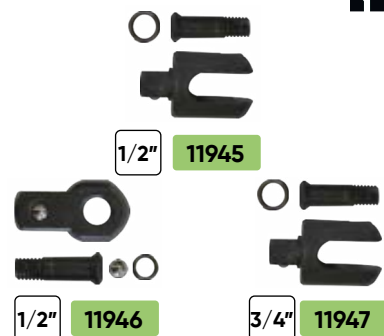
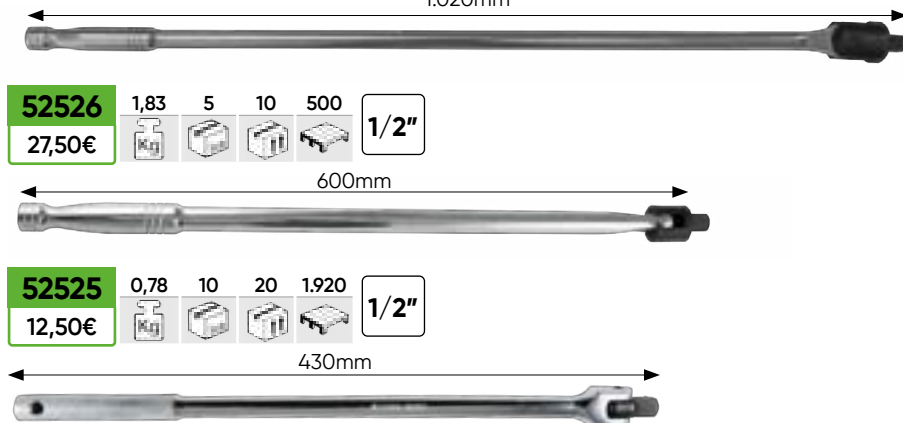

REF.	"	PARA	🔧	📦	📦	€
11945	1/2"	52526	0,02	25	100	7,00€
11946	1/2"	52525	0,06	25	300	4,50€
11947	3/4"	52524	0,01	10	40	19,00€

## KIT DE AUMENTOS 1/4"

**51447** 0,34 20 1.000  
16,00€



**1/4"** 50, 75, 100, 152, 227mm

### DESMANCHA DISPONÍVEL

REF.	mm	🔧	📦	📦	€
14026	50mm	0,03	5	100	5,50 €
14027	75mm	0,04	5	100	5,60 €
14028	100mm	0,06	5	100	7,00 €
14029	152mm	0,08	5	100	8,50 €
14030	227mm	0,11	5	100	9,50 €



## KIT DE AUMENTOS 1/4" COM PÉ REDONDO

**51805** 0,34 5 20 1.000  
17,00€



**1/4"** 50, 75, 100, 152, 227mm

### DESMANCHA DISPONÍVEL

REF.	mm	🔧	📦	📦	€
12995	50mm	0,03	5	100	7,00€
12996	75mm	0,04	5	100	7,00€
12997	100mm	0,06	5	100	7,50€
12998	152mm	0,08	5	100	9,00€
12999	227mm	0,11	5	100	9,50€



## KIT DE AUMENTOS DE 1/2" COM PÉ REDONDO

**51448** 2,38 5 280  
51,35€



**1/2"** 50, 125, 250, 380, 510mm

### DESMANCHA DISPONÍVEL

REF.	mm	🔧	📦	📦	€
14978	50mm	0,09	5	100	7,50€
14979	125mm	0,21	5	100	9,00€
14980	250mm	0,40	5	100	13,00€
14981	380mm	0,62	5	50	22,50€
14982	510mm	0,83	5	50	27,50€





## AUMENTO EXTENSÍVEL DE 1/2" COM PÉ REDONDO

51479

0,65 12 24 1.056

29,00€



260-410mm

1/2"



EM EXPOSITOR  
DE 12 UDS



6 POSIÇÕES

## PESCA PEÇAS FLEXÍVEL COM PONTA DE 4 GARRAS

51526

0,09 12 144 1.728

9,80€



500mm

Ø 20mm

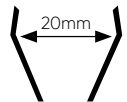
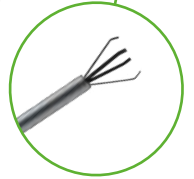

## PESCA PEÇAS MAGNETICO COM LED NA PONTA

52473

0,18 10 60 900

8,00€



x1

545mm

Ø 15mm



## PESCA PEÇAS MAGNÉTICO EXTENSÍVEL

52472

0,04 12 108 4.320

4,90€



135-600mm

Ø 10mm



2,5 Kg



## PESCA PEÇAS FLEXÍVEL COM PONTA MAGNÉTICA

51525

0,14 10 60 1.440

9,80€



500mm

Ø 7mm



0,5 Kg



EXTRAFINO

## PESCA PEÇAS MAGNÉTICO COM PONTA DE LED

51272

0,08 12 72 1.440

7,50€



90-810mm

Ø 15mm

x1



EM EXPOSITOR  
DE 12 UDS

## ESPELHO TELESCÓPICO ARTICULADO

52468

0,09 12 48 2.688

5,90€



280-445mm



Ø 50MM

## NAVALHA COM FUNÇÃO CORTA-CINTS E PONTEIRA QUEBRA-VIDROS

**52786** 0,16 12 60 2.100  
14,00€

COM SEGURO  
ANTIBLOQUEIO

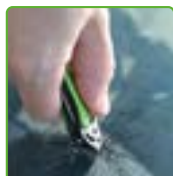

## CORTA TUBOS

**52878** 0,22 10 50 1.500  
11,20€

3-32mm

**52879** 0,24 10 50 1.500  
11,20€

3-35mm



**53517** 0,13 10 60 600  
9,50€

Ø max:  
30mm



**52877** 0,43 48 720  
13,80€

42mm



REF.	DESCRIÇÃO	PARA	Q	€
12964	Rueda de acero	52878	0,01	1,50€
12965	Rueda de acero	52879	0,01	2,00€

## CURVA TUBOS 6-8-10mm

**52905** 0,50 10 30  
28,00€

6, 8, 10mm

TUBOS EM ALUMÍNIO,  
COBRE E AÇO



GRAUS  
MARCADOS

## STRIPPER PARA A REMOÇÃO DE ISOLAMENTO DE FIOS

**53591** 0,1 10 100  
5,50€

↑ 28mm  
↓ 8mm



8-28mm

- Faixa de corte: 8-28mm.
- Comprimento do produto: 170 mm.
- Comprimento da tela: 20mm.
- Profundidade do gancho: 5mm.



## ALICATES DE DESENCAPAR MINI

**53411** 0,05 12 120  
5,00€

127mm

**53412** 0,05 12 120  
4,00€

94mm



53411



53412

## ALICATE PARA EXTRAÇÃO DE GRAMPOS DE CARROCERIA

**53385** 0,15 6 54 499  
18,00€



CORTAR



SEGURAR



BORDEAR

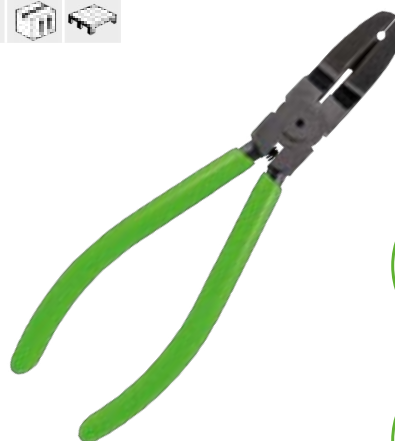

- PONTA EM ÂNGULO:
- Desenhado para extrair/cortar molas /clips facilmente e sem danos.
  - Permite um fácil acesso a áreas pequenas.



## ALICATE PARA DESCARNAR FIOS AUTO-AJUSTÁVEL

**51972**

0,25 10 100 800

0,08-6mm

12,00€



- Para descarnar cabos de plástico ou boracha, individual como múltiplo, com secções desde 0.25 a 2.5mm<sup>2</sup>.
- Ajuste automático de largura para descarnar diferentes fios.
- Em cabos de cobre ou alumínio, possibilidade de descarnar vários cabos de uma vez a partir de 2.5mm<sup>2</sup> como máximo.
- Possibilidade descarnar cabo individual a partir de 0.25mm<sup>2</sup>.
- Não provoca danos no fio condutor.
- Alta durabilidade.



## ALICATE PARA TERMINAIS

PARA TERMINAIS PRÉ-ISOLADOS E NÃO ISOLADOS

**52761**

0,25 12 72 1.296

9"

8,00€



**53932**

0,25 12 72 1.296

9"

8,00€



ALICATE MULTIUSOS + TERMINAIS EVA PARA CARRO DE FERRAMENTAS

**13669**

0,61 10 360

18,00€

PARA TERMINAIS NÃO ISOLADOS

**52762**

0,25 12 72 1.296

8 - 3/4"

9,00€



## JOGO DE ALICATES PARA DESCONEXÃO DO TUBO DE COMBUSTÍVEL

**53445**

0,35 12 48 384

17,00€



APLICAÇÃO ESPECIAL

5/16" 8mm Ø

3/8" 10mm Ø

## ALICATES DE DESENCAPAR MINI

**53604**

3,7 5 120

800mm

Seção de corte max. Ø 550 mm2

111,00€



**53603**

1,75 5 300

550mm

Seção de corte max. Ø 250 mm2

44,00€



**53602**

0,6 5 300

360mm

Seção de corte max. Ø 125 mm2

27,50€



53602

53603

53604

## CORTADORES PARAFUSO

**52955**

0,77 20 200

12"

300mm

HRC 30 Ø 4-5mm

21,00€



**52956**

0,95 20 200

14"

350mm

HRC 30 Ø 5-7mm

22,00€



**52957**

1,47 12 204

18"

450mm

HRC 30 Ø 6-8mm

25,50€



**52958**

2,41 10 168

24"

600mm

HRC 30 Ø 8-10mm

30,95€



**52959**

3,78 5 100

30"

750mm

HRC 30 Ø 10-13mm

38,65€



**52960**

4,75 4 96

36"

900mm

HRC 30 Ø 12-16mm

47,05€



52955

52956

52957

52958

52959

52960

## TESOURAS DE ELECTRICISTA

**52152**

0,08 12 96 1.440

140mm

13,50€



AÇO INOXIDÁVEL

45mm

## ALICATE SEEGER BOCA RETA

PARA INTERIORES

**53549** 0,4 5 30  
13,30€



330mm 13"

**52964** 0,23 6 60 1.260  
9,00€



225mm 9"

**51018** 0,15 5 100 1.400  
6,50€



180mm 7"



PARA EXTERIORES

**53547** 0,4 5 30  
13,50€



330mm 13"

**52966** 0,25 5 60 1.440  
9,00€



225mm 9"

**51017** 0,13 5 100 1.400  
6,50€



180mm 7"



CrV



## ALICATE SEEGER BOCA CURVA

PARA INTERIORES

**53550** 0,4 5 30  
13,30€



330mm 13"

**52965** 0,24 6 60 1.440  
9,00€



225mm 9"

**51021** 0,16 5 100 1.400  
6,50€



180mm 7"



PARA EXTERIORES

**53548** 0,4 5 30  
13,30€



330mm 13"

**52967** 0,24 6 60 1.440  
9,00€



225mm 9"

**51020** 0,13 5 100 1.400  
6,50€



180mm 7"



CrV



## MÓDULO ALICATES SEEGER EVA 8"

**15454** 0,95 10 220  
33,00€



	Ø	€
10526	ALICATE SEEGER PARA INTERIORES BOCA RETA 8"	0,21 10,00€
10642	ALICATE SEEGER PARA EXTERIORES BOCA RETA 8"	0,22 10,00€
10643	ALICATE SEEGER PARA INTERIORES BOCA CURVA 8"	0,21 10,00€
10644	ALICATE SEEGER PARA EXTERIORES BOCA CURVA 8"	0,22 10,00€



8"

## KIT DE ALICATES SEEGER COM PONTA INTERCAMBIÁVEL

**53389** 1,15 10 160  
31,50€



Ângulo de pontas:  
90° / 45° / 15° / 0°

10"

- Contiene:
- Alicates interno.
  - Alicates externo.
  - 16 pontas de diferentes ângulos.
  - 8 tornillos.



## JOGO 3 ALICATE PRESSÃO EXTRA-LARGAS

**52982** 1,6 4 8 400  
49,00€



37cm: ponta recta  
36cm: ângulo de 45°  
34cm: ângulo de 90°

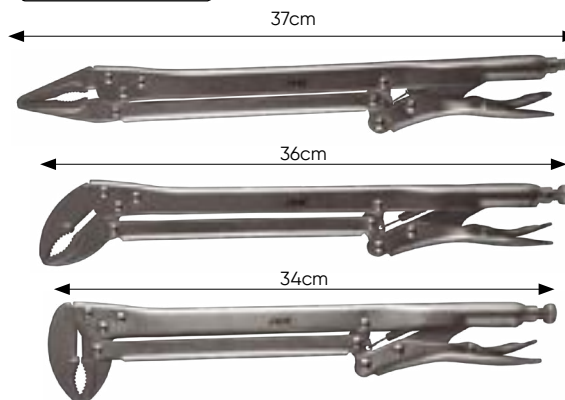



## ALICATE EXTRA-LONGO

RETO

**52846**

0,4 60 1.500

37,80€

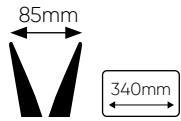

CURVADO 45°

**52847**

0,4 60 1.500

37,80€

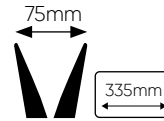

## JOGO ALICATES PONTA 0°, 45°, 90°

**52272**

1 5 10 280

28,00€

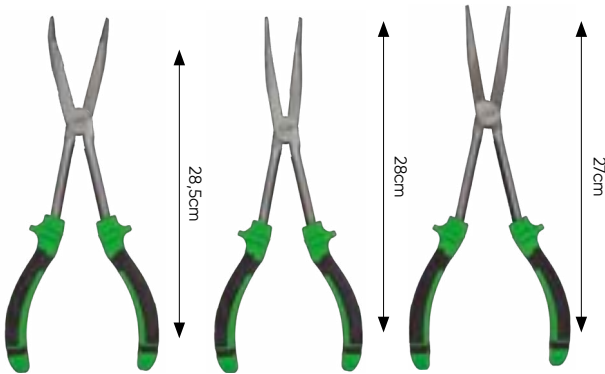

## JOGO DE 5 ALICATES EM CAIXA

**51812**

1,45 5 10 240

44,00€



## ALICATE EXTENSÍVEL

**52052**

1,88 5 10 400

46,50€



**50567**

0,34 10 60 1.020

9,60€



## JOGO DE 6 ALICATES MINI DE 120mm

**50580**

0,47 5 40 1.200

11,00€



- Alicate Universal.
- Alicate Ponta.
- Alicate corte.
- Alicate descamar cabos.
- Alicate SEEGER.
- Alicate universal avião.

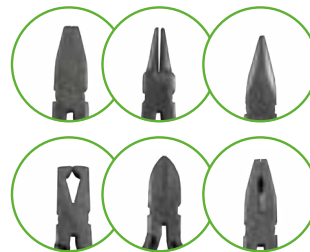

## ALICATE MINI MULTIUSOS

**52412**

0,09 24 144 5.760

5,00€



105mm

### CONTÉM

- x2 chaves de fenda plano
- x1 ponta estrela
- x1 saca-rolhas
- x1 abre-latas
- x1 lima 25mm
- x1 folha de serra 40mm
- x1 folha de corte 40mm



## ALICATE UNIVERSAL

**53911**  
8,00€

0,2 6 60 6"  
160mm



**54015**  
9,00€

0,20 6 60 1.440 7"  
180mm

**53967**  
9,50€

0,30 6 60 1.440 8"  
200mm



53911/54015/53967

## ALICATE CORTE LATERAL

**53905**  
7,00€

0,2 6 60 1.440 6"  
160mm



**53906**  
8,00€

0,20 6 60 1.440 7"  
184mm



## ALICATE PONTAS

**53908**  
7,00€

0,15 6 60 6"  
160mm



**53909**  
9,00€

0,19 6 60 8"  
200mm

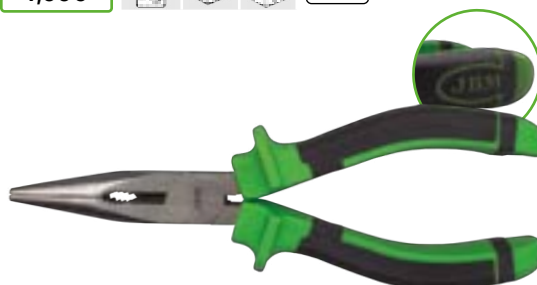

## ALICATE DE PONTA ESPECIAL TERMINAIS

**53976**  
8,00€

0,20 6 60 1.440

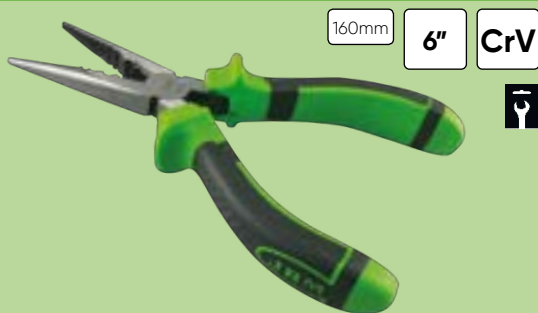

## ALICATE PARA ABRAÇADEIRAS

**53390**  
34,50€

0,85 10 20 480



CONJUNTO DE PEÇAS DE REPOSIÇÃO PARA 53390

**14180**  
7,90€

0,01 100

**51995**  
24,50€

0,59 5 40 480



CONJUNTO DE PEÇAS DE REPOSIÇÃO PARA 51995

**14179**  
8,50€

0,01 100

## ALICATE PARA ABRAÇADEIRAS DE TUBAGEMS DE ESCAPE

**53396**  
18,00€

0,5 5 50

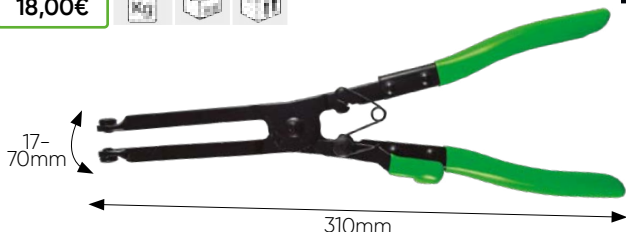

## ALICATE PARA ABRAÇADEIRAS CLIC-R

**52791**  
18,00€

0,27 5 50 1.500



- Para o tipo de Clic e Click-R.

# JOGO DE ALICATES PARA ABRAÇADEIRAS

**52050**

**98,00€**



- Alicates para braçadeiras que permitem a extração de abraçadeiras auto-ajustáveis de plástico ou de ferro com diâmetros de 18mm a 47mm.
- Alicates para abraçadeiras com ponta "+".
- Alicates para abraçadeiras com ponta giratória.
- Alicates para abraçadeiras lisas. A ponta gira 360° para agarrar em qualquer ângulo. Para abraçadeiras modernas.
- Alicates para extração de tubos, muito útil para a fácil extração de tubos de vazio e combustível de 5/32" até 1/2".
- Alicates de anel clic-R. Para desapertar e reajustar abraçadeiras reajustáveis de tipo click o click-R.



REF.	DESCRIÇÃO				€
13707	alicate para braçadeiras elásticas com ponta giratória	0,25	10	40	14,00€
13708	alicate para braçadeiras elásticas	0,25	10	40	14,00€
13709	alicate para braçadeiras elásticas com ponta recta	0,24	10	40	14,00€
13710	alicate para braçadeiras elásticas 45°	0,21	10	40	14,00€

REF.	DESCRIÇÃO				€
52791	alicate para braçadeiras "clic" y "clic-r"	0,27	10	50	18,00€
13712	alicate para la extração de tubos	0,21	10	40	14,00€
51995	alicate para abraçadeiras	0,59	5	40	24,50€



## ALICATE PARA ABRAÇADEIRAS

**52619**

**23,10€**



0-20mm

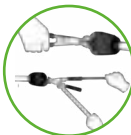

- Furos 1/2" lida para utilizar como uma chave.

**52812**

**64,50€**

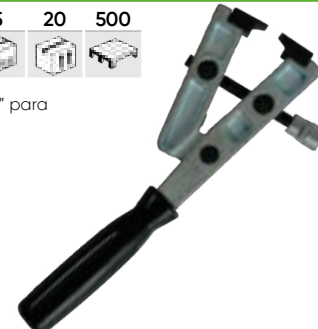

- Soquete feminino de 3/8" para apertar con roquete.

## ALICATE PARA TUBO DE COMBUSTÍVEL

**53487**

**16,00€**



Audi / VW, Fiat, GM, Mercedes

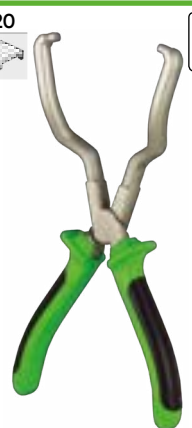

## ALICATE ABRAÇADEIRAS

**52508**

**33,00€**



CrMo

**52509**

**33,60€**

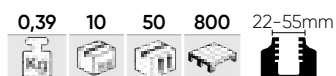

COM ANTIBLOQUEIO



240mm



## ALICATE ESPECIAL TRAVÕES

**52389** 0,32 5 50 600  
**29,00€**

- Para separar os calços dos discos.
- Para sistemas de travões em carros e motociclo.



COM ANTIBLOQUEIO

## CONJUNTO DE 2 PEÇAS RISCADOR

**52852** 0,07 25 100 - Para a remoção de O-rings.  
**6,80€**



## JOGO 12 VAZADORES

**52885** 1,1 5 20 600  
**18,00€**

3, 4, 5, 6, 7, 8, 9, 10, 12, 14, 16, 19mm

**12 PCS**



## ALICATE PARA FREIO DE TAMBOR

**52625** 0,32 6 48  
**9,00€**

- Para remoção e instalação de molas de retorno em freios a tambor.



## ALICATE ESPECIAL PARA PESOS

**51355** 0,45 5 50 500  
**18,00€**

- Tira facilmente e substitui o peso.
- Corta e dobra com facilidade.
- Feito de aço reforçado.
- Inclui cabo ergonómico.
- Com mola automática para manter a sua abertura e facilitar a operação.



## GRAMPEADOR INDUSTRIAL

**53589** 0,55 40  
**12,00€**



1008J-1

PACOTE DE GRAMPEADORES 1000 PCS. PARA REF.53589

**14167** 0,1 50 100  
**2,50€**

## ESCOVAS METÁLICAS

**52760** 0,09 12 120 2.160  
**4,10€**



## ALICATE PERFORADORA ROTATIVA

**52638** 0,26 5 30  
**9,00€**

Ø 2, 2.5, 3, 3.5, 4, 4.5mm

**52515** 0,15 6 72 800  
**9,10€**

**3 PCS**

225mm

- 1 x Latão.
- 1 x Nylon.
- 1 x Aço.



## KIT DE CHAVES INGLESAS DE GANCHO

**53654**

74,00€

1,4

5

180



- Kit composto por 3 chaves de gancho, 3 adaptadores e 2 passadores intercambiáveis.  
- Sua combinação permite trabalhar com diâmetros de 35 mm a 120 mm.

**8**  
PCS

35-60, 60-90,  
90-120mm

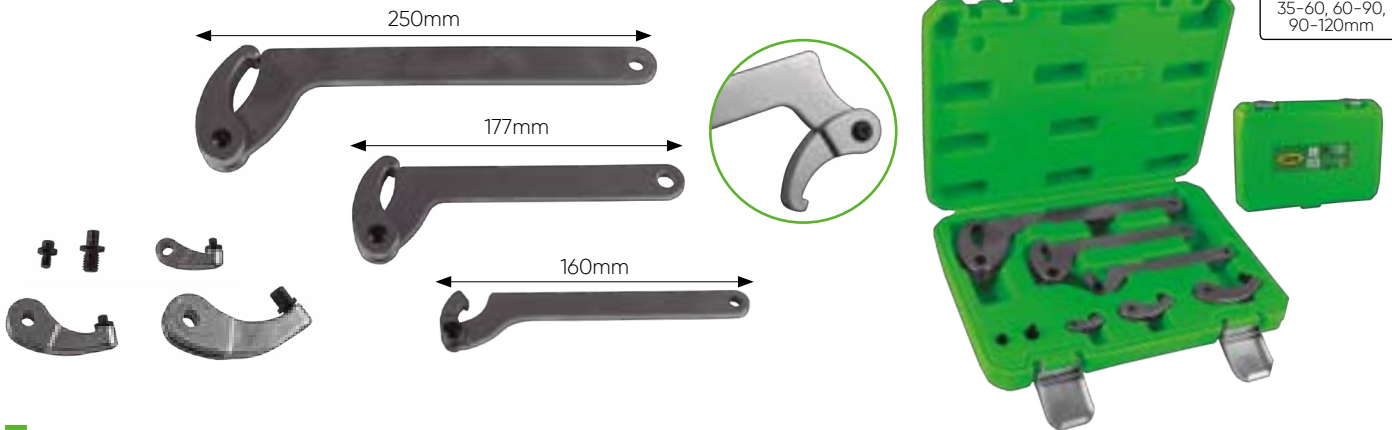

## CONJUNTO PARA CORTAR PORCAS

**53524**

46,00€

1,7

5

10

340



9-12, 12-16,  
16-22, 22-36mm

**4**  
PCS



### DESMANCHA DISPONÍVEL

REF.	DESCRIÇÃO			€
14049	9-12mm	0,11	50	8,00€
14050	12-16mm	0,2	50	10,50€
14051	16-22mm	0,44	50	18,00€
14052	22-27mm	0,65	50	19,50€



## CHAVE INGLESA

### MODELO 3

**53639**

22,50€

0,15

6

96

576



**6"**

150mm

**53640**

29,50€

0,28

6

72

504



**8"**

200mm

**53641**

34,00€

0,50

6

36

1.151



**10"**

250mm

**53642**

42,50€

0,83

6

24

1.200



**12"**

300mm

**53643**

79,00€

1,53

12

336



**16"**

400mm

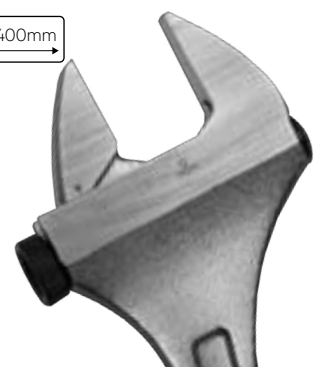

### MODELO 1

**51798**

35,00€

1,96

3

12

295



**18"**

53mm



**52424**

56,00€

3,64

1

5

175



**24"**

62mm



### MODELO 2

**51795**

9,00€

0,28

6

120

3.600



**8"**

22mm



**51796**

14,00€

0,48

6

36

2.400



**10"**

28mm



**51797**

18,00€

0,71

6

24

1.200



**12"**

37mm



51795



51796/51797

## CHAVE DE CANOS

<b>52235</b>	0,85	6	36	1.140	<b>12"</b>	300mm	50mm
11,00€							
<b>52236</b>	1,09	6	24	760	<b>14"</b>	350mm	60mm
12,50€							
<b>52237</b>	0,30	4	12	720	<b>18"</b>	450mm	70mm
17,00€							
<b>52238</b>	3,08	2	12	600	<b>24"</b>	600mm	75mm
23,50€							
<b>53210</b>	4,8	4	128		<b>36"</b>	915mm	100mm
45,00€							

## ALUMÍNIO ALLOY CHAVE DE TUBULAÇÃO

<b>53070</b>	0,68	6	24		<b>12"</b>	270mm	45mm
16,00€							
<b>53071</b>	0,92	4	12		<b>14"</b>	320mm	50mm
19,00€							
<b>53072</b>	1,41	4	16		<b>18"</b>	410mm	70mm
29,00€							
<b>53073</b>	2,12	2	8	1.000	<b>24"</b>	540mm	75mm
46,00€							



## GARAMPOS DE FIXAÇÃO 9 TAMANHOS DIFERENTES

<b>52349</b>	1,25	10	480	90x200mm
18,50€				
<b>52350</b>	1,41	10	540	90x300mm
21,00€				
<b>52351</b>	1,60	10	480	90x400mm
23,00€				
<b>52352</b>	1,99	10	360	120x300mm
27,00€				
<b>52353</b>	2,2	10	350	120x400mm
28,00€				
<b>52354</b>	2,41	6	300	120x500mm
32,00€				
<b>52355</b>	2,62	4	300	120x600mm
36,00€				
<b>52357</b>	4,75	4	125	150x800mm
47,00€				
<b>52358</b>	5,35	2	120	150x1.000mm
54,50€				



52351  
52352  
52355  
52357



52349  
52350  
52353  
52354  
52358



CARROS DE FERRAMENTAS



68

MÓDULOS



76

ACESSÓRIOS E PEÇAS DE REPOSIÇÃO PARA CARROS



78

ARMÁRIOS



79

PONTAS



79

MESAS DE TRABALHO



80

CAIXAS DE FERRAMENTAS



81

TABURETES / CAMAS



83

BIGORNAS / TORNOS



86



# MOBILIÁRIO DE OFICINA



# CARRO DE 12 GAVETAS

**53939**  
1.280,00€

98,7 1 4  
COLUNA COM  
FERROUMENTOS

**53868**  
1.090,00€

83,50 1 4  
VÁCUO

**172**  
PCS

## ACESSÓRIOS E PEÇAS DE REPOSIÇÃO

página 78

ARMÁRIOS

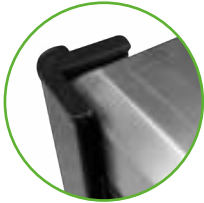

PROTECTOR LATERAL



ENCERRAMENTO COM IMPRENSA GAVETA



SEPARADOR DE FECHAMENTO INDIVIDUAL POR GAVETA

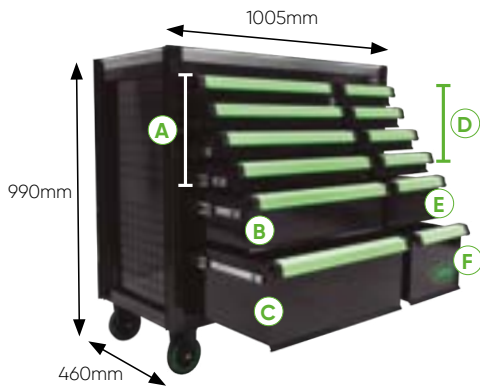

COM MÓDULOS EVA:  
4 MÓDULOS COM ACABAMENTO EM FIBRA DE CARBONO

**53708**  
292,00€

Módulo 1: **14296** 99,00€



### MEDIDAS INTERIOR 1ª COLUNA

GAVETAS MENINHAS (x4)

**A** 75mm 533mm 400mm **35kg**

**B** 154mm 533mm 400mm **35kg**

**C** 233mm 533mm 400mm **35kg**

### MEDIDAS INTERIOR 2ª COLUNA

GAVETAS MENINHAS (x4)

**D** 75mm 265mm 400mm **35kg**

**E** 154mm 265mm 400mm **35kg**

**F** 233mm 265mm 400mm **35kg**

Módulo 2: **14297** 72,50€

Módulo 3: **14298** 44,50€

Módulo 4: **14299** 72,50€





# CARRO 7 GAVETAS - XL

**53912**  
1.280,00€



COM FERRAMENTAS

**53869**  
990,00€



VÁCUO

**53913**  
1.280,00€



COM FERRAMENTAS

**53870**  
990,00€



VÁCUO

**192**  
PCS

# XL

## ACESSÓRIOS E PEÇAS DE REPOSIÇÃO

página 78

### COM MÓDULOS EVA:

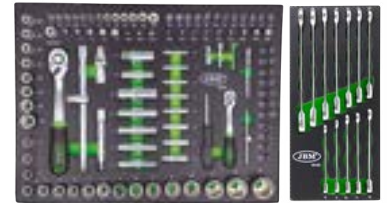

14296

15122

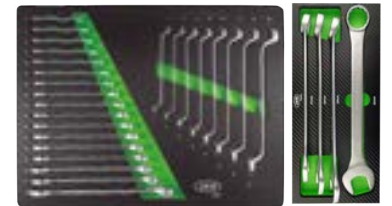

14297

15161

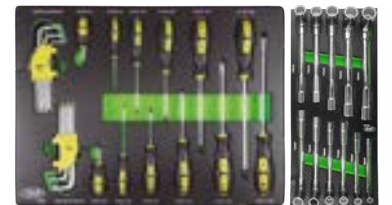

14298

15155



14299

13884

ARMÁRIOS

980mm



980mm

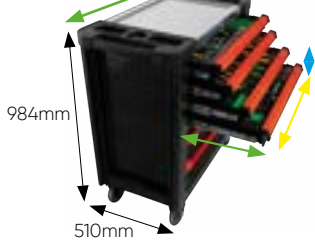

984mm

510mm

### MEDIDAS INTERIOR

#### GAVETAS MENINHAS (x5)



25kg

#### GAVETAS GRANDES (x2)



35kg

SISTEMA DE BLOQUEIO INTERNO PARA SEGURANÇA



SEPARADOR DE FECHAMENTO INDIVIDUAL POR GAVETA

MANUSEIO SEGURO: RODAS GIRATÓRIAS, 2 COM TRAVÃO



SUPERFÍCIE DE TRABALHO AÇO INOXIDÁVEL

PUNHO ERGONÓMICO, MACIO E ANTIDERRAPANTE

LATERAIS PERFURADAS PARA UM GRANDE NÚMERO DE ACESSÓRIOS





# CARRO DE 7 GAVETAS

**53763**

890,00€



**53765**

890,00€



**53900**

890,00€



**53764**

680,00€



**53766**

680,00€



**53901**

680,00€



**172**  
PCS

**350Kg**

## ACESSÓRIOS E PEÇAS DE REPOSIÇÃO

página 78

ARMÁRIOS



### ALTA QUALIDADE

- RESISTENTE A CARGAS PESADAS
- LEVE E FÁCIL DE TRANSPORTAR
- FERRAMENTAS BEM ORGANIZADAS EM MÓDULOS
- CONSTRUÇÃO ROBUSTA E DURÁVEL

LATERAIS PERFORADAS PARA PERMITIR AO USUÁRIO ADICIONAR UM GRANDE NÚMERO DE ACESSÓRIOS



SEPARADOR DE FECHAMENTO INDIVIDUAL POR GAVETA



SISTEMA DE FECHAMENTO CENTRALIZADO

RODAS DE 5", 2 RODAS FIXAS E 2 GIRATÓRIAS, UM COM TRAVÃO



GAVETAS MENINHAS (x6)

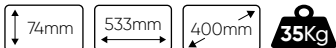

GAVETA GRANDE (x1)

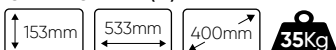

CAPACIDADE DE CARGA DA GAVETA: 40KG.  
CAPACIDADE TOTAL DE CARGA: 125KG.

COM MÓDULOS EVA:  
4 MÓDULOS COM ACABAMENTO EM FIBRA DE CARBONO

**53708**

292,00€

Módulo 1: **14296** 99,00€



Módulo 2: **14297** 72,50€



Módulo 3: **14298** 44,50€



Módulo 4: **14299** 72,50€



# CARRO DE 7 GAVETAS

<b>53661</b> 890,00€	56,5 1 2 COM FERRAMENTAS	<b>53686</b> 890,00€	56,5 1 2 COM FERRAMENTAS	<b>53767</b> 890,00€	74,30 1 4 COM FERRAMENTAS	<b>53904</b> 890,00€	72 1 4 COM FERRAMENTAS	<b>172 PCS</b>
<b>53761</b> 680,00€	56,3 1 2 VACUO	<b>53762</b> 680,00€	56,3 1 2 VACUO	<b>53768</b> 680,00€	59 1 4 VACUO			<b>300 Kg</b>

**ACESSÓRIOS E PEÇAS DE REPOSIÇÃO**  
página 78



**GAVETAS MENINHAS (X5)**  
74mm 533mm 400mm **35Kg**

**GAVETA GRANDE (X2)**  
151,5mm 533mm 400mm **35Kg**

CAPACIDADE DE CARGA DA GAVETA: 35KG.  
CAPACIDADE TOTAL DE CARGA: 300KG.

COM MÓDULOS EVA:  
**4 MÓDULOS COM ACABAMENTO EM FIBRA DE CARBONO**

**53708**  
292,00€

**Módulo 1: 14296 99,00€**



**Módulo 2: 14297 72,50€**



**Módulo 3: 14298 44,50€**



**Módulo 4: 14299 72,50€**



SEPARADOR DE FECHAMENTO INDIVIDUAL POR GAVETA



SISTEMA DE FECHAMENTO CENTRALIZADO



2 RODAS ROTATIVAS



ARMÁRIOS



# GABINETE COM 7 GAVETAS COM KIT DE FERRAMENTAS DE AJUSTE DE SINCRONIZAÇÃO

53951

1.794,00€



53952

1.794,00€



53775

1.108,50€

SET DE 6 MÓDULOS DE SINCRONIZAÇÃO DE MOTOR

diesel gasolina

## ACESSÓRIOS E PEÇAS DE REPOSIÇÃO

página 78

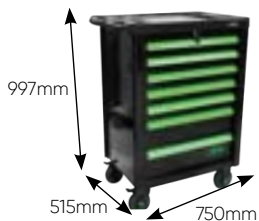

Módulo 5: 53773 293,00€

FIAT / ALFA / LANCIA / OPEL / SUZUKI / FORD



Módulo 6: 53774 189,50€

OPEL / CHEVROLET / SAAB / FIAT / LANCIA / SUZUKI / FORD



Módulo 1: 53769 170,00€

RENAULT / NISSAN / OPEL / VOLVO



Módulo 2: 53770 190,50€

FORD / SEAT / VOLKSWAGEN / MAZDA / VOLVO



Módulo 3: 53771 154,50€

FIAT / FORD / CITROËN / PEUGEOT



Módulo 4: 53772 211,00€

FORD / VAG / MAZDA / VOLVO



ARMÁRIOS





Escolha a cor de carro que deseja e preencha com  
**FERRAMENTAS PARA CHAPEIRA**  
 OU  
**FERRAMENTAS DE MANUTENÇÃO**

**CARRO DE FERRAMENTAS 7 GAVETAS ESPECIAL CHAPEIRO**

<b>53577</b> 990,00€	74,5 1 2	<b>53579</b> 990,00€	74,5 1 2	<b>53580</b> 990,00€	74,5 1 2	<b>53509</b> 482,00€	6 MÓDULOS PARA CARRO DE BATE-CHAPAS:	<b>256 PCS</b>
-------------------------	----------	-------------------------	----------	-------------------------	----------	-------------------------	--------------------------------------	----------------

**Módulo 1:**  
**14059**  
 62,00€

**15 PCS**  
 MANÍVELAS DE NYLON

**Módulo 2:**  
**14060**  
 65,00€

**7 PCS**  
 CONJUNTO DE NIVELAMENTO

**Módulo 3:**  
**14061**  
 93,00€

**7 PCS**  
 BANDEJA COM UM ALICATE

**Módulo 4:**  
**14062**  
 100,00€

**10 PCS**  
 BOMBA DE SUÇÃO E FERRAMENTAS DE REMOÇÃO DE PARA-BRISAS

**Módulo 5:**  
**14063**  
 118,50€

**32 PCS**  
 FERRAMENTAS PARA ENTALHES

**Módulo 6:**  
**14064**  
 39,50€

**11 PCS**  
 PARA ABERTURA DE EMERGÊNCIA

**CARRO DE FERRAMENTAS 7 GAVETAS ESPECIAL MANUTENÇÃO**

<b>53514</b> 990,00€	74,5 1 2	<b>53556</b> 990,00€	74,5 1 2	<b>53557</b> 990,00€	74,5 1 2	<b>256 PCS</b>
-------------------------	----------	-------------------------	----------	-------------------------	----------	----------------

**53469**  
 613,00€

JOGO DE 5 MÓDULOS PARA CARRO DE TROCA DE ÓLEO:

**22 PCS**

**Módulo 1:**  
**14141**  
 104,50€

**22 PCS**  
 EXTRATORES DE FILTRO DE ÓLEO

**Módulo 2:**  
**14142**  
 101,50€

**34 PCS**  
 REPOSICIONADOR DE FREIO

**Módulo 3:**  
**14143**  
 124,00€

**86 PCS**  
 TAMPÃO CARTER E EXTRATORES DE FILTRO DE ÓLEO AJUSTÁVEIS

**Módulo 4:**  
**14144**  
 304,00€

**6 PCS**  
 PISTOLA E VASOS DE IMPACTO

**Módulo 5:**  
**53116**  
 99,00€

**108 PCS**  
 108 PEÇAS CHAVES HEX.



# CARRO DE 7 GAVETAS COM GUÍA TELESCÓPICA COM E SEM FERRAMENTAS

**52393**

1.180,00€

69,5

1

2

COM FERRAMENTAS



**52172**

780,00€

58

1

2

VÁCUO

- Rodas sem montar.

- espessura do metal:  
Gaveta: 0,8mm  
Quadro: 1mm

**179**  
PCS



SUPERFÍCIE DE BORRACHA ANTIDESLIZANTE

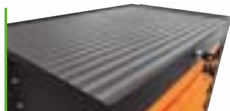

FECHO DE CHAVE



RODAS COM FREIOS



125x50mm



MEDIDAS INTERIOR

GAVETAS MENINHAS (x5)

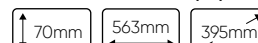

**35kg**

GAVETAS GRANDES (x2)



**35kg**

COM MÓDULOS EVA:

**53708**

292,00€

Módulo 1: **14296** 99,00€

Módulo 2: **14297** 72,50€

Módulo 3: **14298** 44,50€

Módulo 4: **14299** 72,50€

4 MÓDULOS COM ACABAMENTO EM FIBRA DE CARBONO

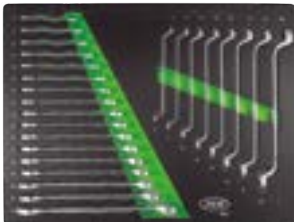

# CARRO DE 9 GAVETAS

**53867**

1.095,00€

73,45

1

4



ACESSÓRIOS E PEÇAS DE REPOSIÇÃO

página 79

COM SEPARADORES



ORGANIZAÇÃO LIVRE

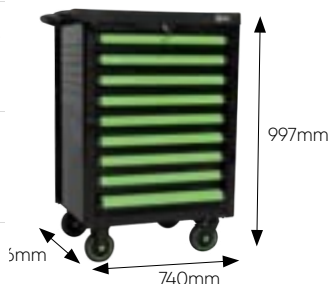

MEDIDAS GAVETA INTERIOR

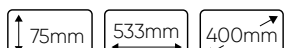

**35kg**

POTREBBE PIACERTI ANCHE...

REF.	mm	kg	PCS	€
15070	67x53mm	0,05	200	0,50€
15071	103x53mm	0,05	200	0,60€
15072	138x53mm	0,05	200	0,70€
15074	210x53mm	0,10	200	1,00€
15075	280x53mm	0,10	200	1,20€

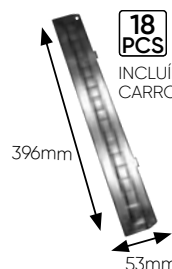

**15076**  
3,50€

0,30 50



**15073**  
1,00€

0,05 200



# CARRO DE FERRAMENTAS COM 1 GAVETA COM GUÍA TELESCÓPICA

53866

615,00€



350Kg

## ACESSÓRIOS E PEÇAS DE REPOSIÇÃO

página 79



BANDEJA / DIVISÓRIA AJUSTÁVEL



SISTEMA DE FECHAMENTO CENTRALIZADO



SUPERFÍCIE DE BORRACHA ANTIDESLIZANTE

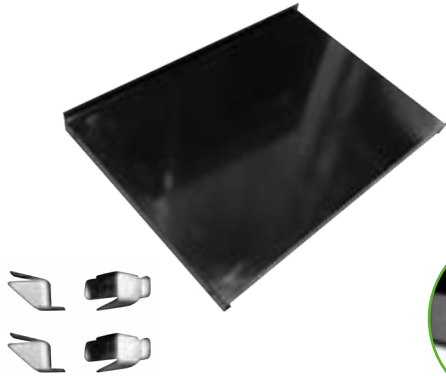

MEDIDAS GAVETA INTERIOR

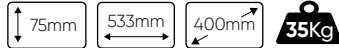

35Kg

## MÓDULOS DE FERRAMENTAS

### MÓDULO DE CHAVES PARA BUJÃO DE CARTER

15084

46,50€

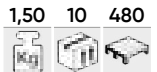

MÓDULO COM ACABAMENTO EM FIBRA DE CARBONO

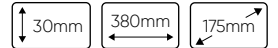

➤ VOCÊ PODE GOSTAR...

15018

46,00€



Também adequado para coletores de óleo 53873 e 53874.







#### CONTÉM

	x2	5/16", 3/8"
	x7	7, 8, 10, 11, 12, 13, 14mm
	x1	10mm
	x1	10mm
	x7	8, 9, 10, 12, 13, 14, 17mm
	x1	T45
	x1	M16
	x1	200mm
	x1	150mm

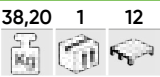

# MÓDULOS DE FERRAMENTAS

## CONJUNTO DE 6 FERRAMENTAS DE SINCRONIZAÇÃO DE MOTOR

<p><b>53775</b> 1.108,50€</p> <p>38,20 1 12</p> <p><b>diesel gasolina</b></p> <p>35mm 530mm 395mm</p>		<p><b>53770</b> 190,50€</p> <p>6,15 3 36</p>		<p><b>53771</b> 154,50€</p> <p>4,05 3 36</p>	
RENAULT / NISSAN / OPEL / VOLVO		FORD / SEAT / VOLKSWAGEN / MAZDA / VOLVO		FIAT / FORD / CITROËN / PEUGEOT	
<p><b>53772</b> 211,00€</p> <p>6,40 3 36</p>		<p><b>53773</b> 293,00€</p> <p>6,60 3 36</p>		<p><b>53774</b> 189,50€</p> <p>6,95 3 36</p>	
FORD / VAG / MAZDA / VOLVO		FIAT / ALFA / LANCIA / OPEL / SUZUKI / FORD		OPEL / CHEVROLET / SAAB / FIAT / LANCIA / SUZUKI / FORD	

+ INFORMAÇÕES DE CADA CONFIGURAÇÃO: KIT DE BLOQUEIO, pág. 238

## CONJUNTO DE 4 MÓDULOS COM ACABAMENTO EM FIBRA DE CARBONO EVA

<p><b>53708</b> 292,00€</p> <p>15,20 1 20</p> <p>30mm 525mm 380mm</p>		<p><b>14296</b> 99,00€</p> <p>6,05 4 80</p>		<p><b>14297</b> 72,50€</p> <p>3,30 4 80</p>		<p><b>14298</b> 44,50€</p> <p>2,10 4 80</p>		<p><b>14299</b> 72,50€</p> <p>3,25 4 96</p>	
---	---	---	---	---	--	---	---	---	---

## MÓDULOS EVA COM ACABAMENTO EM FIBRA DE CARBONO 175x30x380mm



**15122**  
69,00€

1,6 10 220

8, 9, 10, 11, 12, 13, 14, 15, 16, 17, 18, 19mm



**15155**  
56,00€

2,03 10 220

8, 10, 11, 12, 13, 14, 15, 16, 17, 18, 19mm



**15156**  
58,00€

1,8 10 220

21x23, 24x27, 25x28, 30x32 mm

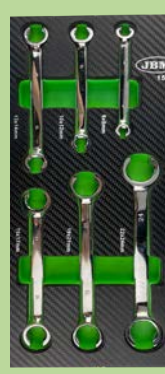

**15157**  
42,00€

0,8 10 220

6x8, 10x12, 13x14, 15x17, 19x21, 22x24 mm



**15158**  
50,00€

1,05 10 220

8, 10, 11, 13, 14, 17, 19 mm



**15159**  
39,00€

0,69 10 220

8x10, 11x13, 14x15, 17x19, 20x22 mm





**15160**  
39,00€



8x9, 10x11, 12x13, 14x15,  
16x17, 18x19 mm



**15161**  
56,00€



27, 29, 30, 32 mm



**15316**  
50,00€



8, 9, 10, 11, 12, 13, 14,  
15, 16, 17, 18, 19mm



**15454**  
33,00€



8"



**15514**  
11,50€



0,05 10 220

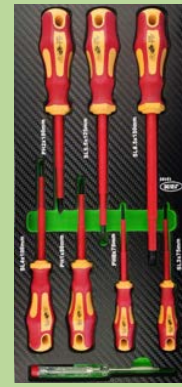

**15162**  
25,50€



0,5 10 220

Dimensões:  
SL 3x75mm  
SL 4x100mm  
SL 5,5x125mm  
SL 6,5x150mm  
PH 0x75mm  
PH 1x80mm  
PH 2x100mm  
Voltímetro 140mm,  
sulco SL 0,5x3,0 mm

## MÓDULOS EVA 175x30x380mm



**53620**  
87,50€



525x30x380mm



**11996**  
44,50€



6x7mm - 20x22mm +  
24x27mm + 30x32mm



**11994**  
33,00€

1/4"



**11997**  
35,00€



6x7mm - 18x19mm +  
20x22mm



**11998**  
48,50€



6x7mm - 18x19mm -  
20x22mm



**51378**  
21,00€



0,81 10 30 240

PH4x200, PH3x150,  
PH2x100, PH2x38, PH1x80,  
PH0x120, PH1x100mm



**53943**  
18,50€



0,80 10 200

PH4x200, PH3x150,  
PH2x100, PH2x38  
PH1x80, PH0x120,  
PH1x100



**53944**  
18,50€



0,80 10 220

SL9x200, SL4x125,  
SL5x100, SL5x80,  
SL6x38, SL6x100,  
SL8x150mm



**53945**  
18,50€



0,60 10 220

T8x75, T9x75,  
T10x75, T15x75,  
T20x75, T25x100,  
T27x100



**14114**  
21,85€



0,93 10 360



**13884**  
12,50€



0,1 10 300

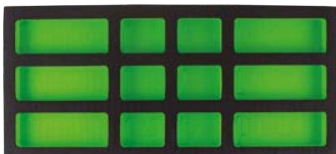

**13923**  
9,00€



0,05 30



**13667**  
18,00€



0,83 10 360



**13668**  
19,00€



0,61 10 300



**13669**  
18,00€



0,61 10 360

# MÓDULOS DE PLÁSTICO 175x30x380mm



**10731**

18,00€

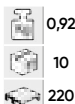

**10732**

18,50€

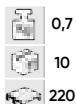

**10733**

17,50€



**10727**

23,00€



**10735**

20,00€



1,7, 2,4,  
2,5, 3cm

**ACESSÓRIOS PARA ARMARIOS** REF. 53514, 53556, 53557, 53577, 53579, 53580, 53661, 53686, 53761, 53762, 53763, 53764, 53765, 53766, 53767, 53768, 53866, 53867, 53868, 53869, 53870, 53900, 53901, 53904, 53912, 53913, 53939, 53951, 53952

## SUPOORTE DE CILINDRO DE AEROSSOL

**15313**

14,00€



## SUPOORTE DE CILINDRO DE AEROSSOL

**14354**

14,00€



## SUPOORTE DE ROLO DE PAPEL

**15068**

18,00€



## PORTADORA DE DOCUMENTOS

**15069**

28,50€



**PEÇAS DE REPOSIÇÃO PARA ARMARIOS** REF. 53661, 53686, 53763, 53764, 53765, 53766, 53866, 53867, 53868, 53869, 53870, 53900, 53901, 53904



14580, 15031,  
15034, 15038



15019

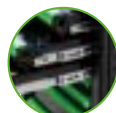

15032



14578



15029, 15030,  
15035, 15036, 15037,  
15042, 15050



15033

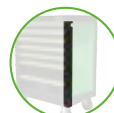

14783

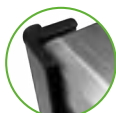

15039, 15058,  
15065



15021, 15023,  
15025, 15040



15022, 15024,  
15026, 15041

REF.	DESCRIÇÃO	📦	📦	📦	€	53661	53686	53763	53764	53765	53766	53866	53867	53868	53869	53870	53900	53901	53904	
14578	Guia de rolamento de esferas grande	1,05	1	25	12,50€	X	X													X
14580	Tampa superior	2,60	3	39	40,50€	X	X													X
14783	Protetor direito	0,25	1	50	5,50€	X	X													X
15019	Retentor	0,05	1	100	6,00€			X		X		X	X	X	X	X	X			
15021	Roda fixa	0,65	1	10	12,50€			X	X			X	X	X	X					
15022	Roda giratória	0,95	1	8	15,00€			X	X			X	X	X	X					
15023	Roda fixa	0,65	1	10	12,50€					X	X					X				
15024	Rueda giratoria	0,95	1	8	15,00€					X	X					X				
15025	Roda fixa	0,65	1	10	12,50€															X
15026	Rueda giratoria	0,95	1	8	15,00€															X
15029	Pega da caixa	0,28	1	50	8,00€			X	X			X	X	X						
15030	Pega da caixa	0,30	1	50	8,00€					X	X									
15031	Tampa superior	2,15	1	2	8,00€			X	X	X	X								X	X
15032	Guia para caixa	1,05	1	9	16,00€			X	X	X	X			X	X	X	X	X		
15033	Pega da caixa estreita	0,30	1	50	6,00€									X						
15034	Tampa superior	-	-	-	56,50€									X						
15035	Pega da caixa	0,36	1	20	8,50€										X					
15036	Pega da caixa	0,36	1	20	8,50€											X				
15037	Pega da caixa	-	-	-	8,00€														X	X
15038	Tampa superior	-	-	-	34,50€										X	X				
15039	Protetor lateral	0,36	1	25	7,50€			X		X		X	X		X	X	X			
15040	Roda fixa	0,66	1	10	12,50€															
15041	Rueda giratoria	0,98	1	8	15,00€															X
15042	Pega da caixa	0,10	1	-	7,50€															X
15050	Pega da caixa	0,10	1	50	9,50€															X
15058	Protetor lateral	-	-	-	7,50€	X	X													
15065	Protetor lateral	0,55	1	12	6,50€										X	X				

COMPATIBILIDADE



# ARMÁRIO DE TRABALHO MULTIMÉDIA COM RODAS

**51456**

**725,00€**



- Rodas sem montar.

SET DE 4 RODAS PARA ARMÁRIO REF. 51456

Ø12cm

2 Rodas com freio + 2 simples

**11313**

**53,50€**



Bandejas ajustáveis cada 70mm

220mm



1165mm

575mm

EXTERIOR

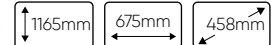

GAVETA SUPERIOR

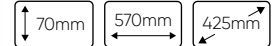

ARMÁRIO INFERIOR

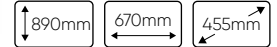

## CAIXA COM 3 GAVETAS

**51576**

**178,00€**



- Rodas sem montar.



## CAIXA COM 3 GAVETAS MAXI

**52373**

**268,00€**



- Rodas sem montar.

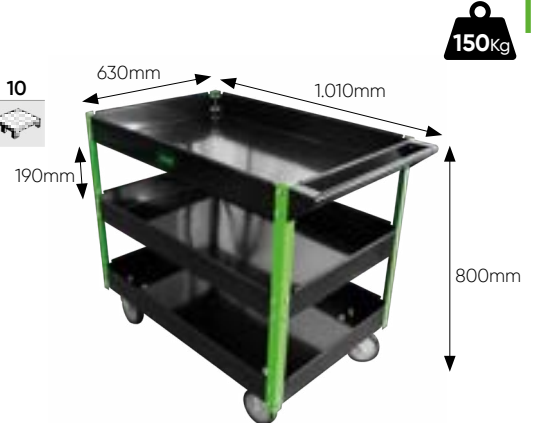

## PAINEL PARA FERRAMENTAS

**52419**

**108,00€**



1.000 x 600mm

**52420**

**135,00€**



1.500 x 600mm

**52421**

**196,50€**



2.000 x 600mm



ACOPLAMENTO QUADRADO

## PONTAS

### CABIDE ESPECIAL CHAVES

**51653**

**9,80€**



PARA REF.: 52419, 52420, 52421

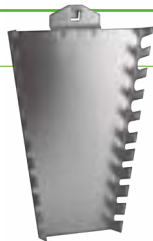

### CABIDE ESPECIAL CHAVES DE FENDA

**51657**

**9,00€**



PARA REF.: 52419, 52420, 52421



PARA REF. 52419, 52420, 52421

**95mm** CABIDE DE PONTA FECHADA  
**51654** 0,09 10 100  
**5,00€**

**3mm** CABIDE DE 2 PONTAS PEQUENAS  
**51655** 0,07 10 100  
**6,00€**

**92mm** CABIDE DE 2 PONTAS COMPRIDAS  
**51658** 0,05 10 100  
**5,50€**

**91mm** CABIDE DE PONTA COMPRIDA  
**51656** 0,07 10 100  
**6,00€**

**200mm** CABIDE DE 2 PONTAS LUNGAS  
**52634** 0,14 10 100  
**6,00€**

**95mm** CABIDE "L" DUPLO LONGO  
**51422** 0,05 100  
**6,00€**

**200mm** CABIDE DE PONTA FECHADA LUNGA  
**52635** 0,14 10 100  
**5,50€**

PARA REF. 51428, 51430, 52705, 52706, 52707, 52708, 52709

**90mm** CABIDE "L" SIMPLE LONGO  
**51419** 0,03 100  
**4,00€**

**30mm** CABIDE CURTO  
**51975** 0,03 100  
**2,00€**

**75mm** CABIDE 2 PONTAS LONGOS  
**51976** 0,03 100  
**4,00€**

PARA REF. 51035, 53661, 53686, 53761, 53762, 53767, 53768, 53904

**95mm** CABIDE "L" DUPLO LONGO  
**51422** 0,05 100  
**6,00€**

## MESA DE TRABALHO COM PAINEL FRONTAL

51035

799,00€

86,5

1

5

600Kg

1,550mm

1,500mm

640mm

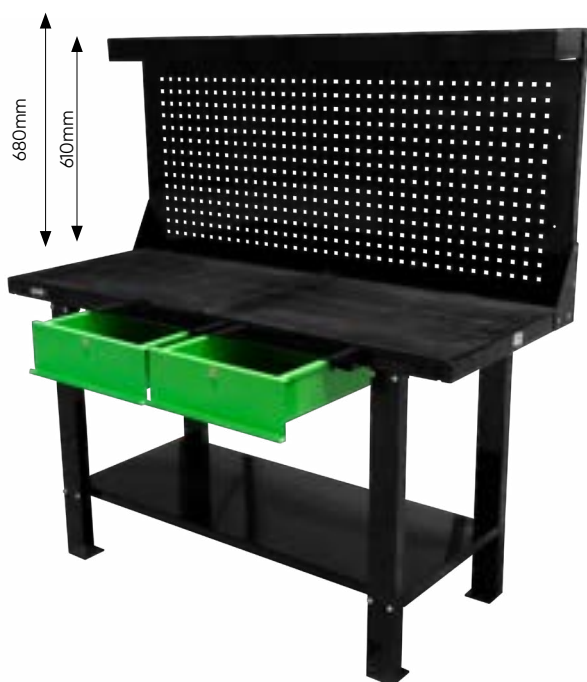

## MESA DE TRABALHO DE 3 GAVETAS

51738

850,00€

81,5

1

5

MEDIDAS GAVETA INTERIOR

142mm

348mm

441mm

50Kg

1t

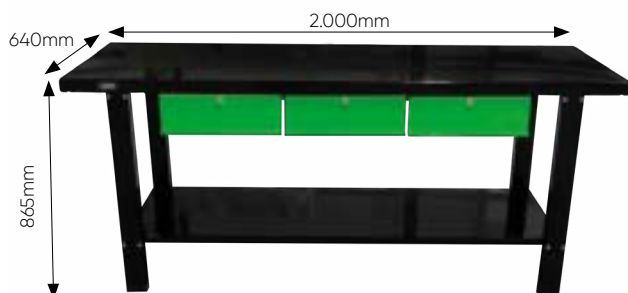

MAT DE BORRACHA

15144

30,00€

2,5

1

## MESA DE TRABALHO DE 2 GAVETAS

51737

699,00€

65,5

1

5

800Kg

- Gaveta:  
Capacidade máxima: 50kg  
Medidas: 348 x 441 x 142mm

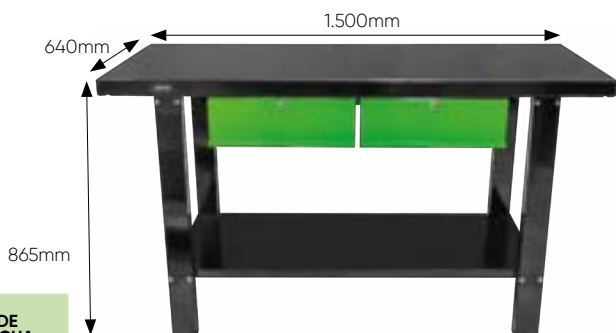

MAT DE BORRACHA

15145

20,45€

1,9

1

## MESA DE TRABALHO DE 1 GAVETA

53674

480,00€

50

1

5

800Kg

- Gaveta:  
Capacidade máxima: 50kg  
Medidas: 348 x 441 x 142mm

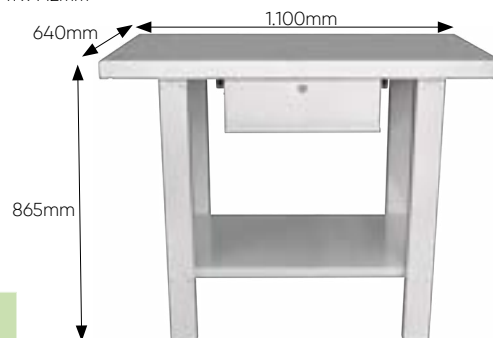

MAT DE BORRACHA

15146

16,15€

1,35

1



# CARRO MODULAR

53672

440,00€



90  
PCS



3 COMPARTIMENTOS  
DESTACÁVEIS E  
SEPARÁVEIS

PODEM SER USADOS  
INDIVIDUALMENTE  
OU JUNTOS

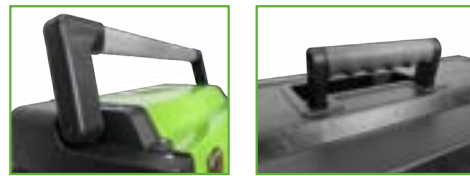

PUNHO SUPERIOR EM CADA MÓDULO PARA  
FACILITAR O TRANSPORTE INDIVIDUAL



FECHADO COM  
CADEADO  
(NÃO INCLUIDO)

3 MÓDULOS INDEPENDENTES  
EQUIPADOS COM:



- Ferramentas 1/4":  
13x cabeças hexagonais 4 - 4,5 - 5 - 5,5 - 6 - 7 - 8 - 9 - 10 - 11 - 12 - 13 - 14 mm 1x Junta universal 1x Manivela (T) 1x Alça de chave de fenda 1x Extensor 50 mm 1x Extensor 100 mm 1x Chave de fenda com imã 1x Chave de catraca de 72 dentes - Ferramentas 1/2":

10x cabeças hexagonais 8 - 10 - 11 - 12 - 13 - 14 - 16 - 17 - 19 - 21 - 22 mm 1x Junta universal 1x Extensor 300 mm 1x Extensor 125 mm 1x Chave de catraca de 72 dentes 1x Conjunto de 8 chaves hexagonais 1,5x8 mm 1x Fita métrica: 3 m 1x Conjunto de 32 bits 1/4"



1x Pinças: 180mm  
1x Alicata universal: 180mm  
1x Alicata de bico longo: 160mm  
1x Alicata universal: 160mm  
1x Chave de fenda Phillips: PH2x125mm  
1x Chave de fenda Phillips: PH1x100 mm  
1x Chave de fenda plana: 6x150mm  
1x Chave de fenda plana: 5x100mm



9x Chaves combinadas: 8, 9, 10, 11, 12, 13, 14, 17, 19mm  
1x Chave inglesa 250 mm  
1x Martelo de impacto 300 g  
1x Alicata 250 mm  
1x Faca 200 mm



Bandeja superior removível



Recipiente para  
ferramentas maiores

14327

177,00€

CONJUNTO DE  
3 MÓDULOS DE  
CARBONO EVA

1

CAIXA DE FERRAMENTAS EM MÓDULOS  
EVA + BANDEJA SUPERIOR REMOVÍVEL

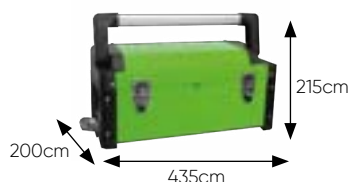

2

2 GAVETAS COM FERRAMENTAS EM  
MÓDULOS EVA

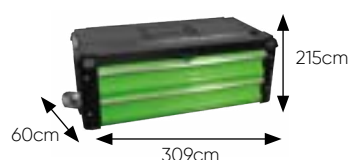

3



IVA não incluído

JBM

www.jbmcamp.com

81

EQUIPAMENTO DE OFICINA



# CONJUNTO DE FERRAMENTAS NA CAIXA DE FERRO DE 64 PEÇAS

53565

16,50 1 24

258,00€



CINCADO

CrV

64 PCS

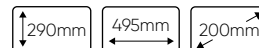

## CONTÉM

	1/2" x18	10, 11, 12, 13, 14, 15, 16, 17, 18, 19, 20, 21, 22, 23, 24, 27, 30, 32mm		1/2" x1	255mm		x3	PH1x100mm, PH2x150mm, PH3x200mm
	x1	1/2"		x1	21mm		x3	SL5x100mm, SL6x150mm, SL8x200mm
	x1	1/2"		x1	457mm		x1	250mm
	1/2" x3	76, 127, 254mm		x18	6, 7, 8, 9, 10, 11, 12, 13, 14, 15, 16, 17, 18, 19, 20, 21, 22, 24mm		x1	180mm
				x9	15, 2, 2.5, 3, 4, 5, 6, 8, 10mm		x1	200mm
							x1	180mm



## CAIXA DE FERRAMENTAS COM 5 GAVETAS

51574

4,3 1 35

58,00€

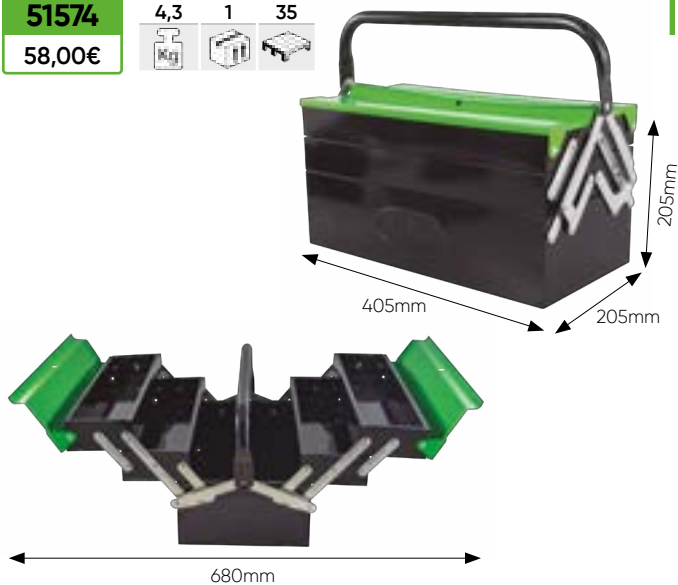

## CAIXA DE FERRAMENTAS XL

53222

6,25 1 25

72,50€



XL



## CAIXA DE FERRAMENTAS COM 3 GAVETAS FRONTAIS + COMPARTIMENTO SUPERIOR

51600

7,69 1 18

109,00€

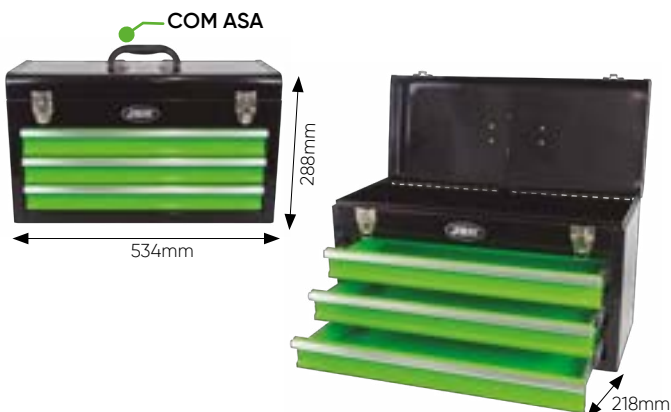

## CAIXA DE FERRAMENTAS COM 6 GAVETAS + COMPARTIMENTO SUPERIOR

51575

19,75 1 9

350,50€



- Gavetas grossas: 570mm ancho  
- Gavetas Meninhas: 180mm ancho





## BANCO HIDRÁULICO

50843

88,00€

5,61 1 42

Ø 295mm

520mm  
135KG

520mm  
390mm



## BANCO DE AÇO

50844

76,00€

3,5 1 52

115 KG



## CAMA PLÁSTICA

52148

89,00€

4,72 1 19

150KG

- Plástico alta densidade.  
- Muito resistente.



## CAMA DOBRÁVEL METÁLICA

50808

84,00€

5,63 1 24

150KG



## CAMA DOBRÁVEL METÁLICA

53211

79,00€

5,4 1 36

900mm  
420mm  
125mm  
150KG



52542

109,00€

12,7 1 23

135KG  
420mm  
105mm  
1.180mm

AÇO E  
ASSENTOS PVC

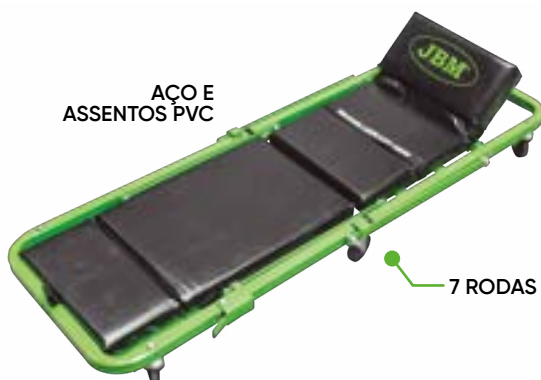

115KG  
650mm  
450mm  
475mm

7 RODAS

## TORNO 150MM RAPIDO

52871

247,50€

24,5

1

28

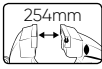

ABERTURA INME-  
DIATA  
+ PARAFUSO RO-  
TATIVO



6"

## TORNO DE BANCO PARAFUSO ROTATIVO

53031

68,00€

5,78

2

162



4"

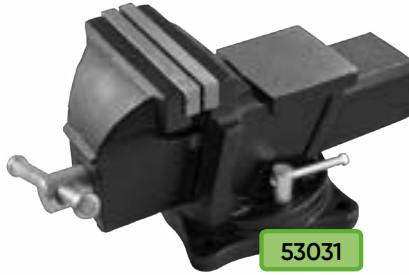
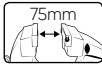

53031

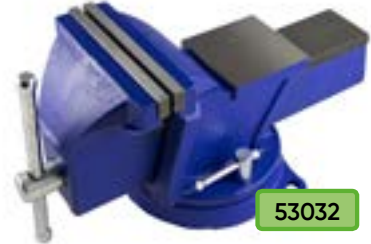

53032

53032

129,00€

13,71

1

60



6"

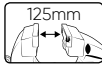

## TORNO DE BANCO

51570

182,50€

15,02

1

48



4"

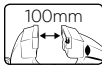

## TORNO DE BANCO

52869

51,50€

4,96

2

168



4"

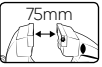

52870

99,00€

12,12

1

72



6"

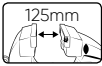

## BIGORNAS PROFESIONALES

52308

630,00€

50

1

20



AÇO

52309

995,00€

100

1

9





CHAVES DE IMPACTO



86

CATRACA/ APARAFUSADOR DE IMPACTO



89

BROCA DE IMPACTO / MARTELO GIRATÓRIO

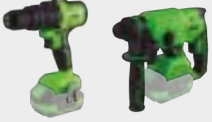

90

PULIDOR / MOEDOR DE ÂNGULO



92

SERRAS



93

LIMPADOR DE VÁCUO / INFLADOR

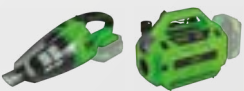

96

VENTILADOR / PULVERIZADOR INDUSTRIAL



100

SERRA ELÉTRICA / TESOURAS



101

FAROL DE TRABALHO LED

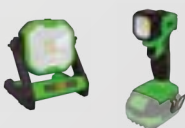

103

BATERÍAS / CARREGADORES



105

ACESSÓRIOS



106

MOCHILAS



110



# FERRAMENTA A BATERIAS MOTOR BRUSHLESS



**SERIE327**

# Ferramentas eléctricas sem fio, para uso mais confortável e ilimitado

Com motor **BRUSHLESS**: maior eficiência, vida útil mais longa, mais velocidade e menos ruído.

CE RoHS TÜV GS

## CHAVE DE IMPACTO COM MOTOR SEM ESCOVAS 1/2"

1000Nm

60018

2,85

6

72

305,50€



Bateria não incluída.

Esta ferramenta destina-se a **aparafusar/desaparafusar** elementos de **fixação**.



**BRUSHLESS MOTOR**  
**20V**  
**1000 Nm**  
**1/2"**  
**0-2300IPM**  
**LED**

0-900 RPM  
 0-1600 RPM  
 0-1900 RPM

EIXO DE SAÍDA

**14675** 17,00€

COBERTURA

**14677** 9,00€

**14679** 9,50€

PLACA DE CIRCUITO IMPRESSO + ESTATOR

**14648** 105,15€

BLOCO DE CHOQUE

**14676** 36,50€

PLACA DE CIRCUITO IMPRESSO

**14678** 86,00€

ROTOR

**14769** 37,75€

5 ENGRENAGENS DIFERENTES



Você quer ver como funciona?



- Ele inclui:  
Alça.  
Interruptor do sentido de rotação para frente/para trás.  
Gatilho.  
Iluminação de fundo LED.  
Ganchô para um cinto.





## CHAVE DE IMPACTO COM MOTOR SEM ESCOVAS 1/2"

**1200Nm**

**60036**

**305,50€**

3,20

4

144



Bateria não incluída.

Esta ferramenta destina-se a **aparafusar/desaparafusar** elementos de fixação.



**BRUSHLESS MOTOR**

**20V**

**1200 Nm**

**1/2"**

0-2300IPM



0-900 RPM



0-1600 RPM



0-1900 RPM

**LED**

EIXO DE SAÍDA

**14675** 17,00€

**14677** 9,00€

COBERTURA

**14679** 9,50€

PLACA DE CIRCUITO IMPRESSO + ESTATOR

**14648** 105,15€

BLOCO DE CHOQUE

**14676** 36,50€

PLACA DE CIRCUITO IMPRESSO

**14678** 86,00€

ROTOR

**14769** 37,75€

5 ENGRENAGENS DIFERENTES



Você quer ver como funciona?



- Ele inclui:  
Alça.  
Interruptor do sentido de rotação para frente/para trás.  
Gatilho.  
Iluminação de fundo LED.  
Gancho para um cinto.



Use-os com baterias JBM: uma única bateria adequada para todas as ferramentas

BATERIA DE LÍTIO

2.0Ah



**60012**

4.0Ah



**60013**

6.0Ah



**60015**

CARREGADOR



**4A**  
**60016**



**CARREGADOR RÁPIDO**  
**6A**  
**60017**



IMPACTO



# CHAVE DE IMPACTO COM MOTOR SEM ESCOVAS 1/2 "

**1550Nm**

**60034** 3,20 4 144  
**320,00€**

Bateria não incluída.  
Esta ferramenta destina-se a **aparafusar/desaparafusar** elementos de **fixação**.

**BRUSHLESS MOTOR**

**20V** 1550 Nm **3/4"**

① 0-900 RPM    ② 0-1600 RPM    ③ 0-1900 RPM

EIXO DE SAÍDA	<b>14675</b> 17,00€	<b>14677</b> 9,00€	COBERTURA	<b>14679</b> 9,50€
BLOCO DE CHOQUE	<b>14676</b> 36,50€	<b>14678</b> 86,00€	ROTOR	<b>14769</b> 37,75€
			PLACA DE CIRCUITO IMPRESSO + ESTATOR	<b>14648</b> 105,15€

5 ENGRENAGENS DIFERENTES



Você quer ver como funciona?



- Ele inclui:
- Alça.
- Interruptor do sentido de rotação para frente/para trás.
- Gatilho.
- Iluminação de fundo LED.
- Gancho para um cinto.





## CATRACA ELÉCTRICA DE 1/2" BRUSHLESS

**60024**  
189,50€

1,90 5 150

ESTA REFERÊNCIA INCLUI  
X1 BATERIA E X1 CARREGADOR

Esta ferramenta foi projetada para **apertar/desapertar os prendedores em locais de difícil acesso.**



12V

80 Nm

1/2"

0-175 RPM

LED



2.0AH  
60min +/-10min

CE RoHS

INCLUI:

CARREGADOR DE 12 V  
PARA REF. 60026

**60025**  
28,50€

0,30 5 4



BATERIA DE ÍON DE LÍTIO 2.0  
A\*h SAMSUNG  
PARA REF. 60024

**60026**  
33,00€

0,20 8 5

## APARAFUSADOR DE IMPACTO SEM ESCOVAS

**60005**  
132,00€

1,40 4 180

Bateria não incluída.

Esta ferramenta foi projetada para **apertar rapidamente parafusos e porcas** e é especialmente útil ao trabalhar com **parafusos longos e materiais duros.**

O driver está equipado com **iluminação LED** da área de trabalho para um trabalho mais confortável e preciso, um **mandril de troca rápida hexagonal de 1/4"** de polegada para rápida instalação e remoção do bico, além de um **gatilho com uma função de trava** para impedir o início acidental da ferramenta.



20V

200 Nm

LED

0-2800 RPM



1/4"

- Completude:  
1 pc gancho de cinto.  
Iluminação de fundo LED integrada.  
Controlador de velocidade.  
Alça suave.  
Redutor de engrenagens de metal.



BLOCO DE CHOQUE  
**14637** 15,50€

PLACA DE CIRCUITO IMPRESSO  
**14642** 83,00€

EIXO T  
**14638** 7,00€

PLACA DE CIRCUITO IMPRESSO + ESTATOR  
**14765** 96,50€

INTERRUPTOR  
**14640** 8,00€

COBERTURA  
**15254** 12,50€

ROTOR  
**14641** 18,50€

CONSUMÍVEIS

**53857**



**53858**



página 108



Use-os com baterias JBM: uma única bateria adequada para todas as ferramentas

BATERIA DE LÍTIO

2.0Ah



**60012**

4.0Ah



**60013**

6.0Ah



**60015**

CARREGADOR



4A  
**60016**



CARREGADOR RÁPIDO  
6A  
**60017**

## BROCA DE IMPACTO DE DUAS VELOCIDADES COM MOTOR SEM ESCOVAS

60006

181,50€

1,65

4

56



Bateria não incluída.

Esta ferramenta foi projetada para **perfurar madeira e metal**, operações de percussão principalmente em **alvenaria, concreto, pedra e tijolo vermelho**, bem como para **apertar/desapertar e desaparafusar parafusos e porcas**.

A ferramenta possui um seletor para selecionar o modo de operação (**furação, furação com parafusos de impacto e aperto**), um acoplamento com **23 valores predefinidos do torque de aperto**, um controlador de velocidade e um **mandril de 1/2" sem chave** para instalação/remoção rápida e conveniente da ferramenta.



- Completez:  
1 pç. alça adicional.  
1 pç. gancho de cinto.  
23 ajustes de torque de aperto.  
Iluminação de fundo LED integrada.  
Interruptor de 2 velocidades.  
Alça suave.

CARTUCHO DE FURO

14643 24,50€

TROCAR

14644 8,00€

ROTOR

14645 44,50€

PLACA DE CIRCUITO IMPRESSO + ESTATOR

14646 109,50€

PEGA ADICIONAL

14954 14,50€

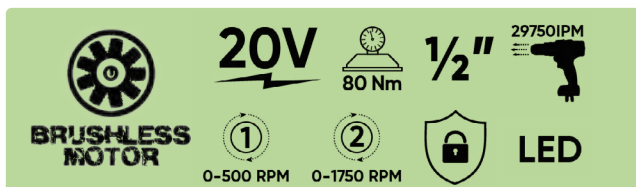

DIÂMETRO DO MANDRIL: 2-13MM (1/2")



ALÇA ADICIONAL



### CONSUMÍVEIS

página 106-108

KIT DE BROCAS PARA CONCRETO

53861



3-10MM  
8 PCS

53860



4-10MM  
5 PCS

ACO YG8



KIT DE BROCAS ESPIRAIS HSS 4341

53852



1-10MM  
170 PCS

53856



1-13MM  
25 PCS

KIT S2 DE BOCAS DE MUDANÇA RÁPIDA REVESTIMENTO PRETO

53857



49 PCS

53858



21 PCS

CONJUNTO DE SERRAS ANULARES BIMETÁLICAS

53859



8 PCS

HSS M42 4-6TPI

## APLAINADORA SEM ESCOVA

60020

175,00€

3,15

4

72



Bateria não incluída.

Esta ferramenta foi projetada para **trabalhar com madeira**. Permite obter uma **superfície lisa da madeira e fazer uma forma cônica**, se necessário.

A plaina é equipada com uma **base de liga de alumínio** para posicionamento preciso, um **sistema de coleta de poeira** para coletar poeira do processamento de madeira e um **botão de trava de gatilho** para impedir o início acidental da ferramenta.

- Completez:  
1 pç. botão de ajuste da profundidade de chanframento.  
1 pç. guia paralelo.  
3 pç. botões de ajuste.  
1 pç. chave.



BRUSHLESS MOTOR

20V



16000 RPM

10,5mm

82mm  
0-2mm

- Características:  
Botão de ajuste de profundidade de amostragem  
Base de liga de alumínio  
Botão de bloqueio do botão de início  
Sistema de coleta de poeira  
Alça suave

ESTATOR

14936 27,50€

CINTO

14684 3,00€

GUIA DE ENCAIXE

14964 8,00€

INTERRUPTOR

14685 5,00€

GUIA PARALELO

14965 8,50€

PLACA DE CIRCUITO IMPRESSO

14686 72,50€

ROTOR

14687 35,00€





# MARTELO GIRATÓRIO COM MOTOR SEM ESCOVAS

60023

3,10 6 120

212,00€



Bateria não incluída.

Essa ferramenta foi projetada para **perfuração e trituração de concreto e tijolo**, bem como para perfuração convencional de outros materiais, como **aço, madeira, metal, cerâmica e plástico**.

- Tipo de mandril: **SDS**.



**BRUSHLESS MOTOR**

**20V**

4750BPM

2.2 J



1350 RPM

**WOOD**  
28mm

**CONCRETE**  
22mm

**STEEL**  
13mm



- Completude:  
1 pç. tampa protetora contra poeira.  
1 pç. medidor de profundidade.  
1 pç. alça adicional.  
1 pç. cinzel pontiagudo.  
1 pç. cinzel plano.  
Brocas SDS: Ø8/10/12 x 150 mm.



ALAVANCA DE POTÊNCIA

**14693 3,50€**

ROLAMENTO DA ALAVANCA DE PÊNDULO

**14694 11,50€**

MARTELO DE CHOQUE

**14695 4,00€**

CILINDRO PNEUMÁTICO

**14696 18,00€**

**14697 8,00€**

ANEL DE VEDAÇÃO

**14698 1,00€**

ROTOR

**14699 30,00€**

ENGRENAGEM No. 61

**14700 2,50€**

PLACA DE CIRCUITO IMPRESSO

**14702 91,50€**

ENGRENAGEM No. 67

**14701 2,50€**

TAMPA DE PÓ

**14967 5,50€**

MEDIDOR DE PROFUNDIDADE

**14968 6,00€**

PEGA ADICIONAL

**14969 9,00€**

## CONSUMÍVEIS

página 108

14837



14838



14839



14840



14842



14841



53850



# LIXADEIRA SEM ESCOVA

60033

1

103,50€



Bateria não incluída.

Esta ferramenta foi projetada para **lixa madeira, ferro, plástico e materiais semelhantes**, usando lixa adequada. Esta lixadeira foi projetada com três velocidades, uma alça confortável e um saco de pó embutido.



**20V**

6000 RPM  
8000 RPM  
10000 RPM

0°C  
45°C



x3 SPEED

150mm

SACO DE PÓ  
**15530 7,50€**

SUPORE DE SACO DE VACUO  
**15531 5,00€**

ESTATOR + PP + SENSOR  
**15532 98,00€**

ROLAMENTO  
**15533 4,50€**

ROLAMENTO  
**15534 4,50€**

SELA DE ROLAMENTO  
**15535 3,50€**

ROLAMENTO  
**15536 14,50€**

UNIDADE DE FREIO DE BORRACHA  
**15537 6,00€**

PLACA DE BASE  
**15538 17,00€**

Use-os com baterias JBM: uma única bateria adequada para todas as ferramentas

### BATERIA DE LITIO

2.0Ah



**60012**

4.0Ah



**60013**

6.0Ah



**60015**

### CARREGADOR



**4A 60016**

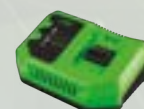

**CARREGADOR RÁPIDO 6A 60017**







LIXAR/POLIR



### POLIDOR COM MOTOR SEM ESCOVAS

**60009** 2,22 4 80 Bateria não incluída.  
**168,00€**

A ferramenta foi projetada para processamento limpo, como **polir e arredondar cantos e arestas**, além de obter **superfícies lisas** com um disco e uma almofada de polimento.

O dispositivo possui um interruptor de velocidade de **9 velocidades**, além de um **gatilho com uma função de travamento** durante a operação ou travamento durante o armazenamento para impedir a partida acidental.

- Complete: 1 pç. alça adicional em forma de D. 1 pç. chave sextavada. 1 pç. almofada de polimento. Interruptor de 9 velocidades: 800, 1000, 1200, 1400, 1600, 1800, 2000, 2200, 2400 rpm. Alça suave. Interruptor de segurança. Botão de bloqueio do eixo.

**BRUSHLESS MOTOR** **20V** 800-2400 RPM **M14**  
**VELOCIDADE AJUSTÁVEL** **Ø 180mm**

ROTOR <b>14658</b> 45,00€	PLACA DE CIRCUITO IMPRESSO + ESTATOR <b>14660</b> 83,00€	ENGENRAGEM #24 <b>14662</b> 2,50€	RODA DE POLIMENTO <b>14958</b> 22,00€
INTERRUPTOR <b>14659</b> 5,00€	ENGENRAGEM <b>14661</b> 9,00€	ENGENRAGEM #26 <b>14663</b> 2,50€	ALÇA EM D ADICIONAL <b>14959</b> 10,00€



### MOEDOR DE ÂNGULO COM MOTOR SEM ESCOVAS

Diâmetro do disco: **115 mm (4-1/2")** Diâmetro do disco: **125 mm**

<b>60008</b> 1,85 6 168 <b>140,50€</b>	<b>60028</b> 1,95 6 162 <b>141,50€</b>
---	---

- A esmerilhadeira foi projetada para **esmerilar, limpar e cortar vários materiais**.  
 - Tamanho da rosca: **M14**.

**BRUSHLESS MOTOR** **20V** 8000 RPM **M14**

Bateria não incluída. Lâmina não incluída.



- Complete: 1 pç Tampa do rebolo. 1 pç Alça adicional. 1 pç Chave.

ROTOR <b>14652</b> 45,00€	ENGENRAGEM #29 <b>14767</b> 3,00€
INTERRUPTOR <b>14653</b> 5,00€	PEGA ADICIONAL <b>14956</b> 8,00€
PLACA DE CIRCUITO IMPRESSO + ESTATOR <b>14654</b> 99,50€	CAIXA DE PROTEÇÃO 115MM <b>14957</b> 7,50€
ENGENRAGEM #13 <b>14655</b> 6,50€	CAIXA DE PROTEÇÃO 125MM <b>14808</b> 4,00€
PLACA DE FIXAÇÃO <b>14656</b> 5,00€	PORCA DE REMOÇÃO RÁPIDA M14 <b>15014</b> 20,00€
ENGENRAGEM #23 <b>14657</b> 5,00€	
ENGENRAGEM #22 <b>14766</b> 3,50€	

CONSUMÍVEIS

página 109

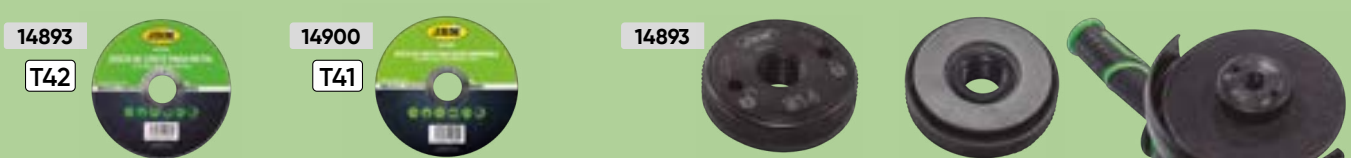



## SERRA DE RECIPROCITAÇÃO COM MOTOR SEM ESCOVAS

60019

3,45

4

96

179,50€



Bateria não incluída.

Esta ferramenta foi projetada para **cortar uma grande variedade de materiais e é amplamente utilizada**. O design permite a **substituição rápida e conveniente da lâmina de serra** devido ao suporte de aperto rápido e é caracterizado por uma velocidade de corte ajustável, dependendo da operação a ser executada.



- Completez:  
1 pç. lâmina de madeira.  
1 pç. lâmina de metal.



BOTÃO

14680 17,00€

PLACA DE CIRCUITO IMPRESSO

14683 86,00€

PLACA DE CIRCUITO IMPRESSO + ESTATOR

14681 107,50€

ROTOR

14770 40,00€

INTERRUPTOR

14682 9,00€

CONSUMÍVEIS PARA REF. 60019

página 109

14995



14994



CONSUMÍVEIS PARA REF. 60010

página 109

14993



14991



## SERRA DE VAIVÉM COM MOTOR SEM ESCOVAS

60010

2,45

4

144

Bateria não incluída.

169,50€



Esta ferramenta foi projetada para **serrar tais materiais como madeira, aço, plástico e metal**.

A serra de vaivém está equipada com um **mecanismo pendular de 4 posições**: 3 posições para corte orbital e 1 posição para corte direto, o que permite escolher a velocidade de corte ideal da lâmina para a dureza do material



20V

WOOD  
Max: 135mm

STEEL  
Max: 8mm

26mm

2600 SPM LED



PLACA DE CIRCUITO IMPRESSO + ESTATOR

14664 95,50€

INTERRUPTOR

14665 9,00€

PLACA DE CIRCUITO IMPRESSO

14666 78,00€

ENGRENAGEM

14667 9,00€

BOTÃO

14668 8,00€

COMPONENTES DO ROLO

14670 5,00€

ROTOR

14768 28,00€

TUBO DE PÓ

14960 7,50€

GUIA PARALELO

14961 7,50€

- Contém:  
1 pç: disco de madeira.  
1 pç: Guia de borda.  
1 pç: tubo de poeira.

- Características:  
Engrenagem com engrenagens de metal.  
Alça suave.  
Controle de velocidade.  
Mecanismo pendular de 4 posições.  
Base de alumínio.  
Iluminação LED integrada.  
Botão de bloqueio do gatilho.

Use-os com baterias JBM: uma única bateria adequada para todas as ferramentas

BATERIA DE LITIO

2.0Ah



60012

4.0Ah



60013

6.0Ah



60015

CARREGADOR

4A



60016



CARREGADOR RÁPIDO

6A

60017



## SERRA CIRCULAR COM A LOCALIZAÇÃO TRASEIRA DO MOTOR SEM ESCOVAS

60011

175,00€

2,55

4

128



Bateria não incluída.

Esta ferramenta foi projetada para **serrar madeira**. A serra circular com um diâmetro de **115 mm com 24 dentes** é ideal para **cortes longitudinais/transversais** diretos e para serrar até **45° de tábuas e painéis de madeira**. A serra também possui um **botão de trava de gatilho** para impedir o arranque acidental da ferramenta e uma **cobertura de alumínio**.



- Completude:  
1 pc: disco TCT de 115mm 24T.  
1 pc.: Guia para borda.  
1 pc.: tubo de poeira.  
1 pc: chave Allen.

- Características:  
Mecanismo de bloqueio.  
Alça suave.  
Caixa superior e inferior de alumínio.  
Sistema de coleta de poeira.

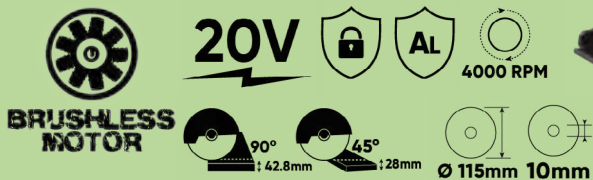

ROTOR

14671 44,00€

PLACA DE CIRCUITO IMPRESSO + ESTATOR

14674 72,50€

GUIA PARALELO

14963 7,50€

INTERRUPTOR

14672 5,00€

TUBO DE PÓ

14962 6,50€

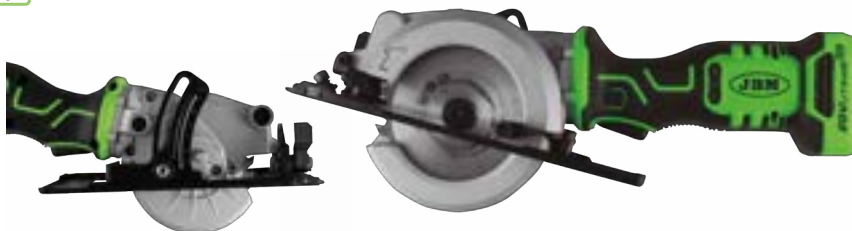

CONSUMÍVEIS PARA REF. 60011

página 109

Serra circular 24 dentes 115mm

14989 14986



CONSUMÍVEIS PARA REF. 60007

página 109

Serra circular 24 dentes 165mm

14988 14985



## SERRA CIRCULAR COM MOTOR SEM ESCOVAS

60007

170,00€

3,2

4

56



Bateria não incluída.

Esta ferramenta foi projetada para **serrar madeira**. Uma serra circular de **165mm de diâmetro e 24 dentes** é ideal para **cortes longitudinais/transversais retos**, bem como para serrar tábuas e painéis de madeira num **ângulo de até 45°**.

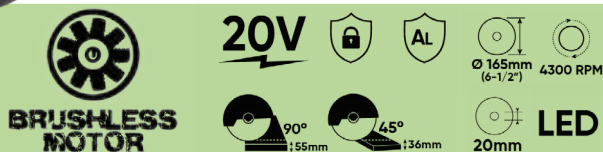

- Características:  
Mecanismo de bloqueio.  
Alça suave.  
Caixa superior e inferior de alumínio.  
Iluminação de LED embutida.

INTERRUPTOR

14647 3,00€

ENGRANAGEM

14650 5,00€

GUIA PARALELO

14955 7,50€

ROTOR

14649 50,00€

PLACA DE CIRCUITO IMPRESSO + ESTATOR

14651 86,00€

- Completude:  
1 pc: disco TCT de 165 mm 24T.  
1 pc.: Guia para borda.  
1 pc: chave Allen.

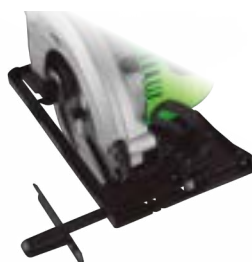





## SERRA COM MOTOR SEM ESCOVAS

**60022** 11,40 1 9  
**662,50€** Bateria não incluída.

Esta ferramenta foi projetada para **serrar madeira e materiais similares**. A ferramenta permite executar cortes oblíquos quando é necessário um corte inclinado ao longo da superfície da peça de trabalho, cortes num ângulo usados, como regra, para conexões que formam um ângulo de 90°, bem como cortes combinados quando é necessário um corte angular e um corte ao longo da borda e da superfície frontal da peça de trabalho.

A serra esquadria está equipada com um **saco de pó**, um **apontador laser**, uma **chave** para remover / instalar a lâmina e um **torno para prender a peça de trabalho**. Além disso, por razões de segurança, é fornecido um **bloqueio do botão** de início para impedir o início acidental da ferramenta.

**BRUSHLESS MOTOR** **20V** **LASER** **3500 RPM**

**30A** Ø185mm 25.4mm

90° 90° 45° 90°  
 205mm ; 50mm 152mm ; 50mm

90° 45° 45°  
 205mm ; 38mm 152mm ; 38mm

MOTOR  
**14691** 166,50€

INTERRUPTOR  
**14692** 5,50€

SACO DE PÓ  
**14966** 7,50€



Completude:  
 1 pç. serra circular de 40 dentes  
 1 pç. braçadeira  
 1 pç. chave de lâmina  
 1 pç. saco de pó



CONSUMÍVEIS PARA REF. 60022

página 109

Serra circular 40 dentes 185mm

**14990** **14987**



- Material: lâminas YG8, base de carboneto de tungstênio.



Use-os com baterias JBM: uma única bateria adequada para todas as ferramentas

BATERIA DE LITIO



CARREGADOR



## LIMPADOR DE VÁCUO PORTÁTIL

**60001** 1,70 4 48 Bateria não incluída.  
**90,00€**

Este aspirador elétrico **sem fio** foi projetado para aspirar qualquer material que não seja prejudicial à saúde.

A **bateria recarregável** torna-o **facilmente portátil** e os diferentes acessórios permitem realizar diferentes tipos de limpeza em vários locais.



- Ele inclui:  
 1 Bocal de fenda.  
 1 Tubo de extensão.  
 1 Bocal de escova.  
 1 Bocal de chão.

**20V** 3.8 kPa 500mL

ELEMENTO DE FILTRO	TUBO DE EXTENSÃO	BOCAL DE CHÃO
<b>14628</b> 2,50€	<b>14950</b> 6,50€	<b>14952</b> 19,00€
INTERRUPTOR	BOCAL DE FENDA	ESCOVA
<b>14629</b> 4,00€	<b>14951</b> 9,50€	<b>14953</b> 8,50€
MOTOR		
<b>14630</b> 22,00€		

## INFLADOR ELÉTRICO

Bateria não incluída. **60003** 1,52 4 104 **109,50€**

Este inflador permite inflar rodas de carros e motos, bolas, lanchas infláveis, colchões infláveis, etc.

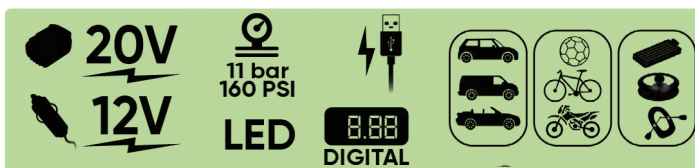

- Ele inclui:



MÓDULO DE BOMBA	INTERRUPTOR DO MODO DE OPERAÇÃO
<b>14634</b> 36,50€	<b>14631</b> 3,50€
VENTILADOR	INTERRUPTOR DE LUZ LED
<b>14635</b> 10,00€	<b>14632</b> 3,50€

MANGA DE ALTA PRESSÃO **15151** 10,50€



Comprimento da mangueira de alta pressão: **760 mm**  
 Comprimento da mangueira de alta capacidade: **460 mm**

Use-os com baterias JBM: uma única bateria adequada para todas as ferramentas

BATERIA DE LÍTIO



CARREGADOR





## FERRAMENTA MULTI-FUNCIONAL DE OSCILAÇÃO SEM FIO

60041

1,12

77,00€



Bateria não incluída.



ALAVANCA DE BLOQUEIO

15320

1,00€

TAMPA DO MEIO

15322

3,50€

ROLAMENTO DE BOLA 625

15321

3,00€

MOTOR

15323

24,00€

REGULADOR DE VELOCIDADE

15324

18,00€

JUNTA DE VEDAÇÃO

15326

1,00€

PAINEL DE JUNÇÃO

15325

3,50€

MANGA AUXILIAR

15327

5,50€



Uma variedade de acessórios pode ser usada com a ferramenta oscilante multifuncional para se adequar a uma ampla variedade de tarefas. A ferramenta é especialmente útil para limpeza, lixamento e serragem profunda em espaços apertados.

**20V**  
BRUSHLESS MOTOR



5000-19000 OPM

90x90x90mm

72x52mm

96x32,5mm

x6 SPEED

CONSUMÍVEI

página 108

53999

54000

54002

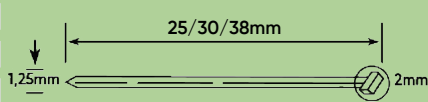

54008

54010

54011

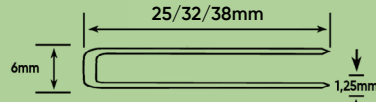

## FERRAMENTA/GRAMPEADOR ELÉTRICO

60037

2,9

221,50€



Bateria não incluída.

**20V 2000Ah**

MAX 100 grapas por minuto staples per minute

60 grapas por minuto staples per minute

Capacidade máxima del cargador Max. magazine capacity **100** Clavos/grapas Nails/staples



A ferramenta é projetada para prender papelão, materiais isolantes, tecido, folha, couro e materiais semelhantes à madeira ou outras superfícies semelhantes por meio de um martelo de alta potência usando ar comprimido.

A ferramenta é equipada com iluminação LED para indicar o status e melhorar a visibilidade durante a operação, um botão seletor de acionamento para selecionar entre os modos de acionamento único e de contato para uma operação mais precisa ou mais rápida, e uma roda de ajuste de profundidade para selecionar a profundidade desejada de pregos/grampos. Além disso, a ferramenta é

equipada com um gancho para cinto e uma alça acolchoada.

Além disso, a ferramenta é equipada com um **pino de contato de segurança**, que deve ser pressionado contra a peça de trabalho antes que o prego/grampo seja puxado no modo de acionamento único, ou seja, o pino atua como um mecanismo de segurança para evitar o início acidental da ferramenta.



Máx. comprimento de prego	50 mm
pregos sem tampa de tamanho 18	
Largura máxima da secção transversal do prego	1,25 mm
Espessura máxima da secção transversal do prego	1,05 mm

Longitud máxima de las grapas	40 mm
grampos do tipo leve com parte superior estreito de tamanho 18	
Largura máxima da secção transversal dos agrafos	1,2 mm
Espessura máxima da secção transversal dos agrafos	1 mm
Máx. tamanho da parte superior do grampo	6 mm

MARTELO EM CONJUNTO

15276 45,50€

MOTOR

15279 68,50€

TAMPA DE VEDAÇÃO EM CONJUNTO

15277 9,00€

CHAVE

15280 91,00€

CARCAÇA DE SEGURANÇA

15278 3,50€

Use-os com baterias JBM: uma única bateria adequada para todas as ferramentas

BATERIA DE LITIO

2.0Ah



60012

4.0Ah



60013

6.0Ah



60015

CARREGADOR



4A 60016



CARREGADOR RÁPIDO 6A 60017

## SERINGA ELÉTRICA PARA LUBRIFICAÇÃO

60038

255,00€

3,35



Bateria não incluída.

Esta ferramenta é uma **pistola de graxa**. Alimentada por bateria, a ferramenta é fácil de usar e transportar.

A ferramenta é equipada com iluminação LED para melhor visibilidade da área de trabalho, válvula de segurança de saída de ar para proteção contra sobrepessão e entupimento, alça macia para fácil operação e botão de bloqueio para evitar ativação acidental. O fluxo de graxa é regulado por meio da roda de controle de velocidade (**8 posições**).



20V

9000PSI  
620BAR

Volumen/caudal  
Volume/flow rate  
200g/min

Capacidad de graxa en cartucho hasta  
Grease cartridge capacity up to  
420g

Capacidad de graxa a granel  
Bulk grease capacity  
600g

Tipo de graxa hasta  
Grease type up to  
NLGI #2

760mm

8  
Niveles de caudal  
Flow level



BOMBA

15380 168,50€

PLACA DE CIRCUITO IMPRESSO

15382 42,00€

MICRO GATILHO

15381 5,50€

MANGUEIRA FLEXÍVEL

15440 33,00€

## SERINGA ELÉTRICA PARA COSTURAS

Bateria não incluída.

1,56

4

60032

122,50€

Esta ferramenta foi projetada para **preencher qualquer fenda ou rachadura numa ampla variedade de materiais**, como metal, vidro, madeira e cerâmica.

A ferramenta é equipada com **luz de trabalho LED** para fácil operação em condições de baixa visibilidade, além de **controle de velocidade** e sistema de **trava de gatilho**. Além disso, o design inclui um mecanismo de **proteção contra quedas**. Depois de liberar o gatilho 0,2-0,3 s, a cola continua a fluir por 0,8 s.



20V

2500 Nm

300ml

0,5-8mm/s

LED

VELOCIDADE AJUSTÁVEL

MECANISMO ANTIGOTEO  
ANTI-DROP MECHANISM



MOTOR

15126 19,50€

PLACA DE CIRCUITO IMPRESSO

15127 29,00€

Use-os com baterias JBM: uma única bateria adequada para todas as ferramentas

BATERIA DE LÍTIO

2.0Ah



60012

4.0Ah



60013

6.0Ah



60015

CARREGADOR



4A  
60016



CARREGADOR RÁPIDO  
6A  
60017



## SERINGA ELÉTRICA PARA COSTURAS

60042

1,6

Bateria não incluída.

105,50€



Esta ferramenta foi projetada para **preencher qualquer fenda ou rachadura numa ampla variedade de materiais**, como metal, vidro, madeira e cerâmica. A ferramenta é equipada com **luz de trabalho LED** para fácil operação em condições de baixa visibilidade, além de **controle de velocidade** e sistema de **trava de gatilho**. Além disso, o design inclui um mecanismo de **proteção contra quedas**. Depois de liberar o gatilho 0,2-0,3 s, a cola continua a fluir por 0,8 s.



20V

15A

550°C  
1022°F

Max.  
200L/min.

0.6kg

Ø 34mm

PA6-GF30+TPE



## PISTOLA DE PULVERIZAÇÃO SEM FIO

60043

1,3

Esta ferramenta foi projetada para pulverizar tinta para superfícies e em ambientes fechados e ao ar livre.

122,50€



Bateria não incluída.

1,3 kg

900ML

20V 243W

5m

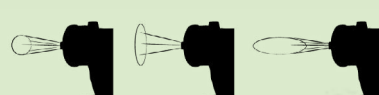

Ø 2,5mm

60 DIN/s

700ml/min PA6 y PP



O bico pode ser ajustado para um dos três modos de pulverização: circular, horizontal ou vertical.



Use-os com baterias JBM: uma única bateria adequada para todas as ferramentas

BATERIA DE LITIO

2.0Ah



60012

4.0Ah



60013

6.0Ah



60015

CARREGADOR



4A  
60016



CARREGADOR RÁPIDO  
6A  
60017

# MÁQUINA DE LAVAR ELÉTRICA SEM ESCOVAS

A lavadora de alta pressão com motor sem escovas é projetada para a limpeza de veículos, equipamentos, ferramentas, móveis de jardim, etc.

60039

264,50€

4,3

Bateria não incluída.



319-507 PSI  
22-25 BAR

20V

2.0-2.4L/min

2.0 kg



Inclui um bico ajustável que permite selecionar o fluxo de água apropriado dependendo da sujeira a ser removida e da superfície a ser limpa.



TAMPA DE ROSCA PARA VÁLVULA DE ABASTECIMENTO DE ÁGUA

15481 4,50€

CONECTOR DA TUBULAÇÃO DE ABASTECIMENTO DE ÁGUA

15484 5,50€

CONJUNTO DE 6 VÁLVULAS UNIDIRECIONAIS

15487 58,50€

AGULHA DA VÁLVULA DE RETENÇÃO PARA TUBULAÇÃO DE ENTRADA E SAÍDA

15490 4,00€

ANEL SUPERIOR DA MOLA PARA A VÁLVULA DE ABASTECIMENTO DE ÁGUA

15482 4,00€

ANEL SELADO PARA O INTERRUPTOR

15485 4,00€

ANEL DE VEDAÇÃO PARA TUBOS DE ENTRADA E SAÍDA

15488 4,00€

MOLA DA VÁLVULA DE ALÍVIO DE PRESSÃO

15491 4,00€

MOLA DA VÁLVULA DE ABASTECIMENTO DE ÁGUA

15483 4,00€

INTERRUPTOR PARA O PULVERIZADOR DA LAVAGEM

15486 9,00€

TUBULAÇÃO DE ENTRADA E SAÍDA

15489 10,50€

COTOVELO DA TUBULAÇÃO

15492 5,00€

MOLA

15493 4,50€



# PULVERIZADOR ELÉTRICO INDUSTRIAL DE MOCHILA COM TANQUE DE 15 L

60027

121,50€

5,65

6

15

Bateria não incluída.

Suporte de pulverização telescópico.

A ferramenta é adequada para a desinfecção de casas particulares, locais públicos, fazendas de gado, jardins, etc., e permite destruir todas as partículas perigosas, impedir a sua propagação e impedir a reprodução de insetos e o desenvolvimento de doenças.

Manivela inteligente com intertravamento para operação contínua.

Também estão incluídos no pacote 4 bicos com capacidade e fluxo específicos, dependendo dos requisitos: 1 bico cônico oco, 1 bico cônico duplo oco, 1 bico ajustável com 4 orifícios, 1 bico do ventilador.

Tampa de enchimento com trava

Alça para fácil transporte

Suporte para instalação da prateleira



Almofada RESPIRÁVEL E ERGONÔMICA para as costas para evitar a sensação de peso após uso prolongado e para facilitar a separação e distribuição do suor.



20V

15L

0.3-0.45 Mpa



1-1.2m

40 - 80cm



- Ele inclui:



Use-os com baterias JBM: uma única bateria adequada para todas as ferramentas

BATERIA DE LÍTIO

2.0Ah



60012

4.0Ah



60013

6.0Ah



60015

CARREGADOR



4A 60016



CARREGADOR RÁPIDO 6A 60017





## SERRA ELÉTRICA COM MOTOR SEM ESCOVA

**60029**  
239,50€

3,2

1



Bateria não incluída.

Esta ferramenta florestal foi projetada para tarefas como **derrubar, desgalhar, serrar e cortar árvores**. A ferramenta está equipada com uma **alça para ajustar a tensão da barra guia e da corrente**, um **freio da corrente para parar a corrente ao recuar** e um **prendedor da corrente para segurá-la se ela quebrar ou se soltar**. A ferramenta também possui um **sistema de lubrificação automática** da corrente e um **botão de travamento do gatilho para evitar partidas acidentais**. A ferramenta consiste numa **barra guia, uma corrente e uma cobertura para proteger a barra e a corrente durante o transporte e armazenamento**.



**BRUSHLESS MOTOR**  
**20V**  
**720W**

93 dB(A) 7.8m/s 22cm

130ml 9.5mm (3/8")

254mm (10")  
350x225x245mm  
600x225x245mm

INTERRUPTOR DE SINAL  
**15098** 11,50€

BOMBA DE ÓLEO  
**15101** 11,00€

CORRENTE DE SERRA  
**15104** 31,50€

GATILHO  
**15099** 5,50€

ROTOR  
**15102** 40,00€

BARRA DE GUIA  
**15105** 30,00€

PLACA DE CIRCUITO IMPRESSO  
**15100** 70,00€

ESTATOR  
**15103** 20,50€

ALÇA EM D ADICIONAL  
**15106** 15,00€



JARDINAGEM

## TESOURAS ELÉTRICAS

**60031**  
161,50€

2,2

1



Bateria não incluída.

Esta ferramenta foi projetada para **tarefas de jardinagem** rápidas e fáceis, como corte de cercas vivas ou arbustos. Leveza de construção e alimentação por bateria **facilitam o transporte** da ferramenta de um local para outro.

O kit inclui uma **tampa protetora de lâmina** para manter o corta-sebes em boas condições, **uma cobertura** para ajudar a manter aparas ou outros detritos longe **das mãos e olhos do operador** e uma **alça extra** para maior controle e um ambiente de trabalho confortável. Além disso, o design oferece dois interruptores e um **botão de bloqueio**, que evita o acionamento acidental da ferramenta.

**20V**  
**230W**

65Mn steel <93dB(A) 1490RPM 475mm <2.5m/s2

18mm 45° 920x215x192mm

20-25min

INTERRUPTOR DE GATILHO TRASEIRO  
**15114** 6,00€

MICRO INTERRUPTOR #8  
**15115** 8,50€

PLACA DE CIRCUITO  
**15116** 29,50€

MOTOR  
**15117** 29,50€

CON JUNTO DE DISCO DE CORTE  
**15118** 52,00€

MICRO INTERRUPTOR #31  
**15119** 10,00€

INTERRUPTOR DE GATILHO DIANTEIRO  
**15120** 6,50€

ALÇA AUXILIAR D  
**15121** 12,00€

Use-os com baterias JBM: uma única bateria adequada para todas as ferramentas

BATERIA DE LÍTIO

2.0Ah



**60012**

4.0Ah



**60013**

6.0Ah



**60015**

CARREGADOR

4A



**60016**

6A



CARREGADOR RÁPIDO

**60017**

# MÁQUINA DE JARDIM MULTIFUNÇÃO ELÉTRICA (4 EM 1)

**60040**  
439,50€

8,3  
Bateria não incluída.

Bateria não incluída.

A ferramenta elétrica multifunção 4 em 1 para jardim foi projetada para uma ampla variedade de tarefas ao ar livre, como limpar espaços verdes, aparar sebes, cortar galhos e muito mais. A ferramenta é ideal para a manutenção completa do jardim.

- O conjunto completo inclui serra, tesoura de treliça e roçadeira com cabeça rosca e lâmina tripla.

- Ele inclui:

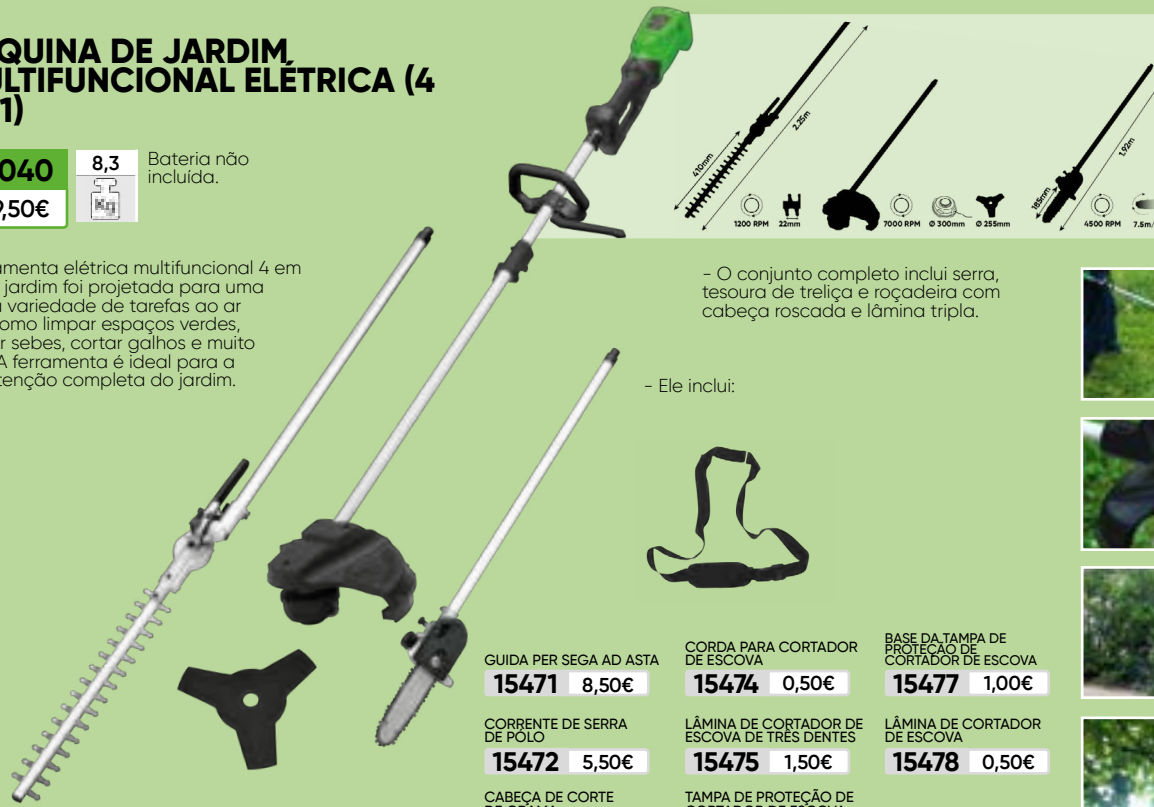

BRUSHLESS MOTOR  
20V  
4 IN 1

GUIA PER SEGA AD ASTA  
**15471** 8,50€

CORDE PARA CORTADOR DE ESCOVA  
**15474** 0,50€

BASE DA TAMPA DE PROTEÇÃO DE CORTADOR DE ESCOVA  
**15477** 1,00€

CORRENTE DE SERRA DE POLO  
**15472** 5,50€

LÂMINA DE CORTADOR DE ESCOVA DE TRÊS DENTES  
**15475** 1,50€

LÂMINA DE CORTADOR DE ESCOVA  
**15478** 0,50€

CABEÇA DE CORTE DE GRAMA  
**15473** 3,00€

TAMPA DE PROTEÇÃO DE CORTADOR DE ESCOVA  
**15476** 1,50€



## VENTILADOR ELÉTRICO

**60030**  
118,00€

1,75 1  
Bateria não incluída.

Esta ferramenta foi projetada para **recolher folhas, grama, papel e materiais semelhantes**. Leveza de construção e alimentação por bateria facilitam o transporte da ferramenta de um local para outro.

O design apresenta um interruptor de **fluxo de ar alto/ baixo** e interruptor de volume e uma **alça macia para fácil operação**.



20V 280W  
MOTOR POWER

10-35min  
15000 RPM  
90 dB(A)  
2.5(m/s²)  
Ø 70.5mm  
ADJUSTABLE SPEED

MICRO INTERRUPTOR  
**15107** 7,50€

PLACA DE CIRCUITO IMPRESSO  
**15109** 28,00€

MOTOR  
**15111** 32,50€

TUBULAÇÃO DE SANGRIA  
**15113** 15,00€

INTERRUPTOR DE GATILHO  
**15108** 5,50€

CHAVE  
**15110** 10,00€

CONE DE DIVERSÃO DE ENTRADA  
**15112** 7,00€

ALTO LOW  
22m/s (49MPH)  
312m³/h (186CFM)

BAIXO HIGH  
38m/s (85MPH)  
520m³/h (310CFM)

Use-os com baterias JBM: uma única bateria adequada para todas as ferramentas

BATERIA DE LÍTIO

2.0Ah



**60012**

4.0Ah



**60013**

6.0Ah



**60015**

CARREGADOR



4A  
**60016**



CARREGADOR RÁPIDO  
6A  
**60017**



## FAROL DE TRABALHO LED

**60004**  
79,00€

1,45 4 96

Bateria não incluída.

Esta lâmpada LED de operação foi projetada para **criar a iluminação necessária** na área de trabalho e em outros locais. É alimentada por uma bateria de íon de lítio portátil, que torna o dispositivo portátil e **ideal para qualquer local de trabalho e situações em que o acesso à rede elétrica seja limitado**. Quando a bateria está descarregada, a lâmpada pode ser conectada a uma rede com uma tensão de 230 V usando um **cabo de rede** localizado na parte traseira do dispositivo.

- Ele inclui:  
Cabo.



1,5m



**20V 2400 LED LM**

INTERRUPTOR  
**14636 30,00€**

TRIPODE PARA FAROL DE TRABALHO LED (REF. 60004)

**15049**  
44,50€

↑1200mm  
↓595mm

1,84

280mm

325mm

275mm

1200mm



ILUMINAÇÃO

## LÂMPADA DE TRABALHO PORTÁTIL LED

**60035**  
30,00€

0,25 5

Bateria não incluída.

Esta lâmpada de trabalho LED é projetada para **fornecer a iluminação necessária na área de trabalho e em outros locais**. É alimentada por uma bateria portátil de íon de lítio, tornando-a portátil e ideal para todos os locais de trabalho e situações onde a energia elétrica é limitada.

O difusor da lâmpada LED fornece um fluxo luminoso de **500 e 1000 lumens**, e o **mecanismo giratório da lâmpada (90°)** permite ajustar o ângulo desejado. Também está incluída uma alça macia para um manuseio mais confortável e um gancho de suspensão para prender a outro objeto.

**20V 10W**

500 Lm

1000 Lm

90°

220-240V 50Hz

Parpadeante Flashing



PLACA DE CIRCUITO IMPRESSO **15124 9,50€** PLACA DE CIRCUITO IMPRESSO **15125 23,00€**

Use-os com baterias JBM: uma única bateria adequada para todas as ferramentas

BATERIA DE LÍTIO

2.0Ah



**60012**

4.0Ah



**60013**

6.0Ah



**60015**

CARREGADOR



4A  
**60016**  
48,50€



CARREGADOR RÁPIDO  
6A  
**60017**  
63,50€

## SCOOTER ELÉTRICO 36V 350W MOTOR SEM ESCOVA

53920

537,00€

13

1

Bateria incluída e embutida.

- Dimensões desdobradas: 109x42x109 cm
- Dimensões da plataforma: 67x14 cm
- Altura do volante: 109 cm
- Máx. alcance: 26 km
- Capacidade de escalada: 15°
- Carga útil máxima: 107 kg



**350W**

107kg

36V  
7500MAH

100-240V  
3-4H



26km

LCD  
Pantalla Screen

Disco trasero  
Rear disc

22cm

S  
Acero Steel

15+



Gerencie todas as **características técnicas** do seu **celular**:

- Indicador de nível de bateria.
- Alterar o modo de limite de velocidade.
- Altere o modo de inicialização.
- Controle a velocidade com que você dirige.
- Liga / desliga a luz LED.
- Trava a scooter para que não possa ser usada ou roubada (bloqueio do motor).

DISCO TRASEIRO



DISPLAY LCD



DIMENSÕES DOBRADAS  
109X42X46CM



## CORTADOR DE GRAMA ROBÔ

52598

1.080,00€

7,5

1

- Robô cortador de grama autônomo.
- Sem fio e fácil de guardar.

5200 mAh  
Capacidade de la batería  
Battery capacity

1400m<sup>2</sup>  
Superficie de corte  
Mowing area

2,5H

2H

22m/min

115,44W  
Consumo de energía  
Power consumption

AC 100-240V  
50/60Hz  
Tensión de entrada  
Input Voltag

DC 15-25,5V  
Tensión de salida  
Output Voltag

IP X4

70 dB



Altura de corte:  
2,5 - 5,5cm

Largura de corte: 18cm

estação para carregar

Velocidade de rotação da lâmina: 3500rpm



FIO DE CONEXÃO  
150 M

15424 105,00€

PREGOS DA ESTAÇÃO  
DE INSTALAÇÃO

15427 9,00€

ADAPTADOR

15430 83,00€

GARAGEM PARA  
CORTADOR DE  
GRAMA

15433 169,00€

MOTOR DE CORTE

15436 97,00€

SUPORTES PARA FIO  
DE CONEXÃO

15425 50,00€

BATERIA 22,2 V,  
2 600 mAh

15428 238,00€

ESTACION BASE

15431 241,00€

RODA TRASEIRA E  
MOTOR

15434 147,00€

MÃE PLACA

15437 305,50€

LÂMINA DE CORTE E  
PARAFUSOS

15426 10,00€

FIO DE EXTENSÃO 5 M

15429 23,50€

TOMADA DO FIO DE  
CONEXÃO

15432 18,50€

PLACA DE CORTE E  
PLACA DE PROTEÇÃO

15435 24,50€

SENSOR DO FIO DE  
CONEXÃO

15438 31,00€

RODAS DIANTEIRAS

15439 52,00€

CONEXÃO  
DE APP





# Use-os com baterias JBM: uma única bateria adequada para todas as ferramentas

Três tipos de bateria e dois tipos de carregador.  
Escolha o que você preferir!

\*Pilhas e carregadores  
NÃO INCLUIDOS  
nas ferramentas.



## BATERIA DE LITIO



INDICADOR DE  
ENERGIA



PROTEÇÃO CONTRA  
CURTO-CIRCUITO



PROTEÇÃO CONTRA  
SUPERAQUECIMENTO



PROTEÇÃO CONTRA  
SOBRECARGA

### 20V

### 12V

2.0Ah



4.0Ah



6.0Ah



2.0Ah



PARA REF. 60024

**60012**

0,45 5 1.080

41,50€



**60013**

0,75 5 840

79,50€



**60015**

1 5 550

122,00€



**60026**

0,20 8 5

33,00€



## CARREGADOR

50-60Hz

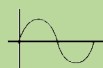

100V  
240V



INDICADOR DE  
ENERGIA



PROTEÇÃO CONTRA  
SUPERAQUECIMENTO



PROTEÇÃO CONTRA  
SOBRECARGA

### 20V



PROTEÇÃO CONTRA  
CURTO-CIRCUITO

### 12V



4A

**60016**

0,70 5 240

48,50€



6A  
RÁPIDO



**60017**

0,80 5 240

63,50€



CARREGADOR DE 12 V  
PARA REF. 60026

**60025**

0,30 5 4

28,50€



2.0AH 30min +/-10min 4.0AH 60min +/-15min

6.0AH 90min +/-15min

2.0AH 30min +/-10min 4.0AH 45min +/-10min

6.0AH 60min +/-15min

2.0AH 60min +/-10min



BATERIAS/  
CARREGADORES



## FORMÃO SDS-PLUS

- Material: aço 40Cr, jato de areia.



60023

PARA ALVENARIA

DE FINO AFIADO - 14x250mm

**14837**  
3,00€



DE FINO PLANO - 20x250mm

**14838**  
3,00€



DE SULCO - 250mm

**14840**  
4,00€



DE FINO PLANO - 40x250mm

**14839**  
4,00€



14837



14839

14838

14840

## ADAPTADOR SDS-PLUS DE 1/2" PARA CARTUCHO DE PERFURAÇÃO

**14841**  
1,50€



- Material: aço 40Cr, jato de areia  
- Comprimento: 7,5 cm  
- Diâmetro: 1 cm  
- Peso: 45 g



60023

PARA ALVENARIA



## KIT DE BROCAS DO PERFURADOR COM A HASTE SDS-PLUS

**53850**  
13,50€



**7**  
PCS

60023

5x110, 6x110, 6x160, 8x110, 8x160, 10x160, 12x160mm

- Ranhura simples, ponta plana, uso do jato de areia.  
- Material: pontas de aço de liga YG8, base de aço carbono.



PARA ALVENARIA



### DESMANCHA DISPONÍVEL

REF.	mm	kg	pcs	€
14826	Ø 5x110mm	0,05	125 500	1,50€
14828	Ø 6x110mm	0,05	25 500	1,50€
14830	Ø 8x110mm	0,04	25 500	1,50€
14829	Ø 6x160mm	0,04	25 500	1,50€
14831	Ø 8x160mm	0,05	25 500	1,50€
14832	Ø 10x160mm	0,05	25 200	2,00€
14920	Ø 12x160mm	0,10	100 200	2,50€

### VOCÊ PODE GOSTAR...

REF.	mm	kg	pcs	€
14825	Ø 4x110mm	0,05	100 200	1,50€
14827	Ø 5x160mm	0,04	25 500	2,00€
14833	Ø 10x210mm	0,10	20 200	2,05€
14834	Ø 12x210mm	0,10	100 200	2,50€
14835	Ø 14x210mm	0,10	20 125	3,00€
14836	Ø 16x210mm	0,14	20 120	3,50€

## CARTUCHO DE PERFURAÇÃO DE MUDANÇA RÁPIDA 2-13 MM 1/2" - 20 UNF

**14842**  
7,50€



- Tipo: sem chave  
- Faixa de fixação: 2-13 mm  
- Rosca: 1/2" - 20UNF

- Material: aço  
- Comprimento: 6 cm  
- Diâmetro: 4 cm



60023

## KIT DE BROCAS PARA CONCRETO

- Material: pontas de aço de liga YG8, base de aço carbono.

3-10MM

**53861**  
5,00€

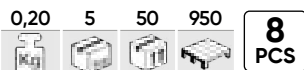

3x60, 4x75, 5x80, 6x100, 7x100, 8x120, 9x120, 10x120mm

4-10MM

**53860**  
3,50€



4x75, 5x80, 6x100, 8x120, 10x120mm



PARA ALVENARIA

60006

### DESMANCHA DISPONÍVEL

REF.	mm	kg	pcs	€
14907	Ø 3x60mm	0,01	50 100	0,50€
14908	Ø 4x75mm	0,01	50 100	0,60€
14909	Ø 5x80mm	0,01	50 100	0,80€
14910	Ø 6x100mm	0,01	50 100	1,00€
14911	Ø 7x100mm	0,01	50 100	1,30€
14912	Ø 8x120mm	0,05	50 100	1,55€
14913	Ø 9x120mm	0,05	50 100	1,90€
14914	Ø 10x120mm	0,04	20 100	2,10€



### VOCÊ PODE GOSTAR...

REF.	mm	kg	pcs	€
14915	Ø 11x150mm	0,05	20 100	2,65€
14916	Ø 12x150mm	0,06	20 100	2,95€
14917	Ø 13x150mm	0,10	20 100	3,45€



53861



DESMANCHA DISPONÍVEL



53860



DESMANCHA DISPONÍVEL



## KIT DE BROCAS ESPIRAIS HSS 4341

- Material: HSS 4341

1-10MM

**53852**

175,50€

4,20 4 **170**  
PCS

1x34, 1.5x40, 2x49, 2.5x57, 3x61, 3.5x70, 4x75, 4.5x80, 5x86, 5.5x93, 6x93, 6.5x101, 7x109, 7.5x109, 8x117, 8.5x117, 9x125, 9.5x125, 10x133mm

- O conjunto inclui 170 brocas:  
1,0 - 8,0 mm x 10 peças (a cada 0,5 mm).  
8,5 - 10 mm x 5 peças (a cada 0,5 mm).



DESMANCHA DISPONÍVEL

1-13MM

**53856**

53,00€

1,32 5 10 **25**  
PCS

1x34, 1.5x40, 2x49, 2.5x57, 3x61, 3.5x70, 4x75, 4.5x80, 5x86, 5.5x93, 6x93, 6.5x101, 7x109, 7.5x109, 8x117, 8.5x117, 9x125, 9.5x125, 10x133, 10.5x133, 11x142, 11.5x142, 12x151, 12.5x151, 13x151mm



DESMANCHA DISPONÍVEL

1-10MM

**53854**

23,50€

0,63 5 20 **19**  
PCS

1x34, 1.5x40, 2x49, 2.5x57, 3x61, 3.5x70, 4x75, 4.5x80, 5x86, 5.5x93, 6x93, 6.5x101, 7x109, 7.5x109, 8x117, 8.5x117, 9x125, 9.5x125, 10x133mm



DESMANCHA DISPONÍVEL



60006

HSS-G  
4341



PARA METAIS



DESMANCHA DISPONÍVEL

REF.	mm			€
14868	Ø 1x34mm	0,01	50 400	0,55€
14869	Ø 1.5x40mm	0,01	50 400	0,60€
14870	Ø 2x49mm	0,01	50 400	1,00€
14871	Ø 2.5x57mm	0,01	50 400	1,00€
14872	Ø 3x61mm	0,01	50 400	1,00€
14873	Ø 3.5x70mm	0,01	50 400	1,00€
14874	Ø 4x75mm	0,01	50 400	1,00€
14875	Ø 4.5x80mm	0,01	50 400	1,50€
14876	Ø 5x86mm	0,01	50 300	1,50€
14877	Ø 5.5x93mm	0,02	50 300	1,50€
14878	Ø 6x93mm	0,02	25 400	2,00€
14879	Ø 6.5x101mm	0,02	25 400	2,00€
14880	Ø 7x109mm	0,03	25 400	2,50€
14881	Ø 7.5x109mm	0,03	25 400	2,50€
14882	Ø 8x117mm	0,04	25 400	3,00€
14883	Ø 8.5x117mm	0,04	25 400	3,50€
14884	Ø 9x125mm	0,05	25 400	3,65€
14885	Ø 9.5x125mm	0,05	25 400	4,00€
14886	Ø 10x133mm	0,06	25 400	4,60€
14887	Ø 10.5x133mm	0,07	25 400	5,00€
14888	Ø 11x142mm	0,08	25 400	6,00€
14889	Ø 11.5x142mm	0,09	25 400	6,50€
14890	Ø 12x151mm	0,10	25 300	7,00€
14891	Ø 12.5x151mm	0,09	25 200	7,50€
14892	Ø 13x151mm	0,09	25 200	8,00€

## KIT DE BROCAS ESPIRAIS HSS 4241 PRETO

- Material: HSS 4241 PRETO.

1-10MM

**53851**

74,50€

3,80 4 **170**  
PCS

1x34, 1.5x40, 2x49, 2.5x57, 3x61, 3.5x70, 4x75, 4.5x80, 5x86, 5.5x93, 6x93, 6.5x101, 7x109, 7.5x109, 8x117, 8.5x117, 9x125, 9.5x125, 10x133mm

- O conjunto inclui 170 brocas:  
1,0 - 8,0 mm x 10 peças (a cada 0,5 mm).  
8,5 - 10 mm x 5 peças (a cada 0,5 mm).



DESMANCHA DISPONÍVEL

1-13MM

**53855**

21,50€

1,19 5 10 **25**  
PCS

1x34, 1.5x40, 2x49, 2.5x57, 3x61, 3.5x70, 4x75, 4.5x80, 5x86, 5.5x93, 6x93, 6.5x101, 7x109, 7.5x109, 8x117, 8.5x117, 9x125, 9.5x125, 10x133, 10.5x133, 11x142, 11.5x142, 12x151, 12.5x151, 13x151mm



DESMANCHA DISPONÍVEL

1-10MM

**53853**

11,50€

0,58 5 20 **19**  
PCS

1x34, 1.5x40, 2x49, 2.5x57, 3x61, 3.5x70, 4x75, 4.5x80, 5x86, 5.5x93, 6x93, 6.5x101, 7x109, 7.5x109, 8x117, 8.5x117, 9x125, 9.5x125, 10x133mm



DESMANCHA DISPONÍVEL



60006

HSS-R  
4241



PARA METAIS



DESMANCHA DISPONÍVEL

REF.	mm			€
14843	Ø 1x34mm	0,01	50 400	0,50€
14844	Ø 1.5x40mm	0,01	50 400	0,50€
14845	Ø 2x49mm	0,01	50 400	0,50€
14846	Ø 2.5x57mm	0,01	50 400	0,50€
14847	Ø 3x61mm	0,01	50 400	0,50€
14848	Ø 3.5x70mm	0,01	50 400	0,50€
14849	Ø 4x75mm	0,01	50 400	1,00€
14850	Ø 4.5x80mm	0,01	50 400	1,00€
14851	Ø 5x86mm	0,01	50 300	1,00€
14852	Ø 5.5x93mm	0,02	50 300	1,00€
14853	Ø 6x93mm	0,02	25 400	1,00€
14854	Ø 6.5x101mm	0,02	25 400	1,00€
14855	Ø 7x109mm	0,03	25 400	1,00€
14856	Ø 7.5x109mm	0,03	25 400	1,00€
14857	Ø 8x117mm	0,03	25 400	1,50€
14858	Ø 8.5x117mm	0,04	25 400	1,50€
14859	Ø 9x125mm	0,04	25 400	1,50€
14860	Ø 9.5x125mm	0,05	25 400	2,00€
14861	Ø 10x133mm	0,06	25 400	2,00€
14862	Ø 10.5x133mm	0,07	25 400	2,00€
14863	Ø 11x142mm	0,07	25 400	2,50€
14864	Ø 11.5x142mm	0,07	25 400	2,50€
14865	Ø 12x151mm	0,08	25 300	2,50€
14866	Ø 12.5x151mm	0,09	25 200	3,00€
14867	Ø 13x151mm	0,09	25 200	3,00€

## FORMÃO SDS-PLUS

- Material: aço 40Cr, jato de areia.



60023

DE FINO AFIADO - 14x250mm

**14837**

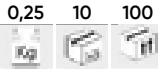

3,00€

DE FINO PLANO - 20x250mm

**14838**



3,00€

DE SULCO - 250mm

**14840**



4,00€

DE FINO PLANO - 40x250mm

**14839**



4,00€



## KIT DE BROCAS DO PERFURADOR COM A HASTE SDS-PLUS

**53850**

13,50€



60023

5x110, 6x110, 6x160, 8x110, 8x160, 10x160, 12x160mm

- Ranhura simples, ponta plana, uso do jato de areia.  
- Material: pontas de aço de liga YG8, base de aço carbono.



### DESMANCHA DISPONÍVEL

REF.	mm	kg	Ca	Pa	€
14826	Ø 5x110mm	0,05	125	500	1,50€
14828	Ø 6x110mm	0,05	25	500	1,50€
14830	Ø 8x110mm	0,04	25	500	1,50€
14829	Ø 6x160mm	0,04	25	500	1,50€
14831	Ø 8x160mm	0,05	25	500	1,50€
14832	Ø 10x160mm	0,05	25	200	2,00€
14920	Ø 12x160mm	0,10	100	200	2,50€

### ▶ VOCÊ PODE GOSTAR...

REF.	mm	kg	Ca	Pa	€
14825	Ø 4x110mm	0,05	100	200	1,50€
14827	Ø 5x160mm	0,04	25	500	2,00€
14833	Ø 10x210mm	0,10	20	200	2,05€
14834	Ø 12x210mm	0,10	100	200	2,50€
14835	Ø 14x210mm	0,10	20	125	3,00€
14836	Ø 16x210mm	0,14	20	120	3,50€

## ADAPTADOR SDS-PLUS DE 1/2" PARA CARTUCHO DE PERFURAÇÃO

**14841**

1,50€

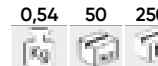

- Material: aço 40Cr, jato de areia  
- Comprimento: 7,5 cm  
- Diâmetro: 1 cm  
- Peso: 45 g



60023

PARA ALVENARIA

ACO 40CR



## CARTUCHO DE PERFURAÇÃO DE MUDANÇA RÁPIDA 2-13 MM 1/2" - 20 UNF

**14842**

7,50€



- Tipo: sem chave  
- Faixa de fixação: 2-13 mm  
- Rosca: 1/2" - 20UNF  
- Material: aço  
- Comprimento: 6 cm  
- Diâmetro: 4 cm



60023

## KIT DE BROCAS PARA CONCRETO

- Material: pontas de aço de liga YG8, base de aço carbono.



60006

3-10MM

**53861**

5,00€



8 PCS

3x60, 4x75, 5x80, 6x100, 7x100, 8x120, 9x120, 10x120mm

4-10MM

**53860**

3,50€



5 PCS

4x75, 5x80, 6x100, 8x120, 10x120mm

### DESMANCHA DISPONÍVEL

REF.	mm	kg	Ca	Pa	€
14907	Ø 3x60mm	0,01	50	100	0,50€
14908	Ø 4x75mm	0,01	50	100	0,60€
14909	Ø 5x80mm	0,01	50	100	0,80€
14910	Ø 6x100mm	0,01	50	100	1,00€
14911	Ø 7x100mm	0,01	50	100	1,30€
14912	Ø 8x120mm	0,05	50	100	1,55€
14913	Ø 9x120mm	0,05	50	100	1,90€
14914	Ø 10x120mm	0,04	20	100	2,10€

### ▶ VOCÊ PODE GOSTAR...

REF.	mm	kg	Ca	Pa	€
14915	Ø 11x150mm	0,05	20	100	2,65€
14916	Ø 12x150mm	0,06	20	100	2,95€
14917	Ø 13x150mm	0,10	20	100	3,45€



DESMANCHA DISPONÍVEL



DESMANCHA DISPONÍVEL





# SERRAS

## PARA METAL (AÇO INOXIDÁVEL, ALUMÍNIO, COBRE)

PARA	REF.	DESCRIÇÃO	0,08	0,19	0,26	0,01	€
60011	14989	Serra circular 24 dentes 115mm	-	20	100	6,00€	
60007	14988	Serra circular 24 dentes 165mm	-	20	40	8,00€	
60022	14990	Serra circular 40 dentes 185mm	-	20	40	10,50€	
60019	14995	Lâminas de serra reciprocadora 150mm 24tpi	2	20	200	8,00€	
60010	14993	Lâminas da serra de rodear t118a	5	20	200	5,00€	

## PARA MADEIRA

PARA	REF.	DESCRIÇÃO	0,07 <th>0,18 <th>0,24 <th>0,01 <th>€</th> </th></th></th>	0,18 <th>0,24 <th>0,01 <th>€</th> </th></th>	0,24 <th>0,01 <th>€</th> </th>	0,01 <th>€</th>	€
60011	14986	Serra circular 24 dentes 115mm	-	20	100	4,00€	
60007	14985	Serra circular 24 dentes 165mm	-	20	40	6,00€	
60022	14987	Serra circular 40 dentes 185mm	-	20	40	8,50€	
60019	14994	Lâminas de serra reciprocadora 150mm 6tpi	2	20	200	3,50€	
60010	14991	Lâminas da serra de rodear t244d	5	20	200	2,00€	

**14989** **14986**

METAL MADEIRA

Ø 115mm 10mm x24 1000 RPM



- Material: lâminas YG8, base de carboneto de tungstênio.

**14988** **14985**

METAL MADEIRA

Ø 165mm 20mm x24 1000 RPM



- Material: lâminas YG8, base de carboneto de tungstênio.

**14990** **14987**

METAL MADEIRA

Ø 185mm 25.4mm 1.3mm x40 1000 RPM



- Material: lâminas YG8, base de carboneto de tungstênio.

**14995**

METAL 150mm 24 TPI 10mm CORTA MÁX. MAX. CUT



- Material: aço rápido.

**14993**

METAL 75mm 8mm CORTA MÁX. MAX. CUT T118A

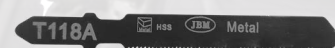

- Material: aço rápido.

**14994**

MADEIRA 150mm 6 TPI 150mm CORTA MÁX. MAX. CUT



- Material: aço de alto carbono.

**14991**

MADEIRA 100mm 100mm CORTA MÁX. MAX. CUT T244D



- Material: aço de alto carbono.

## CÍRCULO DE CORTE

- Material: Óxido de alumínio fundido monocristalino SA 50% / Óxido de alumínio fundido branco 50%

PARA METAIS E AÇO INOXIDÁVEL

**60008/60028**

### PARA METAL

REF.	DESCRIÇÃO	0,05	0,70	0,15	0,78	€
14893	T42 - 115x2.5mm	50	100	2,00€		
14894	T42 - 125x2.5mm	50	100	2,60€		
14895	T27 - 115x6mm	25	100	2,90€		
14896	T27 - 125x6mm	25	100	3,60€		



### PARA AÇO INOXIDÁVEL

REF.	DESCRIÇÃO	0,01	0,03	0,04	€
14897	T41 - 115x1mm	50	400	1,00€	
14898	T41 - 125x1mm	50	400	1,00€	
14899	T41 - 115x1.6mm	50	400	2,60€	
14900	T41 - 125x1.6mm	50	400	2,85€	



**14893** **T42**

Ø 115mm 22.23mm 2.5mm 11.300 RPM 80 m/s

**14895** **T27**

Ø 115mm 22.23mm 6mm 11.300 RPM 80 m/s

**14897** **T41**

Ø 115mm 22.23mm 1mm 11.300 RPM 80 m/s

**14898** **T41**

Ø 125mm 22.23mm 1mm 11.300 RPM 80 m/s

**14894** **T42**

Ø 125mm 22.23mm 2.5mm 11.300 RPM 80 m/s

**14896** **T27**

Ø 125mm 22.23mm 6mm 11.300 RPM 80 m/s

**14899** **T421**

Ø 115mm 22.23mm 1.6mm 11.300 RPM 80 m/s

**14900** **T41**

Ø 125mm 22.23mm 1.6mm 11.300 RPM 80 m/s

## PORCA DE REMOÇÃO RÁPIDA M14 PARA REBARBADORA

**15014**

20,00€

0,10 50 100



**60008/60028**



## BANDEJA

**14622**  
17,00€



PARA REF. 60001, 60003,  
60004, 60020

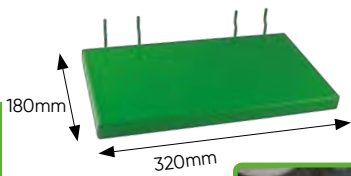

**14624**  
17,00€



PARA REF. 60007,  
60010, 60011

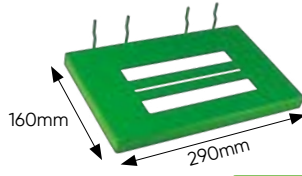

## GANCHO

**14625**  
14,00€



PARA REF. 60008,  
60009

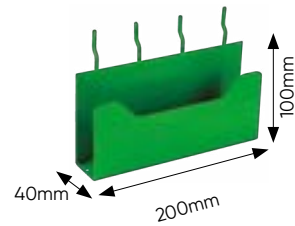

## GANCHO

**14623**  
8,00€

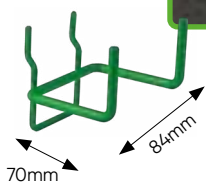
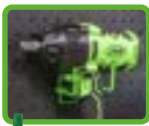

**14626**  
7,00€

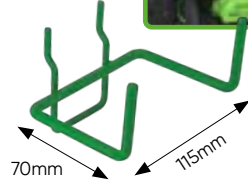

PARA REF. 60005, 60006, 60018

PARA REF. 60023

## MOCHILA PARA FERRAMENTAS ELÉTRICAS - GRANDE

**53782**  
14,00€

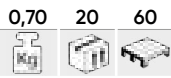

**25Kg/13L**



## MOCHILA PARA FERRAMENTAS ELÉTRICAS

**53702**  
24,50€



PEQUENA



**53703**  
32,00€



MÉDIA



**53704**  
36,00€



GRANDE



ALÇA DE OMBRO



DIVISÓRIA INTERNA



BOLSOS TRASEIROS E LATERAIS

## MOCHILA PARA FERRAMENTAS

**53258**  
75,40€



**15Kg**

- Não inclui ferramentas.



## MALA DE FERRAMENTAS

**53253**  
98,00€



**20Kg/18L**

- 600D Polyester.  
- Não inclui ferramentas.





GAMBIARRA



112

GAMBIARRA DE LUZ FRONTAL DE CABEÇA /  
CARREGADOR ISQUEIRO E TOMA CORRENTE



116

LUPA LED / LANTERNA DE BOLSO

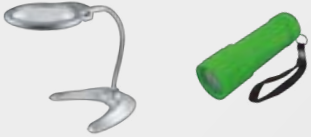

117

LÂMPADA LED



118

REFLETOR / ALINHADOR DE FARÓIS



119

BALIZA DE EMERGÊNCIA LED / BALIZA DE  
EMERGÊNCIA LED

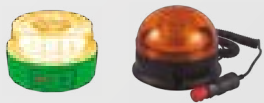

120

AVISADORES ACÚSTICOS



123

FAROS DE TRABAJO



123

PARA REBOQUE



126

LÂMPADAS PARA TURISMOS



127



# ILUMINAÇÃO



**SERIE362**

## LUZ DE TRABALHO 400LM

53734

18,00€

0,25 20 60 1.080



BASE ROTATIVA  
MAGNETIZADA  
360°

380mm

32mm

poderosa luz LED:  
de 30Lm a  
400Lm

SELETOR DE  
INTENSIDA-  
DE DE LUZ

COM CABIDE

CARREGADOR USB

EM EXPOSITOR  
DE 20 UDS

## GAMBIARRA COM BASE MAGNÉTICA ARTICULADA

53465

38,00€

0,4 12 24 384



53466

39,90€

0,4 12 24 384



53467

47,00€

0,4 12 24 336

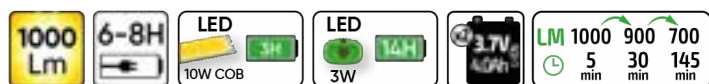

100V 240V 5V 1A

IP 44

6500±400 KELVIN

257mm 50mm 26mm

EM EXPOSITOR  
DE 12 UDS

## LÂMPADA PORTÁTIL COB COM BASE FLEXÍVEL

53216

49,00€

0,6 10 120

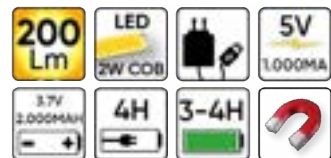

390mm

100mm

180mm

## LÂMPADA PORTÁTIL COB

53217

29,00€

0,3 20 620

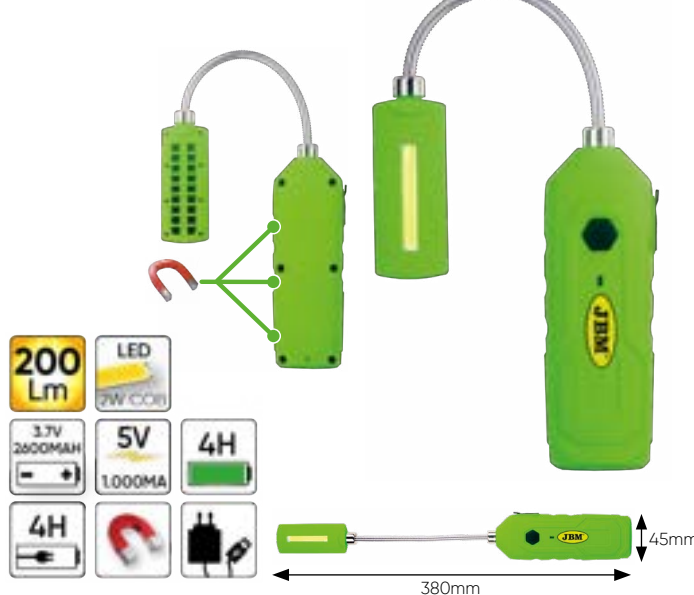



## GAMBIARRA COB EXTRAFINO

53519

29,00€

0,2 12 72 576



EXTRAFINO

12mm

300mm

38mm

EM EXPOSITOR DE 12 UDS



## GAMBIARRA EXTRAPLANA COM LED COB COM BATERIA RECARREGÁVEL

52536

57,00€

0,4 10 330



360mm

50mm



## GAMBIARRA 24+6 LEDS COM IMAN DUPLO TRASEIRO

51889

45,00€

0,43 10 360



255mm 56mm

DUPLO GANCHO E DUPLO MAGNET



## GAMBIARRA EXTRAPLANA COM LED COB

52384

19,00€

0,33 20 600



- Comp. cabo: 5m  
- DC Comp. cabo: 0,1m  
- DC Comp. do cabo até às pinças: 0,3m

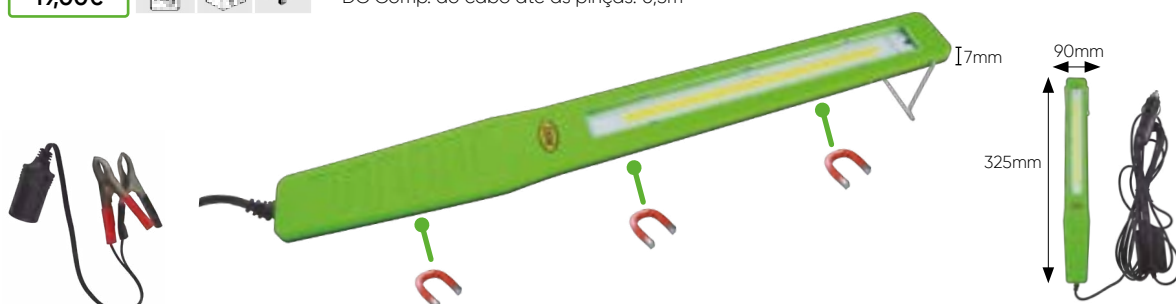

## LANTERNA DE BOLSO COM BATERIA

53776

0,15 12 48 1.728

16,50€

### 3 MODOS DE LUZ



EM EXPOSITOR DE 12 UDS



## LANTERNA DE BOLSO COM BATERIA

52987

0,17 10 40 640

19,00€

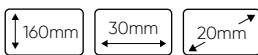

EM EXPOSITOR DE 10 UDS



## LÂMPADA PORTÁTIL COB COM BATERIA

52883

0,31 20 640

38,00€



## LÂMPADA PORTÁTIL COB ULTRAVIOLETA FLEXÍVEL COM BASE MAGNÉTICA

53530

0,3 5 20 620

43,50€



LUZ ULTRAVIOLETA

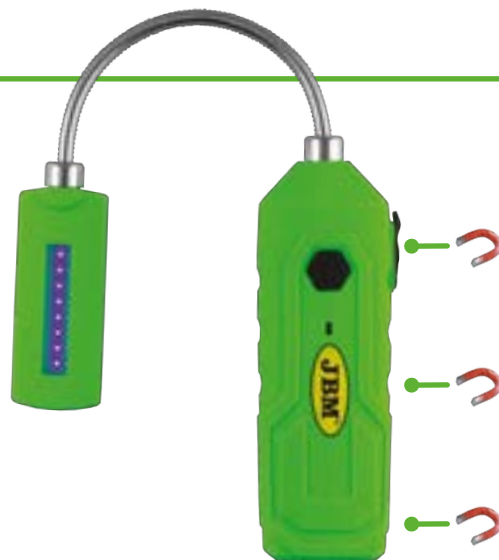

GAMBIARRAS



## LUZ DE TRABALHO LED 400LM

53780

14,50€

0,45 5 20 320



CABO DE ALIMENTAÇÃO DE 2,5M



INCLUI GANCHO SUPERIOR PARA TRABALHAR CONFORTAVELMENTE

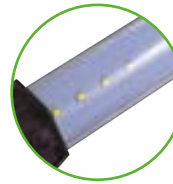

LUZ PODEROSA PERFEITA PARA ILUMINAR A ÁREA DE TRABALHO

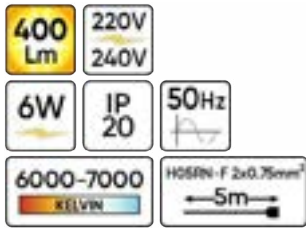

## LÂMPADA DE TRABALHO RECARREGÁVEL

53974

35,50€

0,75 5 20 240



Você quer ver como funciona?



37mm  
240mm  
225mm

GAMBIARRAS

4 MODOS DE ILUMINAÇÃO

100% 50% SOS FLASH



MULTIPOSIÇÃO



## LAMPADA A LED PORTATILE COM LANTERNA / ALTAVOZ / CARREGADOR

53199

24,00€

0,4 18 306



- Gancho de fixação.  
- Altavoz blue-tooth.



# GAMBIARRA DE LUZ FRONTAL DE CABEÇA

COB + LED 350LM

**54004** 0,10 12 96 1.920  
23,00€

**COB**  
350Lm  
3W COB

**LED**  
90Lm  
3W XPE

3.5V  
1200Ah

2.5H

IP  
X4

2m

Gel de sílica  
Silica gel

70g

USB

Hand



350Lm x1  
150Lm x2



150Lm x1  
60Lm x2



ON + **2"**



- Material: sílica gel
- Indicador de energia, indicador de indução
- Modo de ativação do sensor de movimento
- Cabo de carregamento USB incluído

## BOTÃO DO SENSOR DE MOVIMENTO



Pressione para ativar/desativar. Passe a mão na frente do botão para acender e apagar a luz.

GAMBIARRAS

CREE + COB 800LM

**53569** 0,35 10 50 400  
18,00€

**MAX**  
800  
Lm

High/Low  
Flash/COB

x2 18650

LED  
COB + CREE

150M

+2,5H



BATERIAS  
RECARREGÁVEIS



REGULADOR  
DE FOCO

INDICADOR  
LUMINOSO ACESO



**3** MODOS  
DE LUZ



90°



350LM

**53568** 0,2 10 100 400  
12,00€

High/Low  
Flash/SOS

2000  
mAh  
Li-Ion

**MAX**  
350  
Lm

150M

+2,5H



REGULA-  
DOR  
DE FOCO

90°



**3** MODOS  
DE LUZ





## LUPA LED DE MESA

**53227**  
28,00€

0,6 6 24 192

- Até 500 ciclos de carga.  
- LED de luz branca, alta poupança.



## LUPA 8 LED (5x)

**53085**  
29,00€

0,31 10 40 1.500



Inclui:  
- Pano de limpeza  
- Tampa anti-choque

## LANTERNA PLÁSTICA 9 LEDS

**52555**  
1,80€

**52558**  
1,80€

93mm 30mm

0,03 12 48 192 3.456



EM EXPOSITOR DE 12 UDS

27 Lm X9 LED X3 AAA

## LANTERNA DE 8 LEDS IMANTADA

**53427**  
5,00€

0,05 12 96 3.072

45 Lm X6 LED X3 AAA

160mm 32mm



EM EXPOSITOR DE 12 UDS

## LANTERNA DE 21 LEDS

**51326**  
4,40€

0,07 12 144 2.880

63 Lm X21 LED X3 AAA



EM EXPOSITOR DE 12 UDS

- Artigo Auxiliar.  
- 21 Led's de larga duração.

## LANTERNA DE DINAMO DE 2 LEDS

**51573**  
2,50€

0,07 12 96 3.456

6 Lm X2 LED

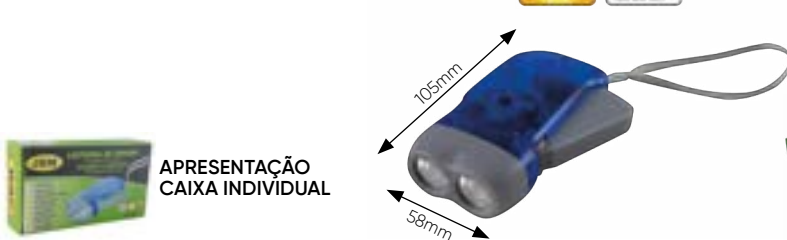

APRESENTAÇÃO CAIXA INDIVIDUAL

## LANTERNA DE DINAMO DE 3 LEDS

**51446**  
2,50€

0,08 12 96 3.456

10 Lm X3 LED



EM EXPOSITOR DE 12 UDS

## PILHAS DE RECAMBIO

"AAA" R03 1,5V

**51258**  
0,15€

0,01 60 2.400

PARA REF. 51325, 51326, 51829, 52233, 51001, 52582, 52555, 52556, 52557, 52558, 52584



x3

PILHA QUADRADA 9V

**10923**  
1,10€

0,05 10 500 1.000

PARA REF. 52162, 52450, 51929, 50942



## LÂMPADA LED COM SUPORTE MAGNÉTICO

53707

2,25 4 80

152,50€



1000 Lm



3 LEDS  
1000LM



7-8H

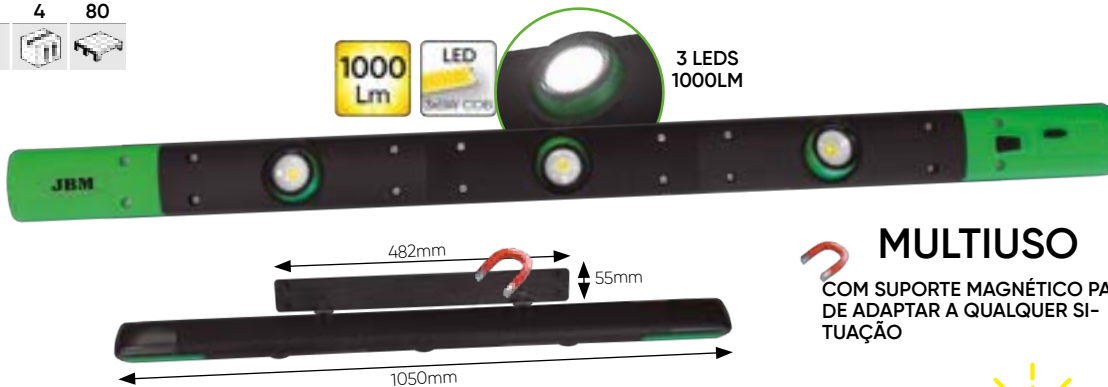

### MULTIUSO

COM SUPORTE MAGNÉTICO PARA DE ADAPTAR A QUALQUER SITUAÇÃO

3 MODOS DE LUZ



PERMITE DIRECIONAR O FOCO DE LUZ INDIVIDUALMENTE DONDE SEJA NECESSÁRIO



360°

LUZES INDICADORAS DO ESTADO DA BATERIA



BATERIA RECARREGÁVEL



AUMENTAR SIGNIFICATIVAMENTE A VISIBILIDADE NA ÁREA DE TRABALHO.

## LÂMPADA DE INSPEÇÃO DA COBERTURA DO MOTOR COM BRAÇOS EXTENSÍVEIS

53570

2,7 4 48

154,00€



1000 Lm



3 LEDS  
1000LM



7-8H

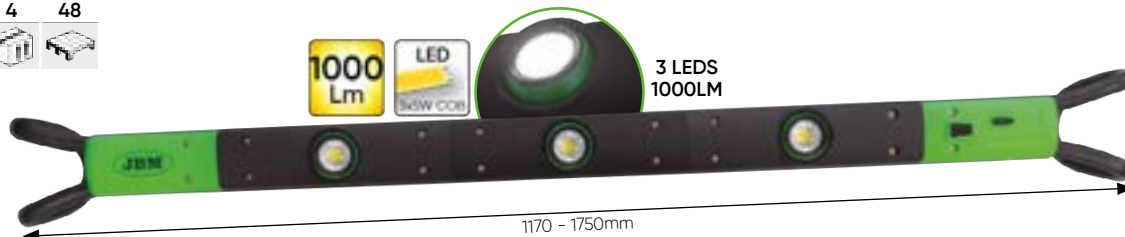

BRAÇOS EXTENSÍVEIS DE 117CM A 175CM

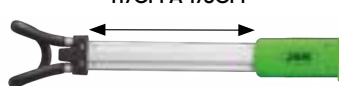

PERMITE DIRECIONAR O FOCO DE LUZ INDIVIDUALMENTE DONDE SEJA NECESSÁRIO



360°

LUZES INDICADORAS DO ESTADO DA BATERIA



BATERIA RECARREGÁVEL



3 MODOS DE LUZ

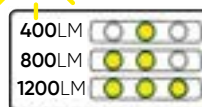

AUMENTAR SIGNIFICATIVAMENTE A VISIBILIDADE NA ÁREA DE TRABALHO



## CARREGADOR ISQUEIRO E TOMA CORRENTE

REF.	DESCRIÇÃO	PARA				
11107	CARREGADOR ISQUEIRO 100-240V OUTPUT: 6V 500MA	53465, 53466, 53467, 53216, 53217, 53519, 52987, 52883, 53530, 53451, 53199, 53570, 53707, 53439, 53568, 53569	0,06	1	250	4,50€
10961	TOMA DE CORRENTE 100-240V OUTPUT: 6V 500MA	53465, 53466, 53467, 53216, 53217, 53519, 52987, 52883, 53530, 53451, 53199, 53570, 53707, 53439, 53568, 53569	0,08	-	150	13,00€
11989	CARREGADOR ISQUEIRO 100-240V OUTPUT: 9V 500MA	52536	0,04	-	200	2,00€
11093	CARREGADOR ISQUEIRO 230V OUTPUT: 6V 500MA	52002	0,06	-	250	4,00€
14031	ADAPTADOR USB PARA TOMADA DE PAREDE ENTRADA: 100-240V SAÍDA: 5V 1000mA	53465, 53466, 53467, 53216, 53217, 53519, 52987, 52883, 53530, 53451, 53199, 53570, 53707, 53439, 53568, 53569	0,1	10	100	10,00€
13839	ADAPTADOR USB PARA TOMADA DE PAREDE 110V/60HZ	53465, 53466, 53467, 53216, 53217, 53519, 52987, 52883, 53530, 53451, 53199, 53570, 53707, 53439, 53568, 53569	0,04	-	200	8,50€
14032	ADAPTADOR USB PARA TOMADA DE ISQUEIRO ENTRADA: 12-24V SAÍDA: 5V, 1A/2.1A	53465, 53466, 53467, 53216, 53217, 53519, 52987, 52883, 53530, 53451, 53199, 53570, 53707, 53439, 53568, 53569	0,1	10	100	12,00€
13815	ADAPTADOR USB PARA TOMADA DE ISQUEIRO ENTRADA: 12-24V SAÍDA: 5V 1000mA	53465, 53466, 53467, 53216, 53217, 53519, 52987, 52883, 53530, 53451, 53199, 53570, 53707, 53439, 53568, 53569	0,1	10	100	8,50€
14033	CABLE USB LONGITUD: 80CM	53216, 53217, 53519, 52987, 53530, 53451, 53199, 53570, 53707, 53439	0,1	10	100	4,50€





# LÂMPADA LED INDUSTRIAL

**54039**

**154,00€**

2,60

1

12

Ø :50cm x 38cm

Projetado especificamente para iluminar instalações industriais, oficinas e edifícios altos.

- Baixo peso
- Potência: 200W
- Fluxo luminoso: 20.000 lm
- Diâmetro: 50 x 38 cm
- Grau de proteção: IP20
- LEDs: MTC
- Driver: Meanwell
- Temperatura de cor: 6.500 K
- Frequência: 50/60 Hz

**20.000Lm**

**200W**

50-60Hz

**220V**

CAPA DE REPOSIÇÃO

**15385**

**18,00€**

50



# REFLETOR LED DE 50W

**53505**

**64,00€**

2,25

8

96

**3.500 Lm**



**x60 LED**

**50W**

**230V**

**50Hz**

**IP 65**

**>25.000h**

**6500 K**

**70M**

**2m**



# TRIPODE PARA REFLETOR LED REF. 53505

**53506**

**36,00€**

↑ 1.830mm  
↓ 840mm

2,3

8

96



**52254**

**64,00€**

↑ 2.770mm  
↓ 1.290mm

3,51

1

4

24

**CE**



- Foco não incluído.

## ALINHADOR DE FARÓIS COM LUXÓMETRO

52740

624,00€

24

1

10



1560mm

520mm

280mm



HALÓGENO / XENON  
/ LED

- Distância de medição: 50cm.
- Fácil medição de desviação do eixo óptico dos médios e dos máximos.
- Guias laterais opcionais.
- Também para caminhões.



## ALINHADOR DE FARÓIS COM DUPLO LASER E LUXÓMETRO

52836

1.100,00€

24,85

1

10



270mm

520mm

1560mm



HALÓGENO / XENON / LED

REGULAMENTO  
ECRÃ DE VERIFICAÇÃO



LUXÓMETRO  
DIGITAL



DUPLO LASER



## BALIZA DE EMERGÊNCIA LED

53721

18,80€

0,16

20

80

1.440



HOMOLOGAÇÃO: DGT  
LCOE 2019050378G1

ÚTIL EM QUALQUER SITUAÇÃO

- Resistente ao vento **180 Pa**.
- Resistente à água **IP 54**.
- Resistente à poeira.
- Temperatura de trabalho: **-20°C a 50°C**.

COM GRANDE VISIBILIDADE

- **24 LED de 0.5W** (luz laranja) + **9 LED de 0.2W** (luz branca).
- Intensidade da luz: **40-80 CD**.
- Frequência: **0,82 Hz**.
- Ângulo superior: **-8° a 8°**.

MODOS DE LUZ

- Inclui 2 modos de luz: **flash de emergência laranja** + função de **iluminação com luz branca**.

SEM CABO

- Inclui pilha **6LR61 9V**.
- **Tempo de trabalho:**  
Laranja FLASH (24 horas)  
Luz branca (5 horas).



x9 LED  
1.8W  
5H

x24 LED  
12W  
24H

Com indicador de estado da bateria



Magnético



Ampla  
visibilidade



Pequeno, leve e fácil  
de manusear

BASE MAGNÉTICA



40-80  
cd

180Pa

IP  
54

0.82Hz

-8°  
8°

ABS

-20°C  
50°C

9V  
450mA

6500±400  
KELVIN

1700±200  
KELVIN

Apresentação em  
expositor de 20  
unidades

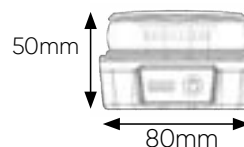



## PIRILAMPO LED BASE FLEXÍVEL

**52456**

32,75€

0,59

20

160



- Lente ABS-BAES.
- Tulipa anti-rotura.
- Consumo: 8W.

- Funções:
- Função 1: ROTAÇÃO
- Função 2: DUPLO FLASH
- Função 3: 6 FLASH



LED 6  
EN 1



BASE  
FLEXÍVEL

Ø 24mm

240mm  
Ø 128mm  
12-24V

ECE R10 CE

## PIRILAMPO LED 12-24V BASE FLEXÍVEL

**53690**

32,85€

0,60

20

200



- Funções:
- Função 1: FLASCH
- Função 2: DUPLO
- Função 3: ROTAÇÃO



ECE R10  
ECE R65



## PIRILAMPO LED MAGNÉTICO

**53691**

32,85€

0,70

20

320



- Funções:
- Função 1: FLASCH
- Função 2: DUPLO
- Função 3: ROTAÇÃO



ECE R65 ECE R10

## PIRILAMPO SEM CABO

**51962**

23,00€

0,58

20

240



12V  
55W

- Lente ABS - BAES.
- Tulipas anti-rotura.
- Filo da lente com soldadura de durabilidade.
- Rpm: 40.
- Sistema de pinhão / Senfim.
- Lâmpada:
- H1, 12V 55W
- H1, 24V 70W
- Consumo de corrente: 3.0 A.

**51963**

27,00€

0,59

20

240



24V  
70W

155mm  
Ø 140mm  
ECE R10  
ECE R65  
CE



## PIRILAMPO BASE FLEXÍVEL

**51964**

26,50€

0,69

20

160



12V  
55W

**51965**

27,50€

0,68

20

160



24V  
70W

240mm  
Ø 128mm  
ECE R10  
ECE R65  
CE

- Cúpula anti-chock.
- Lente ABS - BAES.
- Fio da lente com soldadura de durabilidade.
- Rpm: 40.
- Sistema de pinhão / Senfim.
- Lâmpada:
- H1, 12V 55W
- H1, 24V 70W
- Com base de rosca.
- Consumo de corrente : 3.0 Amp.

BASE  
FLEXÍVEL



## FARO TIPO FLASH

**51966**

18,00€

0,31 50 750



12V  
110V

131mm

Ø 99mm

Ø 61mm

- Lente ABS - BAES.
- XENON.
- Consumo de corrente: 3.0 A.

BASE TULIPA  
ROSCADA



ECE R10

## PIRILAMPO TIPO FLASH DE LEDS PERFIL BAIXO

**52827**

45,50€

**52910**

39,00€

**52946**

41,50€

**52828**

42,50€



0,44 20 320



- Com 3 interruptores de função.
- 3 modos piscar:
  - Rotação
  - 6 Flashes
  - Duplo Flash



## PIRILAMPO COM CABO IMANTADO

**51960**

29,80€

0,80 20 240



12V

55W



170mm

Ø 140mm

**51961**

29,80€

0,78 20 240



24V

70W

- Lente ABS - BAES.
- Tulipas anti-rotura.
- Filo da lente com soldadura de durabilidade.
- Rpm: 40.
- Sistema de pinhão / Senfim.
- Lâmpada:
  - H1, 12V 55W
  - H1, 24V 70W
- Cabo: Aspiral de 3m + tomada de isqueiro.
- Consumo de corrente: 3.0 A.



ECE R10  
ECE R65



## PIRILAMPO LED MÓDULO P/PISCAR

**52375**

35,25€

0,68 20 240



12-24V

- Lente ABS-BAES.
- Tulipa anti-rotura.
- Cabo: Aspiral de 2,5m +tomada de isqueiro.
- Consumo: 9W.

- Funções:
  - Função 1: ROTACÃO
  - Função 2: DUPLÔ FLASH
  - Função 3: 6 FLASH

170mm

Ø 140mm



LED 6 EN 1



## CONECTORES PARA PIRILAMPO

PARA REF. 51964, 51965,  
52300, 52456, 52549, 53131

**10750**

13,00€

0,25

50



PARA REF. 51964, 51965,  
52300, 52456, 52549, 53131

**10751**

15,00€

0,33

50

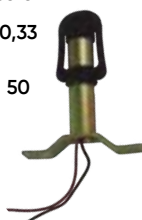

PARA REF. 51966

**11103**

5,50€

0,01

1



PARA REF. 51960, 51962, 51964

**10766**

2,80€

0,02

10

200



## CABO EXTENSÍVEL MULTIFUNÇÃO

**52843**

27,00€

1,03 20 1.500

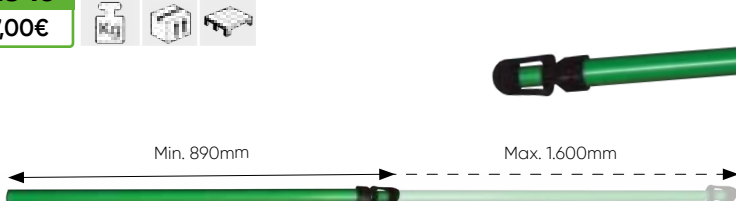



## CÚPULA DE PIRILAMPO PARA REF. 51960, 51962, 51964

<b>51969</b> 14,00€	0,12 Kg	50 Unid	<b>11324</b> 17,50€	0,13 Kg	50 Unid	<b>11325</b> 17,50€	0,12 Kg	50 Unid	CÚPULA ANTI-SHOCK.
------------------------	------------	------------	------------------------	------------	------------	------------------------	------------	------------	--------------------

120mm  
Ø 128mm



## AVISADOR ACÚSTICO 12V-80V

<b>51967</b> 15,80€	0,3 Kg	10 Unid	50 Unid	1.200 Unid	80mm	113mm	50mm	12V 80V
------------------------	-----------	------------	------------	---------------	------	-------	------	------------

<b>51968</b> 15,80€	0,23 Kg	10 Unid	50 Unid	1.000 Unid	80mm	113mm	50mm
------------------------	------------	------------	------------	---------------	------	-------	------



51967

51968

- 97 dB.  
- Resistente a diversas condições climáticas.  
- Possibilidade de ser lavado com água a pressão.

- Protegido frente a polaridades inversas.  
- Soldado com resinas epoxi.  
- Temperaturas suportadas: de -30 a 70°C.



## LUZ DE SEGURANÇA PARA EMPILHADEIRA

<b>53516</b> 59,00€	0,7 Kg	20 Unid	300 Unid	<b>54078</b> 64,50€	0,7 Kg	20 Unid	300 Unid
------------------------	-----------	------------	-------------	------------------------	-----------	------------	-------------

10V  
30V

10V  
60V

95mm  
150mm  
115mm

Luz de segurança oval com 2 LEDs azuis. A luz é projetada no solo com uma luz azul direcional como um aviso para pedestres na área.

Esta luz de aviso permite evitar colisões e acidentes entre empilhadores e pessoas, e aumenta a segurança em condições de trabalho, especialmente em pontos cegos. Perfeito para ambientes ruidosos.



Suporte universal



## FAROL AUXILIAR LED LUZ DISPERSA

<b>53428</b> 14,00€	0,5 Kg	5 Unid	20 Unid	480 Unid	126mm	108mm	48mm
------------------------	-----------	-----------	------------	-------------	-------	-------	------

<b>53429</b> 14,00€	0,4 Kg	5 Unid	20 Unid	480 Unid	128mm	Ø115mm	48mm
------------------------	-----------	-----------	------------	-------------	-------	--------	------

1.800 Lm  
9V  
30V  
x9 LED  
27W  
LED  
6000 KELVIN  
AL  
IP 67



## FAROL AUXILIAR LED LUZ DISPERSA

**52566** 1,09 10 360  

23,95€   

**52567** 1,02 10 400  

23,95€   

## FAROL AUXILIAR LED LUZ CONCENTRADA

**52568** 1,17 10 400  

23,95€   

**52569** 1,04 10 400  

23,95€   





## FAROL AUXILIAR LED LUZ DISPERSA

**52302** 0,84 5 20 640  

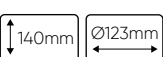
19,60€   



**52303** 0,76 5 20 640  



19,60€   

## FAROL AUXILIAR LED LUZ CONCENTRADA

**52415** 0,84 5 20 640  

15,90€   

**52414** 0,76 5 20 640  

15,90€   





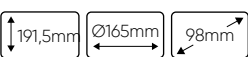

## FAROL AUXILIAR LED LUZ CONCENTRADA

**53051** 2,75 6 468  

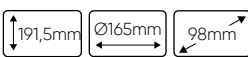
136,40€   

## FAROL AUXILIAR LED LUZ DISPERSA

**53052** 2,75 6 468  

136,40€   

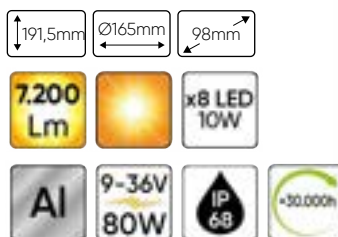



## FAROL AUXILIAR LED LUZ CONCENTRADA

**53048**

78,60€

1,5 10 1.000



118mm 123mm 87mm

3.600 Lm x4 LED 10W

AI 9-36V 40W IP 68 ~30.000h

## FAROL AUXILIAR LED LUZ CONCENTRADA

**53047**

265,35€

3,51 4 40



230mm 185mm 150mm



3.200 Lm x10 LED 5W

AI 12-24V 80W IP 67

~30.000h 280cm

## FAROL AUXILIAR LED LUZ DISPERSA

**53049**

78,60€

1,53 10 468



118mm 123mm 87mm

3.600 Lm x4 LED 10W

AI 9-36V 40W IP 68 ~30.000h

## FAROL AUXILIAR LED LUZ DISPERSA

**53045**

35,00€

1 12 504



155mm 127mm 55mm

2.880 Lm x16 LED 3W

AI 9-36V 46W IP 68 ~30.000h

## FAROL AUXILIAR LED LUZ DISPERSA

**53046**

34,00€

0,74 12 480



139mm 128mm 48,5mm



2.272 Lm

x16 LED 1,5W AI

9-36V 24W IP 68 ~30.000h

## CONJUNTO DE DUAS LUZES TRASEIRAS MAGNÉTICAS SEM FIO

**54044**

88,00€

1,1 6

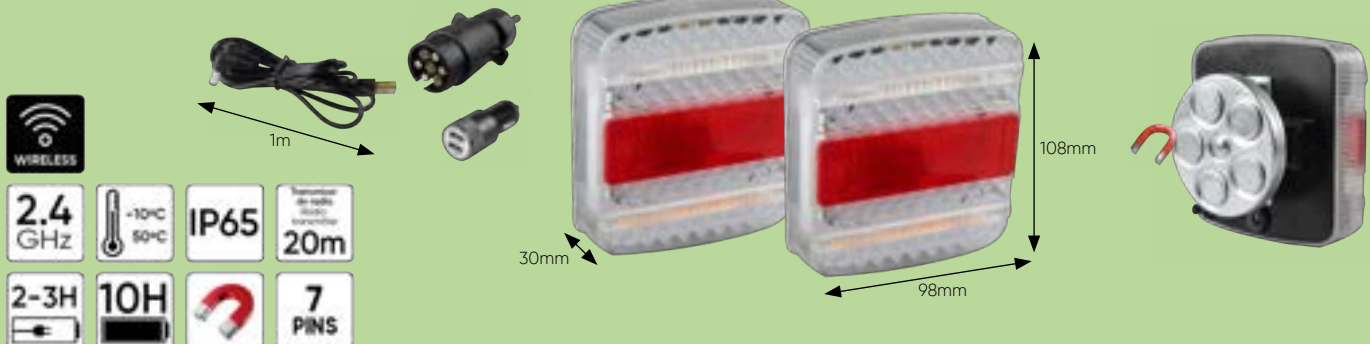

WIRELESS

2.4 GHz -10°C 50°C IP65 20m

2-3H 10H 7 PINS

1m

30mm

108mm

98mm

## BARRA DE SINALIZAÇÃO PARA REBOQUE DE 1,4 A 2,1m CABO DE 6m

**52458**  
53,35€

3,45 6 36

**7 PINS**  
1.400mm  
1.210mm

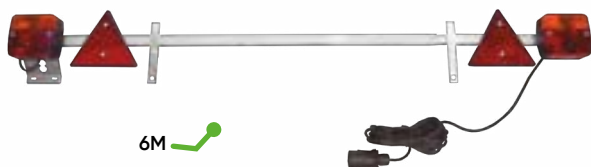

**52848**  
75,60€

2,49 1 6 36

**12V LED**

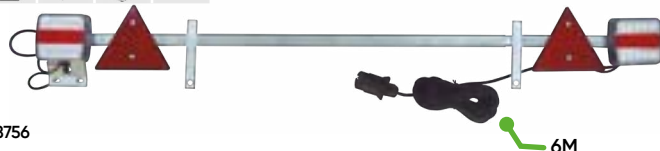

Aprovado E4 7R-0218756

## SINALIZADOR LED PARA BARRA DE REBOQUE

**53151**  
12,50€

0,2 5 20 900

**12V**



99mm  
100mm  
39mm

- 4 funções:
- Azul: Posição e matrícula.
- Vermelho: luz de freio.
- Amarelo: Parpadeante.
- Branco: Massa.

## BARRA DE SINALIZAÇÃO PARA REBOQUE 2 FAROLINS, 2 TRIÂNGULOS REFLECTORES CABO DE 5m

**50910**  
45,00€

2,14 6 54

**52838**  
56,00€

1,96 1 6 54

**12V LED**

Aprovado E4 7R-0218756

Material: HDPE  
140mm  
1100mm

**7 PINS**



## KIT MAGNÉTICO COM 2 FAROLINS 2 TRIÂNGULOS REFLECTORES

**51886**  
44,00€

1,47 8 96

**52839**  
57,00€

1,47 8 96

**12V LED**

Aprovado E4-7R-0218756

118mm  
123mm  
87mm

Cabo liso: 7m  
Cabo espiral: 2,5m

**7 PINS**



## COMPROBADOR DE LUZES DE REBOQUE 7/13 PINOS

**53536**  
28,05€

0,2 26 1.144

**7-13 pinos**  
**9V**



**EXTENSÃO DE 7 PINOS**  
**14753**  
13,00€

0,20 50

- Este testador tem um soquete de 13 pinos em cada extremidade para ser conectado ao reboque e ao plugue do carro.  
- Ele indica rapidamente se há danos na fiação do carro e do trailer.  
- Também é útil para verificar caravanas e suportes de

bicicletas.  
- Tem duas saídas, uma para a saída do veículo e outra para a entrada do reboque.  
- Inclui um adaptador de 13 a 7 pinos.  
- PILA 9V.

13 PINOS

7 PINOS



- Ficha de 7 pinos e tomada de 7 pinos  
- Tamanho do cabo: 20cm x 0,5mm<sup>2</sup>

## COMPROBADOR DE LUZES DE REBOQUE 7 PINOS

**51929**  
21,00€

0,2 26 1.144

**7 pins**  
**9V**



- Este comprobador tem uma toma em um lado para conectar el enchufe de 7 pinos do reboque e no outro para conectar a tomada a 7 pinos do carro.  
- Este comprobador indica rapidamente si há estragos nos cabos tanto do carro como do reboque.

- Também útil para a comprovação de caravanas e suportes para bicicletas.  
- Dispõe de duas saídas, uma para a tomada de saída del veículo e outra para a tomada de entrada de reboque.

TOMADA REBOQUE

TOMADA VEÍCULO



## MINI ESTUCHE DE LÂMPADAS

0,09 10 100 1.800



12V H9



**51615**  
6,80€



12V H11



**51612**  
6,80€



12 V HB3



**50523**  
4,50€



12V HB4



**50524**  
4,50€



12V H7+H1



**50915**  
5,40€



12 V H1



**51613**  
3,80€



H4



**51614**  
4,50€



**52047**  
4,50€



H7



**50431**  
4,80€



**52048**  
5,00€



## ARMÁRIO DE LÂMPADAS PARA TURISMOS

**50551**

330,00€

9,39

1

18



### Stop de 1 Polo

P21W 21 W BA15s 30u.  
P21WA 21 W BA15s Ambar / 10u.  
PY21W 21 W BAU15s  
Com desc. / 10u.

### Stop de 2 Polos

R21/5 W 21/5 W BAY15d 40u.  
PLAFONIER  
C5W 5 W SV8.5 11x38 22u.

### Lâmpadas Piloto

R5W 5 W BA15s 30u.  
R10W 10 W BA15s 30u.

### Lâmpadas indicadoras

T4W 4 W BA9s 22u.

### Lâmpadas Halógenas

H1 55 W P14.5s 10u.  
H2 55 W X511 4u.  
H3 55 W PK22s 4u.  
H4 60/55 W P43t 10u.  
H7 55 W PX26d 10u.  
HB3 65 W P20d 4u.  
HB4 55 W P20d 4u.  
H9 65 W PGJ19-5 4u.  
H11 65 W PGJ19-2 4u.

### Foco Europeu

T5 12 W W2,1x4,6d 20u.  
T10 5 W W2,1x9,6d 12u.  
T10 3 W W2,1x9,6d 12u.  
T13 10 W W2,1x9,6d 10u.  
T15 18 W W2,1x9,6d 10u.  
T20 21 W W5x16d 10u.  
T20A 21 W W5x16d Ambar 10u.  
T20 21/5 W W5x16d 10u.

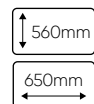



## H7

**52365** 0,01 10 200 9.000  
**3,42€**  
 12V  
 55W

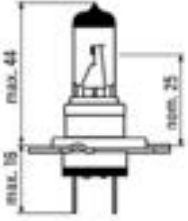

## H1 55W

**10766** 0,02 10 200  
**2,80€**  
 12V  
 55W

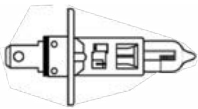

## H4

**52364** 0,02 10 200 4.400  
**3,92€**  
 12V  
 60-55W

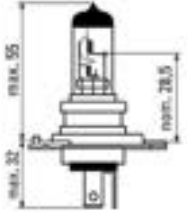

## H3

**52363** 0,02 10 200 14.400  
**1,68€**  
 12V  
 55W

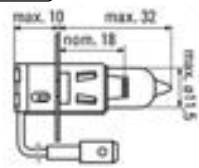

## H1

**52362** 0,01 10 200 14.400  
**1,68€**  
 12V  
 55W

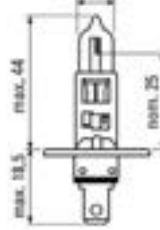

## 1 POLO

**52366** 0,01 10 200 14.400  
**0,57€**  
 12V  
 21W

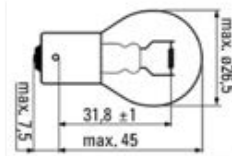

## BA15S

**53203** 0,1 10 200  
**0,50€** AMBER  
 12V  
 21W

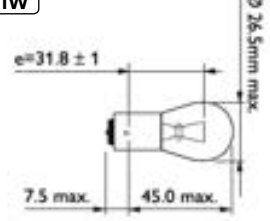

## 2 POLOS

**52367** 0,01 10 200 14.400  
**0,57€**  
 12V  
 21/5W

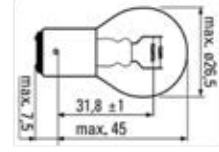

## 2 POLOS

**52369** 0,01 10 1.000 18.000  
**1,62€**  
 12V  
 21-55W

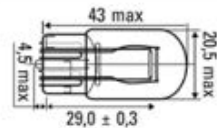

## PLAFONIER

**52371** 0,01 10 2.000 24.400  
**0,50€**  
 12V  
 5W

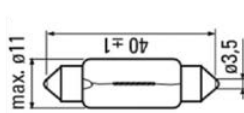

## WEDGE T10

**52861** 0,01 10 5.000  
**0,50€**  
 12V  
 5W

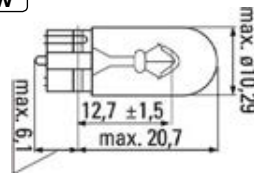

## WEDGE T20

**52862** 0,01 10 1.000  
**1,80€**  
 12V  
 21W

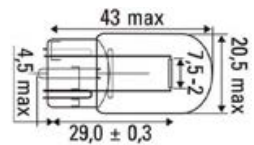

## WEDGE T20

**52863** 0,01 10 1.000  
**1,80€** AMBER  
 12V  
 21W

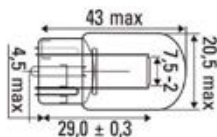

## R5W

**53007** 0,01 10 200  
**0,50€**  
 5V  
 12W

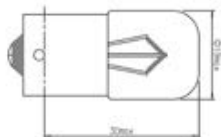

## BAU15S

**52867** 0,01 10 1.000  
**1,00€** AMBER  
 12V  
 21W

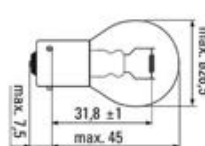

## T20A

**52368** 0,01 10 1.000 18.000  
**1,56€**  
 12V  
 21W

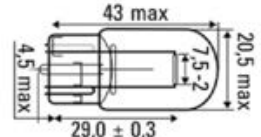

## T20

**52370** 0,01 10 1.000 18.000  
**1,59€**  
 12V  
 21W

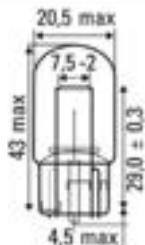

## T20

**52864** 0,01 10 1.000  
**1,80€**  
 12V  
 21/5W

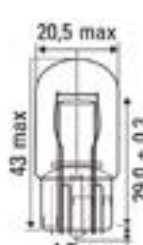

## T13

**52865** 0,01 10 2.000  
**0,50€**  
 12V  
 10W

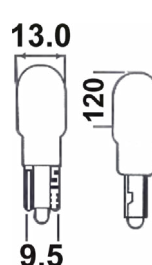

## T15

**52866** 0,01 10 2.000  
**0,50€**  
 12V  
 18W

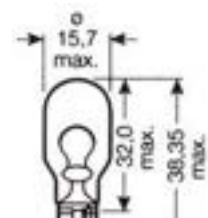

LÂMPADAS DE VEÍCULOS

PISTOLAS DE IMPACTO

130-136-140



PARA CAMINHÃOS

132



MÁQUINA DE FURAR

133-137-141



AMOLADORA

133-135-137-141



ROQUETE

133-140



REBARBADORA

134-137-142



LIXADEIRA

139



PULIDORAS

139



DESTANOLADOR DE PNEUS / POLIMENTO VALVULAS

138



DISCOS / EXPOSITORES

142



PISTOLAS DE AR

143



FILTROS / ÓLEO PARA FERRAMENTA PNEUMÁTICA

144



PISTOLAS VARIAS

145



CARRETEL DE MANGUEIRA DE AR

146



MANGUEIRA DE AR

147



ADAPTADOR / ENGATE

147

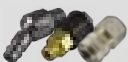

# FERRAMENTAS PNEUMÁTICAS



SERIE124

## PISTOLA DE IMPACTO 1/2" COMPOSITE

**53520**

228,00€



**1756Nm**

COMPOSITE



KIT DE REPARAÇÃO PARA PISTOLA 53520

**14121**

26,00€



## PISTOLA DE IMPACTO MODELO NANO 1/2"

**53588**

152,00€



**1302Nm**



KIT DE REPARAÇÃO PARA PISTOLA 53588

**14165**

26,50€



## PISTOLA DE IMPACTO MINI DE 1/2" COMPOSITE

**51206**

209,00€



**1302Nm**

COMPOSITE



KIT DE REPARAÇÃO PARA PISTOLA 51206

**14120**

22,00€



## KIT PISTOLA IMPACTO COMPOSITE 1/2" COMPOSITE + CHAVES

**51207**

264,00€

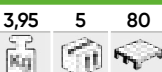

COMPOSITE

**1756Nm**



17, 19, 21mm

KIT DE REPARAÇÃO PARA PISTOLA 51207

**14121**

26,00€





## PISTOLA DE IMPACTO DE 3/4" COMPOSITE

**51212** 3,77 4 60  
448,00€

**2034Nm**

COMPOSITE



KIT DE REPARAÇÃO PARA PISTOLA 51212

**14122** 1,12 20  
34,00€

## PISTOLA DE IMPACTO DE 1" COMPOSITE

**51211** 3,86 4 60  
498,00€

**2034Nm**

COMPOSITE



KIT DE REPARAÇÃO PARA PISTOLA 51211

**14123** 1,16 20  
33,00€

## PISTOLA DE IMPACTO DE 3/4" + ALARGADOR 15cm COMPOSITE

**51210** 4,49 4 60  
560,00€

**2034Nm**

COMPOSITE



KIT DE REPARAÇÃO PARA PISTOLA 51210

**14122** 1,12 20  
34,00€

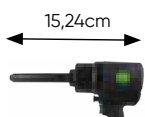

## PISTOLA DE IMPACTO DE 1" + ALARGADOR 12cm COMPOSITE

**51213** 4,77 4 60  
599,00€

**2034Nm**

COMPOSITE



KIT DE REPARAÇÃO PARA PISTOLA 51213

**14123** 1,16 20  
33,00€

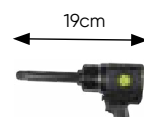

## PISTOLA DE IMPACTO 1/2" COMPOSITE

**53689** 2,10 5 10 140  
230,00€

**1950Nm**

COMPOSITE

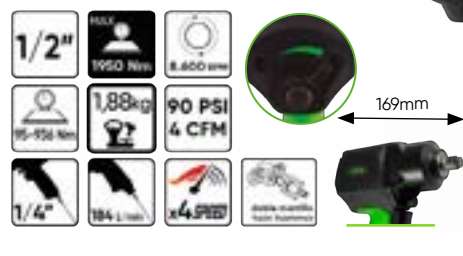

KIT DE REPARAÇÃO PARA PISTOLA 53689

**14618** 0,05 20  
19,00€

VELOCIDADE E POTÊNCIA AJUSTÁVEIS COM UMA SÓ MÃO

## PISTOLA DE IMPACTO 1/2"

**53726** 2,35 10 240  
118,00€

**1650Nm**

COMPOSITE



JBM RECOMENDA O USO DE SEUS ÓLEOS LUBRIFICANTES PARA OTIMIZAR O DESEMPENHO E AMPLIAR A VIDA ÚTIL DA FERRAMENTA

EM PAG.144

**14534**  
600ML



**14560**  
100ML



## PISTOLA DE IMPACTO

1/2"

**53733**

1,30 5 10

227,00€



**650Nm**

## PISTOLA DE IMPACTO

1/2"

**53608**

2,35 5 10 300

88,00€



**1200Nm**



KIT DE REPARAÇÃO PARA PISTOLA 53733

**14633**

0,75 20

22,50€



KIT DE REPARAÇÃO PARA PISTOLA 53608

**14583**

0,05 10

6,00€



## PISTOLA NEUMÁTICA PARA RODA DE CAMINHÃO 1"

**52814**

23,5 1 20

528,00€



- Saída de ar lateral.  
- Fácil de aperto e afrouxamento  
regulação de velocidade.

**3260Nm**

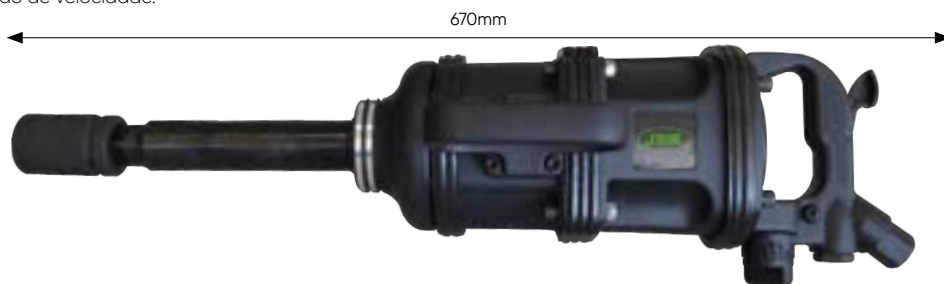
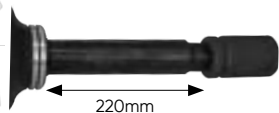

KIT DE REPARAÇÃO PARA PISTOLA 52814

**14153**

0,1 10

20,50€



## CHAVE DE IMPACTO PARA CAMINHÕES 1" - ULTRA LIGEIRA

**53681**

7,98 2 50

742,50€



**2441Nm**



KIT DE REPARAÇÃO PARA PISTOLA 53681

**14336**

58,00€



## MAQUINA DE FURAR ÂNGULO 90° 3/8"

**51221**

1,27 10 120

178,00€



- Reversível de ambos lados.
- Acabado em borracha.



KIT DE REPARAÇÃO  
PARA PISTOLA 51221

**14130**

0,01 10

21,00€



## MINI RECTIFICA DE 3/8" 6mm

**51245**

0,60 5 20 240

99,00€



160mm



KIT DE REPARAÇÃO  
PARA PISTOLA 51245

**14135**

0,01 10

12,50€



## KIT ROQUETE MULTI-FUNÇÃO 1/4" DE CABEÇA ABERTA COMPOSITE

**51225**

0,89 10 120

198,00€



COMPOSITE

**40,7Nm**

- Kit inclui:  
Peça convertidora de 1/4" a 3/8".  
Cabeça para Pontas de 1/4".  
Kit 2 pontas lisas + 2 Pontas estrela.



KIT DE REPARAÇÃO  
PARA PISTOLA 51225

**14132**

0,01 10

21,50€



## MÁQUINA DE FURAR 1/2" COMPOSITE

**51220**

1,64 10 120

210,00€



COMPOSITE

- Reversível de ambos lados.



KIT DE REPARAÇÃO  
PARA PISTOLA 51220

0,01 10

**14129**

12,50€



## ROQUETE MINI DE 1/2" COMPOSITE

**53784**

0,55 5 20

144,00€

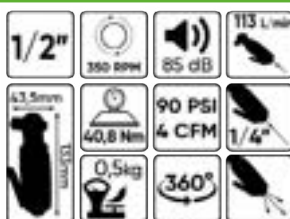

COMPOSITE



KIT DE REPARAÇÃO  
PARA PISTOLA 53784

**14779**

0,05 10

33,00€



## ROQUETE MINI DE 1/4" COMPOSITE

**51214**

0,52 20 240

138,00€



COMPOSITE



KIT DE REPARAÇÃO  
PARA PISTOLA 51214

**14124**

0,25 10

20,50€



JBM RECOMENDA O USO DE SEUS ÓLEOS  
LUBRIFICANTES PARA OTIMIZAR O DESEMPENHO  
E AMPLIAR A VIDA ÚTIL DA FERRAMENTA

EM PAG.144

**14534**  
600ML



**14560**  
100ML





## ROQUETE DE 1/2"

51215

1,33 20 240

99,00€

- Rotação de ar de admissão e escape.
- Regulador de Ar.



KIT DE REPARAÇÃO PARA 51215

14125

19,50€

0,33 10



## KIT REBARBADORA PNEUMÁTICA COM SAÍDA TRASEIRA

51227

2,03 10 120

193,00€

- Punho em borracha.
- Maior aderência.
- Desenho MINI.
- Inclui óculos, Palancas, allen e 10 discos de 3".

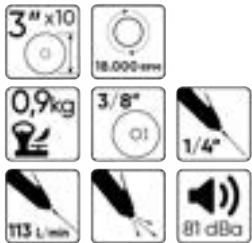

REPOSIÇÃO EM PAG. 142



KIT DE REPARAÇÃO PARA PISTOLA 51227

14134

17,50€

0,01 10



## KIT MINI REBARBADORA

51226

1,52 10 120

233,00€

- Punho em borracha.
- Maior agarre.
- Designo MINI.
- Inclui óculos, resguardo e discos.

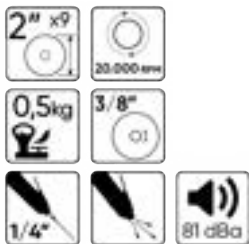

REPOSIÇÃO EM PAG. 142

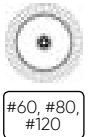

KIT DE REPARAÇÃO PARA PISTOLA 51226

14133

16,50€

0,01 10



## MÁQUINA PNEUMÁTICA P/ MON-TAR FOLES DE TRANSMISSÕES

51861

4,08 1 2 32

199,00€

- Material: Alumínio.
- Abertura de 20 a 100mm.



## REBARBADORA

51219

2,1 5 10 120

221,50€

- Acabado em borracha.
- Maior aderência.
- Alavanca de segurança 8 posições.

400mm



RESGUARDO ANTI CHISPAS

KIT DE REPARAÇÃO PARA 51219

14128

13,50€

0,01 10



# REBARBADORA ORBITAL COMPOSITE

COMPOSITE

**51218** 2,27 5 10 120  
**248,00€**

- Acabado em borracha.
- Maior aderência.
- Alavanca reversível.

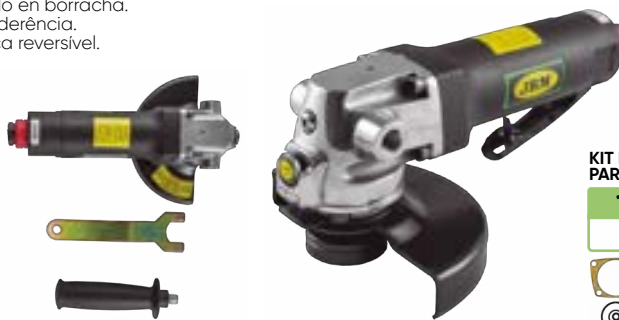

KIT DE REPARAÇÃO PARA PISTOLA 51218

**14127** 0,01 10  
**32,50€**



## KIT PULIDORA

**51216** 4,33 4 16  
**548,00€**



19 PCS

- Proteção do Usuário de chispas.
- Adaptador (patentado).
- Cabo anatômico.
- Seguridade no acelerador de resguardo.

- Inclui:  
 Distintos tipos de rodas (para a preparação de superfícies metálicas consoante o tipo de trabalho).  
 11mm - escova de arame (fino).  
 23mm - escova de arame (fino).  
 11mm - escova de arame (grosso).  
 23mm - escova de arame (grosso).  
 Apagador de borracha.

Apagador de pinturas com base de água.  
 Adaptador de 23mm para apagador.  
 De borracha e escova de arame.  
 Adaptador de 11mm da escova de arame.  
 Pulidor pedro de borracha dura (até 6 peças).  
 Adaptador único do pulidor de borracha dura.  
 Adaptador de dupla tira de borracha dura.  
 Allen.

## ACCESÓRIOS

SUPORTES 25,00€/u.

Para roda de 23mm

**51439**  
 0,12 50 800



Para roda de 11mm

**51440**  
 0,1 1 800



Roda preta duplo

**51441**  
 0,1 1 800



Roda preta simple

**51442**  
 0,1 1 800



LAMELAS 18,00€/u.

Lamela grossa ângulo de 23mm

**51388**  
 0,08 100 800



Grossa ângulo 11mm

**51389**  
 0,05 1 800



Lamela fina lisa 23mm

**51390**  
 0,01 1 800



Lamela fina lisa 11mm

**51391**  
 0,04 1 800



CABO ANATÓMICO

1,2kg

LAMELAS DE PINTURA

25,00€/u.

**51392**  
 0,1 1 800



Lamela de pintura Ø105mm



**51393**

Lamela de pintura com água Ø105mm

**14126**

46,50

0,01 10

KIT DE REPARAÇÃO PARA PISTOLA 51216



## VENTOSA AR PARA DENTS

**52540** 4,69 3 72  
**220,50€**

- Ventosa com martelo pneumático desli-zante para tirar mossas.
- O seu desenho permite tirar mossas de uma maneira rápida e fácil.



JBM RECOMENDA O USO DE SEUS ÓLEOS LUBRIFICANTES PARA OTIMIZAR O DESEMPENHO E AMPLIAR A VIDA ÚTIL DA FERRAMENTA

EM PAG.144

**14534**  
 600ML



**14560**  
 100ML



## PISTOLA DE IMPACTO DE 1/2" DOBLE BLISTER

**51222** 1,09 20 240  
121,50€

**101Nm**



KIT DE REPARAÇÃO  
PARA PISTOLA 51222

**14131** 0,01 10  
24,00€



MECANISMO  
"BORBOLETA"

## PISTOLA DE IMPACTO DE 1/2" COMPOSITE

**52767** 2,66 10 160  
328,00€

**1492Nm**

COMPOSITE

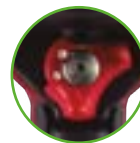
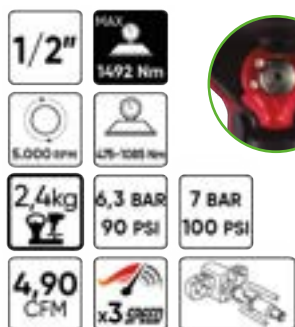

## PISTOLA IMPACTO 3/4"

**53343** 7,9 2 96  
285,00€

**1600Nm**

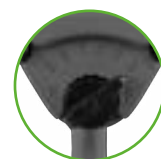

## PISTOLA IMPACTO 1"

**53344** 8,05 2  
295,00€

**1600Nm**



## MINI AMOLADOR 1/4" COMPOSITE

**53137** 0,32 5 20  
38,00€





## BROCA PNEUMÁTICA 1/4" COMPOSITE

53141

65,50€

0,55 4 60



## AMOLADORA ANGULAR PNEUMÁTICA

52528

42,50€

0,69 5 20 960



- Corpo fabricado em alu.  
- Com recubrimento de goma.  
- Fácil manuseio e ligero.



GATILHO DE SEGURIDADE INCORPORADO

## SERRA PNEUMÁTICA

52574

64,00€

0,73 4 20 640



- 2 serras recambio 95mm - 32 dentes.  
- 2 chaves ALLEN.  
- 1 protetor de Serra.

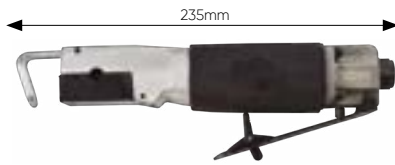

5 LÂMINAS DE SERRA 24 DENTES

11956

5,50€

0,03 10 300



5 LÂMINAS DE SERRA 32 DENTES PARA FERRO

11957

5,50€

0,01 200



## MÁQUINA DE REBITES DE AR

52575

99,50€

1,71 5 10 200



2,4mm (3/32), 3,2mm (1/8)  
4,0mm (5/32), 4,8mm (3/16)

- Tamanho: 3/16" - 5/32" - 1/8" - 3/32".  
- Tração: 1586lbs / 720 kgs.  
- Rod: 9/16" - 14mm.  
- Binário max. 60FT LB / 23-69NM.  
- Entrada de ar: 1/4".  
- Consumo de ar médio: 0.03Cfm/0.86L/min.

Inclui:  
- 2 Multi-tool  
- Quick  
- O-rings



## TESOURA PNEUMÁTICA METÁLICA

53541

144,50€

1,6 5 10



- Tesoura pneumática profissional ideal para corte de alumínio, outros metais, borracha e plásticos em geral, com capacidade de corte de 1,02mm.  
- Agarre de ferramenta ergonômico para uso confortável e gatilho fácil de usar.  
- Permite cortar em linha reta, em ângulo ou em círculos, sem deformação das bordas.



KIT DE REPARAÇÃO PARA PISTOLA 53541

14136

12,00€

0,01 5



## CORTADORA PNEUMÁTICA COMPOSITE

53140

95,00€

0,99 14 400



DISCO DE SUBSTITUIÇÃO PARA REF. 53140

0,1 500



14013

3,50€

## MÁQUINA FURAR PARA SOLDADURA DESPLAZA O FURO CENTRAL

52724

330,00€

2,55 6 84



52725

298,00€

2,35 10 180



PONTA PARA REF. 52725 E 52724

13817

17,00€



0,1 500



6,5mm

13818

20,50€

0,1 500



8mm

JBM RECOMENDA O USO DE SEUS ÓLEOS LUBRIFICANTES PARA OTIMIZAR O DESEMPENHO E AMPLIAR A VIDA ÚTIL DA FERRAMENTA

EM PAG.144

14534 600ML



14560 100ML



## DESTANOLADOR PNEUMÁTICO DE PNEUS

53542

876,50€



- Destanador de jantes pneumático profissional especialmente projetado para aplicação em veículos agrícolas, industriais e a maioria dos caminhões.
- Extremamente rápido: economiza tempo em relação aos rompedores hidráulicos convencionais.
- Permite a desmontagem in situ no local de trabalho da máquina.
- Excelente para trabalhar sobre o pneu sem retirar a roda: solta o talão do pneu da jante com alavancagem.

PARA APLICAÇÃO EM VEÍCULOS AGRÍCOLAS/INDUSTRIAIS



- As especificações técnicas:  
Capacidade de abertura: 68mm.  
Extensão do pistão: 80mm.  
Entrada de ar: 1/4".  
Consumo de ar: 113 l/min.  
Comprimento: 396mm.  
Peso: 4,6 kg.  
10.000 RPM



KIT DE REPARAÇÃO PARA PISTOLA 53542

14137

130,50€



## FERRAMENTA PNEUMÁTICA POLIMENTO VÁLVULAS - PERCUSSÃO E ROTAÇÃO

53572

275,00€



- Conteúdo:  
1 x máquina pneumática para válvulas.  
5 x ventosa (16, 20, 30, 35 e 45 mm).  
5 x adaptador de válvula.  
Chave Allen de 1 x 3 mm.

REGULA A VELOCIDADE



16mm

14157  
7,50€



20mm

14158  
5,00€



30mm

14159  
11,00€



35mm

14160  
6,50€



40mm

14161  
12,00€

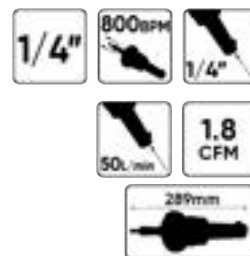

VIRAR À DIREITA +  
VIRAR À ESQUERDA

## FERRAMENTA DE SOBREPOSIÇÃO DAS VÁLVULAS DE PERFURAÇÃO

54033

49,00€



- Diâmetro ventosas: 16, 20, 30, 35, 40mm
- Conexión taladro: 8mm
- Longitud: 128mm
- Velocidad de trabajo máxima: 1250rpm



## SERINGA PNEUMÁTICA PARA SELAGEM

53567

40,00€



- Pressão de trabalho: 2,5-5 BAR.
- Entrada de ar: 1/4".
- Capacidade do cartucho: 310ml.



305mm

## EXTRACTOR DE FUMO

52824

573,50€



- Comprimento do tubo retrátil: 4m.
- Capacidade de sucção: 185 L/min.

- Extrator de fumaça de pneu, por conexão compressor de ar permite conexão direta com o tubo de escape para canalizar a saída de fumaça.

- Útil para a manutenção de ambientes de trabalho saudáveis e em certos casos em que o veículo não realiza combustão adequada e gera fumaça excessiva.

- Mangueira retrátil, permite o armazenamento dentro do corpo da bomba para economizar espaço de armazenamento.



## LIXADEIRA ORBITAL AUTO-ASPIRANTE

52676

93,00€

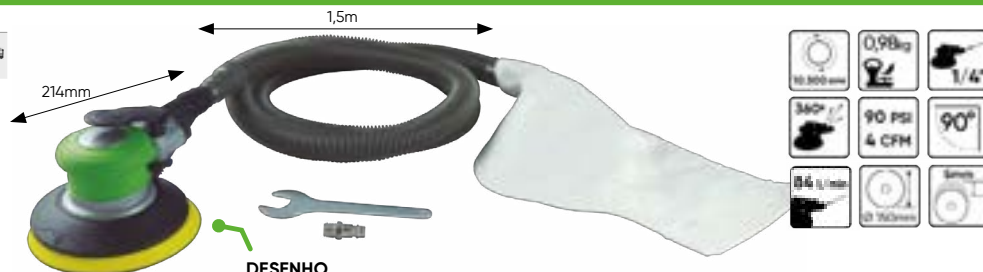

- Corpo de alumínio com punho gomado.  
- Excelente desempenho de limpeza com bolsa e mangueira.

DESENHO ERGONÓMICO

## LIXADEIRA ORBITAL ADAPTÁVEL ASPIRADOR

52675

79,00€



52758

78,00€



Corpo de alumínio com punho gomado



## LIXADEIRA ORBITAL

53136

163,00€



## DISCO PARA LIXADEIRAS

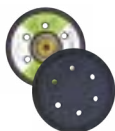

DISCO DE 6 BURACOS PARA 52675, 52758, 52676, 52376

12009

11,00€

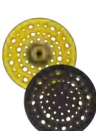

DISCO DE 66 BURACOS PARA 52675, 52758, 52676, 52376

13500

11,00€

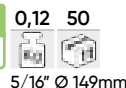

DISCO DE 15 BURACOS PARA 52675, 52758, 52676, 52376

13499

11,00€

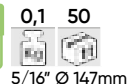

## 3" CONJUNTO PARA A MINIMÁQUINA DE POLIMENTO PNEUMÁTICA

53576

189,00€

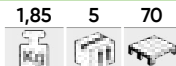

- O kit inclui:  
1x polidora pneumática de 3".  
1x disco de lixamento de velcro (instalado).  
1x chave para porca.  
3x esponjas de polimento com reverso de velcro.

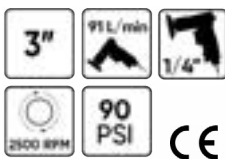

VELOCIDADE AJUSTÁVEL



ALMOFADA DE LÃ PARA REF. 53576

14162

22,00€



ALMOFADA ESPONJOSA DURA PARA REF. 53576 - AMARELA

14164

22,00€



KIT DE REPARAÇÃO

14154

37,00€



ALMOFADA ESPONJOSA MACIA PARA REF. 53576 - BRANCA

14163

21,50€



DISCO VELCRO PARA 53576

14330

3,50€



## 3" CONJUNTO PARA A MÁQUINA DE POLIMENTO PNEUMÁTICA

53646

61,50€



- O kit inclui:  
1x polidora pneumática de 3".  
1x disco de lixamento de velcro (instalado).  
1x chave para porca.  
3x esponjas de polimento com reverso de velcro.



ALMOFADA ESPONJOSA MACIA PARA REF. 53646

14286

3,00€



ALMOFADA ESPONJOSA DURA PARA REF. 53646

14287

3,00€



ALMOFADA DE LÃ PARA REF. 53646

14288

5,50€



DISCO VELCRO PARA 53646

14289

5,00€



JBM RECOMENDA O USO DE SEUS ÓLEOS LUBRIFICANTES PARA OTIMIZAR O DESEMPENHO E AMPLIAR A VIDA ÚTIL DA FERRAMENTA

EM PAG.144

14534  
600ML



14560  
100ML





## KIT DE RESTAURAÇÃO DE FARÓIS

53626

0,30 12 624

17,00€

Este kit é feito para restaurar **2 faróis**.

Projetado para restaurar a clareza das lentes dos faróis que ficaram amarelas, nubladas ou turvas. Melhora o desempenho das lentes dos faróis. Três passos simples: lixar, polir e proteger. Restaura faróis dianteiros, lanternas, faróis de neblina ou sinais de direção.



- Conteúdo del kit:  
2x P800 Discos de lixar.  
2x P1200 Discos de lixar.  
2x P2000 Discos de lixar.  
1x 85gm Pasta de polimento.  
2x 3.0ml Líquido protetor UV.

1x Fita adesiva.  
1x Disco de polimento de lã.  
1x Disco de Esponja Branco.  
1x Almofada de suporte M10 Rosca.  
2x Adaptador (3/8" & 1/4").



## KIT ESPECIAL POLIMENTO: MÁQUINA POLIMENTO NEUMÁTICA + 12 KIT RESTAURAÇÃO DE FARÓIS

SERIE262

214,50€



53626



## KIT FERRAMENTAS PNEUMÁTICA

PISTOLA DE IMPACTO + MARTELO NEUMÁTICO + ROQUETE NEUMÁTICO + MINI POLIDORA NEUMÁTICA + PISTOLA DE BUFAR + PISTOLA DE BUFAR RETA

52331

779 2 48

201,50€

1x Pistola de impacto 1/2"  
1x Martelo pneumático 150mm  
1x Roquete pneumático 3/8"  
1x Amoladora pneumática  
1x Mola de retenção  
1x Barra de extensão 1/2" - 75mm  
1x Galheta de óleo mini  
1x Chave hex. 4mm  
8x Chaves de impacto: 12, 13, 17, 19, 1/2", 9/16", 5/8", 11/16"  
1x Pistola de ar  
1x Mini pistola de ar  
1x Rolo de teflón  
4x Ponteiros 120mm  
2x Chaves fixas manuais  
5x Disco de lixado 1/4"  
5x Disco de lixar 1/2"  
5x Pedras de pulir 1/4"  
5x Pedras de pulir 3/8"  
2x Cilindros de lixar (3/4" e 1")  
1x Adaptador rápido fêmea  
1x Conector de ponteiro  
8x Pontas de bufar  
2x Adaptadores 1/8" para lixas  
1x Conector M-M conexão rápida  
1x Conector rápido M-H  
1x Boca de borracha  
1x Boca cônica  
1x Agulha de ar  
1x Boca de alta pressão  
1x Boca de seguridade  
1x Caixa de plástico



## KIT DE 16 CHAVES PNEUMÁTICAS COM PISTOLA 312Nm E ROQUETE 61Nm

52156

5,36 4 112

126,50€

9, 10, 11, 13, 14, 17, 19, 22, 24, 27mm

1/2"

16 PCS

PISTOLA DE IMPACTO:



ROQUETE PNEUMÁTICO:  
ADAPTADOR M / H

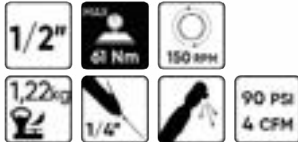

## PISTOLA DE IMPACTO DE 1/2"

52165

2,90 6 168

105,00€

610Nm



## ROQUETE PNEUMÁTICO DE 1/2"

52167

1,27 5 10 700

43,50€

61Nm



## MARTELO DE AGULHAS PNEUMÁTICO

53625

68,00€

2,15

5

10

- Velocidade de impacto:  
4500BPM  
- 19 agulhas  
- Peso: 1,97kg

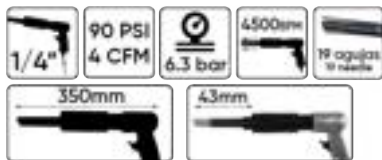

14188

0,50€

AGULHA PARA

REF. 53625

0,01 50 200



## MARTILLO PNEUMÁTICO

52718

48,00€

2,11

4

8

160



9  
PCS

## MÁQUINA DE FURAR REVERSÍVEL PNEUMÁTICA DE 1/2"

52159

54,50€

1,79

5

10

240



## BROCA PNEUMÁTICA DIRETA

53573

36,00€

0,75

5

20

- Compatível com brocas de 1,5 a 10 mm.



## MÁQUINA DE FURAR PNEUMÁTICA DE 3/8"

52160

42,00€

1,22

5

10

360



## MAQUINA DE FURAR 3/8" ÂNGULO 90°

52527

78,00€

1,22

5

10

480



## KIT DE 16 PEÇAS COM AMOLADORA PNEUMÁTICA

52157

48,00€

1

5

10

300



## MINI AMOLADORA PNEUMÁTICA DE 1/4"

52171

39,00€

0,42

10

20

1.080

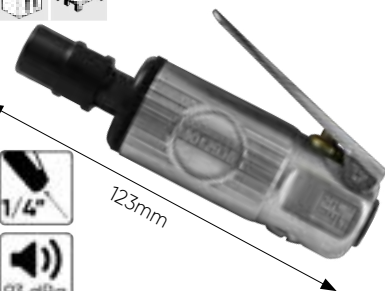

JBM RECOMENDA O USO DE SEUS ÓLEOS LUBRIFICANTES PARA OTIMIZAR O DESEMPENHO E AMPLIAR A VIDA ÚTIL DA FERRAMENTA

EM PAG.144

14534  
600ML



14560  
100ML



## CORTADOR PNEUMÁTICO 3"

52953

38,00€

0,9 5 20 1.500

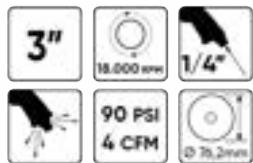
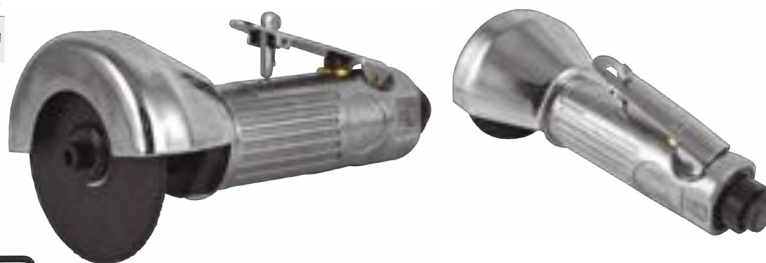

DISCO DE CORTE 3"  
PARA REF. 52953

12987

1,50€

0,02 50 500



## DISCOS DE CORTE

PARA REF. 51227

51387

2,50€

0,02 50 100 800



3"

Ø Interior: 9,53mm  
Ø Exterior: 75mm

PARA REF. 51219

51385

3,80€

0,07 25 800



4"x1/32"

Ø Interior: 9,53mm  
Ø Exterior: 100mm

## DISCOS LIXA

PARA REF. 51218

51386

5,40€

0,1 25 800



Ø Interior: 22mm  
Ø Exterior: 125mm

5"

PARA REF. 51226

51444

5,00€

0,02 25 800



Ø Exterior: 2"

#80

PARA REF. 51226

51443

5,00€

0,02 25 800



Ø Exterior: 2"

#60

PARA REF. 51226

51445

5,00€

0,02 25 800



Ø Exterior: 2"

#120

## EXPOSITOR DE FERRAMENTA PNEUMÁTICA

53492

379,50€

13 1 7



EXPOSITOR SEM FERRAMENTAS

Ø 50cm



## GANCHO MAGNÉTICO

52378

9,50€

3Kg Ø 6cm



51341

35,00€

9Kg Ø 7cm



52378

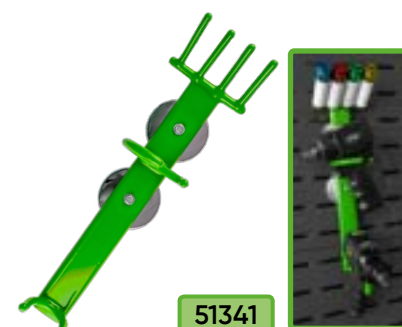

51341

## EXPOSITOR DE FERRAMENTA PNEUMÁTICA

53147

41,00€

EXPOSITOR SEM FERRAMENTAS





## PISTOLA DE ENCHIMENTO

ANALÓGICA

**53449**

19,50€

0,4 5 20 320



0-7 BAR  
0-100 PSI

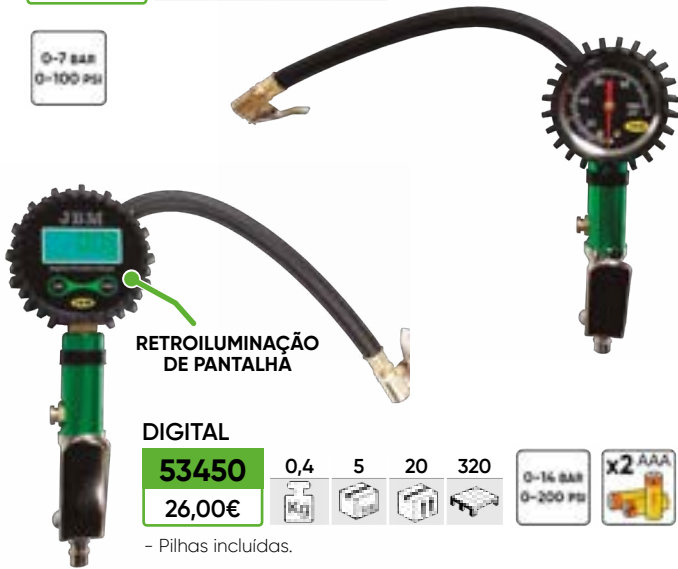

RETROILUMINAÇÃO DE PANTALHA

DIGITAL

**53450**

26,00€

0,4 5 20 320



- Pilhas incluídas.

## PISTOLA LIMPIADORA DE FILTROS DE PARTICULAS

**52543**

157,00€

0,84 6 96



- Universal.
- Base de alumínio + Corpo inox de longa duração.
- Rango de pressão de trabalho: 3 bar - 7 bar (45 psi - 100PSI).
- Capacidade máxima: 650cc.
- Goma de nylon 4x6 x 2,7 m.



LÍQUIDO DESCARBONIZANTE



**90003**

35,20€

1,08 3 12 400

LÍQUIDO NEUTRALIZANTE

**90004**

25,80€

0,5 3 24 320



## PISTOLA DE AR + PISTOLA PARA PNEUMÁTICOS

**51981**

21,50€

0-16 BAR  
0-220 PSI



0,58  
5  
20  
240



## PISTOLA DE AR PARA PNEUMÁTICOS

**51980**

15,00€

0-16 BAR  
0-220 PSI



0,38  
5  
25  
300



## TESTER PRESSÃO DOS PNEUS

**52648**

9,00€

0,1 5 100

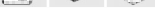

COM TUBO

**53416**

13,50€

0,2 10 100



DIGITAL COM TUBO

**53417**

24,00€

0,3 10 100



DIGITAL

**53418**

15,50€

0,2 10 100 800



5-6 bar



0-10 bar



0-15 BAR  
0-200 PSI



0-15 BAR  
0-300 PSI

0-1.500 KPA



JBM RECOMENDA O USO DE SEUS ÓLEOS LUBRIFICANTES PARA OTIMIZAR O DESEMPENHO E AMPLIAR A VIDA ÚTIL DA FERRAMENTA

EM PAG.144

**14534**  
600ML



**14560**  
100ML



## KIT DE PISTOLAS DE AR

**51277** 1,84 5 40  
64,00€

- Pistola para pintar de pressão com depósito de 600ml.
- Pistola de ar de pneumáticos com manómetro de pressão.
- Pistola de bufar com depósito para limpeza de peças.
- Mangueira em espiral de 5x8mm com conexão rápida 1/4" extensível até 4,5m.
- Pistola de ar.



## PISTOLA DE AR EM BLISTER

**51383** 0,27 10 50 650  
10,50€

- Pistola de ar.
- Conexão rápida europeia.
- Conexão de mangueira.
- Tubo de 10cm.
- Tubo de 20cm.



EM EXPOSITOR DE 10 UDS



## PISTOLA DE AR

**52490** 100mm  
6,50€

**52491** 300mm  
10,50€

0,12 10 40 960

0,1 10 80 400



## PISTOLA DE AR EXTENSÍVEL

**52798** 0,25 10 50 700  
18,00€



PUNTA EMBORRACHADO PARA EVITAR RISCOS



EM EXPOSITOR DE 10 UDS

## PISTOLA PULVERIZADORA LONGA COM BOCAL DE GRANDE CAUDAL

**53611** 0,50 40 160  
27,50€

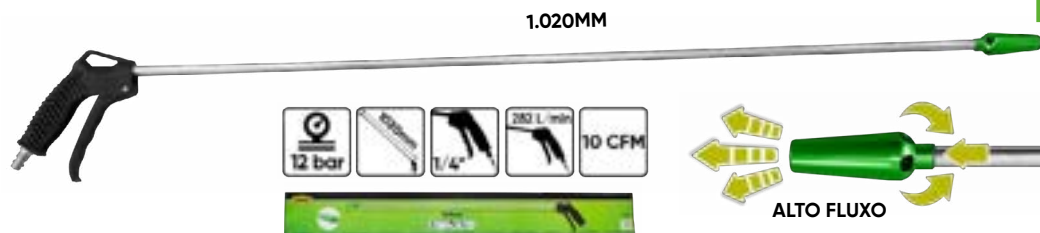

1.020MM



ALTO FLUXO

## FILTRO E REGULADOR DE AR

**53063** 0,63 5 50 1/4"  
29,00€

**53064** 0,63 5 50 3/8"  
29,00€

**53065** 0,63 5 50 1/2"  
30,00€



## FILTRO, REGULADOR DE AR E LUBRIFICADOR

**53066** 1,08 5 25 250 1/4"  
49,50€

**53067** 1,07 5 25 250 3/8"  
48,00€

**53068** 1,06 5 25 250 1/2"  
52,00€



## ACOPLADOR DE ÓLEO 1/4"

**14561** 0,05 25 50 1/4"  
7,50€



## ÓLEO PARA FERRAMENTA PNEUMÁTICA

**14534** 0,55 12 540  
16,50€  
600ml



**14560** 0,10 12 72 1.008  
7,50€  
100ml

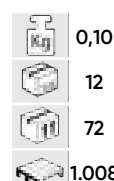

## PISTOLA DE SOPRADO GRANDE CAUDAL

53205

0,9 48 500

19,00€



- Pistola de soprado de grande caudal.
- Material do corpo: Liga de alumínio.
- Superfície: Niquelado.

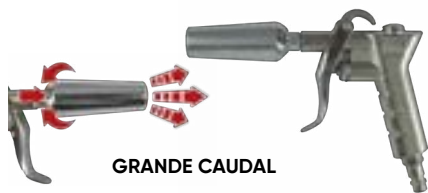

GRANDE CAUDAL

## PISTOLA DE AR EN BLISTER INDIVIDUAL

52787

0,2 25 100 1.000

9,00€



## PISTOLA DE AR DE 3/8" COM MANGUEIRA DE 5m

52381

0,45 5 25 200

20,50€



- Material: PU // 35 torções.



## PISTOLA DE SECAGEM DE AR

53606

0,55 5 20

49,00€



VÁLVULA REGULADORA DE AR

## SUPORTE DE SOPRO DE AR COM 2 PISTOLAS DE SECAGEM

53607

7,35 2 36

276,50€

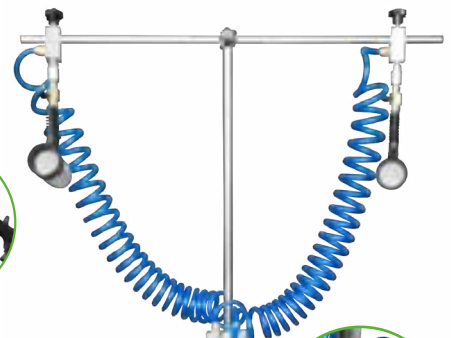

Altura ajustável até 208cm e largura até 86cm.

## PISTOLA DE JACTO DE AREIA PNEUMÁTICA

53593

0,9 5 500

41,00€



- Ideal para a carroçaria e todos os tipos de superfícies metálicas: permite remover a oxidação, a sujidade excessiva e / ou o revestimento, verniz etc. facilmente.

- Inclui:
- 1x pistola jateadora.
- 1x Recolhedor de Areia.
- 2x 850g recipientes de areia.
- Casquilhos 4x:
- para jateamento.
- para jateamento de superfície.
- para jateamento de canto exterior.
- para jateamento de canto interior.



FRASCO DE AREIA PARA REF. 53593

14168

7,00€

1 20



- Tamanho de grão: 46-100MeSH 0.354-0.149mm
- Tamanho de grão: 6-8 bar
- CFM: 6.5
- PSI: 90-120
- Nozzle size: 1/4"

**360°** Permite um movimento de 360° da pistola, além de bloqueá-la em qualquer posição.



- Sustenta com segurança 2 pistolas de secagem
- Inclui 2 manguerias de ar em espiral: 8mm x 12mm x 5m
- Corpo de aço com acopladores de ar de latão

- Contém duas pistolas pneumáticas de secagem (ref. 53606) com as seguintes características: Corpo em alumínio. Pressão de trabalho: 2-4 bar (30-60psi). Consumo de ar: 325 l / min. Entrada de ar: 1/4". Com válvula reguladora de ar.

## PISTOLA DE PETROLEADO

53202

1,4 10 120

15,65€



- Pistola de limpeza do motor.
- Material do pote: Aço.
- Material do corpo: liga de alumínio.
- Superfície: Pintura em pó.



## PISTOLA DE LIMPEZA TORNADO

53204

0,9 5 60

78,00€



- Pistola de limpeza de carros, tornado.
- Material a: PE.
- Material do corpo: Liga de alumínio.
- Superfície do corpo: Pulido.





## CARRETEL DE MANGUEIRA DE AR BOCA DE 3/8" 20+2m

**53582**  
178,50€

10,85 1 14

**53583**  
169,50€

10,85 1 14

20 m + 2 m  
300 PSI  
20 BAR  
3/8"

COM  
REPARTIDOR

SUPORTE DE PA-  
REDE INCLUÍDO



SUPORTE DE  
PAREDE  
0,35 20  
**14772**  
8,50€

## CARRETEL DE MANGUEIRA DE AR BOCA DE 3/8" 12+1m

**53532**  
124,00€

6,7 2 30

**53581**  
107,50€

6,7 2 30

12 m + 1 m  
300 PSI  
20 BAR  
3/8"

SUPORTE DE PA-  
REDE INCLUÍDO

SUPORTE DE PAREDE

0,35 10  
**14771**  
10,50€

## CARRETEL DE MANGUEIRA DE AR BOCA DE 1/4" 10+1,5m

**53881**  
69,00€

4,50 4 48

**53882**  
69,00€

4,50 4 48

10 m + 1,5 m  
150 PSI  
10 BAR  
1/4" PVC

COM  
REPARTIDOR

SUPORTE DE PA-  
REDE INCLUÍDO

# MANGUEIRA ESPIRAL PNEUMÁTICA

**10m** **53629** 8mm / 5mm  
**14,00€**  
 conector 1/4" 0,55 6 390

**15m** **53630** 8mm / 5mm  
**17,50€**  
 conector 1/4" 0,65 6 240

**15m** **53631** 12mm / 8mm  
**31,50€**  
 conector 1/4" 1,40 6 132

**15m** **53632** 15mm / 10mm  
**45,00€**  
 conector 1/4" 2,20 6 78

**15m** **53633** 15mm / 10mm  
**42,50€**  
 conector 3/8" 2,10 6 78

**15m** **53634** 18mm / 13mm  
**57,00€**  
 conector 1/2" 2,60 6 66

COM EXTREMIDADES GIRATÓRIAS DE 360 GRAUS PARA FACILITAR O MOVIMENTO E A FACILIDADE DE USO

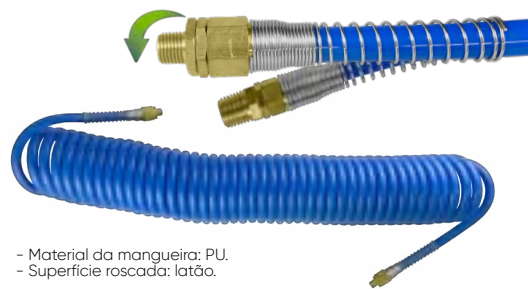

- Material da mangueira: PU.  
 - Superfície rosçada: latão.

**53594** 3,05 4 64  
**54,00€**

**53595** 3,20 4 64  
**61,00€**

**25m** 300 PSI 20 BAR

HYBRID POLYMER



- Pressão de trabalho: 300PSI / 20bar.  
 - Pressão de ruptura: 950PSI / 65bar.  
 - Temperatura de trabalho: -40°C / 65°C

- Grande flexibilidade.  
 - Retorna à sua forma original.  
 - Superfície lisa, não danifica a pintura.  
 - Muito resistente.



**53594**  
 Diâmetro interior: 8mm  
 Diâmetro exterior: 13mm  
 Para usar com:  
 Ref. 52736 M8



**53595**  
 Diâmetro interior: 10mm  
 Diâmetro exterior: 15mm  
 Para usar com:  
 Ref. 52737 M10



x10 JOGO DE 10 BRAÇADEIRAS 8-16mm

0,04 10 100 **14169**  
**3,00€**

## CONECTOR RÁPIDO COM O FIXADOR PROTECTOR FÊMEO - CONEXÃO DE MANGUEIRA

**14201**  
**4,00€**

**14202**  
**4,00€**

**14203**  
**4,50€**

**14314** EUR 1/4"  
**5,00€**

**14315** US 1/4"  
**4,50€**

0,1 25 100

0,1 25 100

0,1 25 100

0,1 25 100

0,1 25 100



## CONECTOR DE MANGUEIRA

REF.	DESCRIÇÃO	Qtd	€
14204	EUR - M6	0,10	1,50€
14205	EUR - M8	0,10	1,50€
14206	EUR - M10	0,10	1,50€
14207	US - M6	0,10	1,50€
14208	US - M8	0,10	1,50€
14209	US - M10	0,10	1,50€

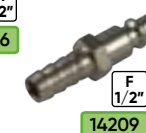

50 200

## CONECTOR RÁPIDO COM O FIXADOR PROTETOR FÊMEO

REF.	DESCRIÇÃO	Qtd	€
14195	ROSCA INTERNA - ROSCA EXTERNA 1/4"	0,10	4,00€
14196	ROSCA INTERNA - ROSCA EXTERNA 3/8"	0,10	4,00€
14197	ROSCA INTERNA - ROSCA EXTERNA 1/2"	0,10	4,50€
14198	ROSCA INTERNA - ROSCA INTERNA 1/4"	0,10	4,00€
14199	ROSCA INTERNA - ROSCA INTERNA 3/8"	0,10	4,00€
14200	ROSCA INTERNA - ROSCA INTERNA 1/2"	0,10	4,50€



25 100

EUR.



UNIVERSAL



US

## CONECTOR / ROSCA

REF.	DESCRIÇÃO	€
<b>US</b>		
13930	CONECTOR MACHO - ROSCA MACHO DE 1/4"	0,05 1,50€
13932	CONECTOR MACHO - ROSCA MACHO 3/8"	0,1 2,50€
14076	CONECTOR MACHO - ROSCA FÊMEA DE 3/8"	0,1 1,50€
13933	CONECTOR MACHO - ROSCA MACHO DE 1/2"	0,1 2,00€
13935	CONECTOR MACHO - ROSCA FÊMEA DE 1/4"	0,05 2,50€
13936	CONECTOR FÊMEA - ROSCA FÊMEA DE 1/4"	0,05 3,50€
13937	CONECTOR FÊMEA - ROSCA MACHO DE 1/4"	0,05 4,00€
14078	CONECTOR FÊMEA - ROSCA FÊMEA DE 3/8"	0,1 4,00€
14191	CONECTOR MACHO - ROSCA FÊMEA DE 1/2"	0,1 2,00€
14193	CONECTOR FÊMEA - ROSCA FÊMEA DE 1/2"	0,1 4,00€
<b>EUR.</b>		
13931	CONECTOR MACHO - ROSCA MACHO DE 1/4"	0,05 2,50€
14075	CONECTOR MACHO - ROSCA FÊMEA DE 3/8"	0,1 2,00€
13934	CONECTOR MACHO - ROSCA FÊMEA DE 1/4"	0,05 2,50€
13938	CONECTOR FÊMEA - ROSCA FÊMEA DE 1/4"	0,1 3,50€
13939	CONECTOR FÊMEA - ROSCA MACHO DE 1/4"	0,1 4,00€
14077	CONECTOR FÊMEA - ROSCA FÊMEA DE 3/8"	0,1 4,50€
14190	CONECTOR MACHO - ROSCA FÊMEA DE 1/2"	0,1 2,00€
14192	CONECTOR FÊMEA - ROSCA FÊMEA DE 1/2"	0,1 4,00€

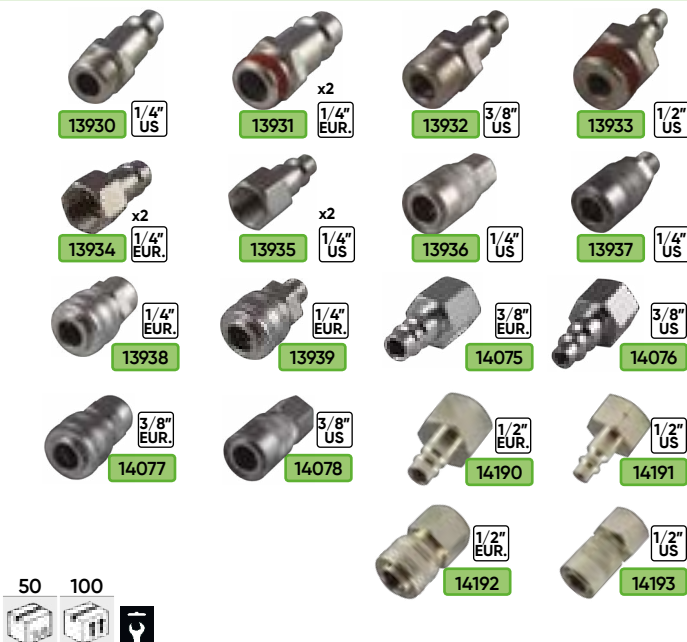

## ENGATE RÁPIDO PNEUMÁTICO

**52735** 0,07 25 200 **M6**  
4,50€

**52736** 0,07 25 200 **M8**  
4,50€

**52737** 0,08 25 200 **M10**  
5,00€



- Contém uma tomada externa e interna.

## ADAPTADOR ARTICULADO PNEUMÁTICO

**12988** 0,15 125 **1/2"**  
12,00€

**13809** 0,10 250 **1/4"**  
18,50€

**13810** 0,10 250 **3/8"**  
20,50€





KIT DE CHAVES



150

CONJUNTO DE SOQUETE



151

CABOS DE EXTENSÃO / ARTICULAÇÕES DE IMPACTO



152

CONJUNTO DE PUNTAS



153

ADAPTADORES DE IMPACTO / CHAVES DE IMPACTO DE 3/4" E 1"



154

CHAVES DE IMPACTO



155

CHAVES PARA VEÍCULOS PESADOS



156



# FERRAMENTAS DE IMPACTO



## KIT DE 6 CHAVES DE IMPACTO DE 1/2" HEX

**52337** 1,91 5 10 300  
51,00€

1/2" 6 PCS

CONTÉM

x3 80mmL 30, 32, 36mm  
x3 43mmL 14, 17, 19mm



## SET DE 8 CHAVES E PUNTAS XZN DE IMPACTO DE 1/2"

**52547** 2,76 5 200  
76,00€

1/2" 8 PCS

CONTÉM

x4 27, 30, 32, 34, 36mm  
x3 43mmL M14, M16, M18



## KIT DE 13 CHAVES DE IMPACTO DE 1/2" HEX + ADAPTADOR

**52341** 1,72 12 336  
47,50€

1/2" 13 PCS

10, 11, 12, 13, 14, 17, 19, 21, 22, 24mm

DESMANCHA DISPONÍVEL

REF.	mm	kg	pcs	€	REF.	mm	kg	pcs	€
14728	10mm	0,10	5 20	3,00€	11195	17mm	0,10	10 50	3,50€
14729	11mm	0,05	5 20	3,50€	11121	19mm	0,10	10 60	3,50€
14730	12mm	0,05	5 20	3,50€	14733	21mm	0,10	5 20	4,00€
14731	13mm	0,10	5 20	3,00€	14734	22mm	0,15	5 20	4,50€
14732	14mm	0,10	5 20	3,50€	11122	24mm	0,15	10 20	4,50€
14735	Suporte de juntas de imp.		0,05 5 20	6,50€	12074	Aumento de imp. 250mm		0,23 10 60	11,50€
11990	Artic. universal de impacto		0,15 10 100	14,00€					



## SET DE 3 CHAVES XZN DE 1/2" DE IMPACTO

**52694** 1,31 5 10 600  
38,00€

1/2" 3 PCS

30, 32, 36mm (78mmL)



## KIT 19 CHAVES DE IMPACTO DE 1/2" + ADAPTADOR

**52345** 3,55 6 234  
87,50€

**53531** 3,55 4 234  
87,50€

1/2" 19 PCS

52345: DESMANCHA DISPONÍVEL

REF.	mm	kg	pcs	€	REF.	mm	kg	pcs	€
14728	10mm	0,10	5 20	3,00€	14733	21mm	0,10	5 20	4,00€
14729	11mm	0,05	5 20	3,50€	14734	22mm	0,15	5 20	4,50€
14730	12mm	0,05	5 20	3,50€	11122	24mm	0,15	10 20	4,50€
14731	13mm	0,10	5 20	3,00€	11123	27mm	0,35	10 50	5,50€
14732	14mm	0,10	5 20	3,50€	12937	Aumento de impacto 50mm		0,11 10 100	9,50€
14970	15mm	0,08	5 20	2,50€	14973	Aumento de impacto 150mm		- 5 20	11,50€
14971	16mm	0,07	5 20	2,50€	12075	Aumento de impacto 250mm		0,45 10 50	15,50€
11195	17mm	0,10	10 50	3,50€	11962	Adaptador de impacto 1/2"H 3/4"M		0,15 10 100	7,50€
14972	18mm	0,12	5 20	3,50€	11990	Artic. universal de impacto		0,15 10 100	14,00€
11121	19mm	0,10	10 60	3,50€					



## KIT 12 CHAVES DE IMPACTO COMPRIDOS DE 1/2"

**52346** 4,55 6 216  
87,00€

1/2" 15 PCS

DESMANCHA DISPONÍVEL

REF.	mm	kg	pcs	€	REF.	mm	kg	pcs	€
12071	24mm	0,30	10 50	11,00€	12061	10mm	0,14	10 100	9,50€
12072	27mm	0,35	10 20	12,00€	12062	12mm	0,15	10 100	9,50€
12074	Aumento de impacto 125mm		0,23 10 60	11,50€	12063	13mm	0,15	10 50	9,50€
12075	Aumento de impacto 250mm		0,45 10 50	15,50€	12064	15mm	0,17	10 100	9,00€
11990	Artic. universal de impacto		0,15 10 100	14,00€	12065	16mm	0,30	10 20	9,00€
					12066	17mm	0,20	10 50	9,00€
					12067	18mm	0,20	10 20	9,50€
					12068	19mm	0,21	10 50	9,50€
					12069	21mm	0,25	10 50	9,50€
					12070	22mm	0,30	10 20	10,50€



## JOGO DE 12 CHAVES DE IMPACTO 1/2" HEX.PERFIL BAIXO

**53060**  
31,00€

0,86 5 25 500

10, 11, 12, 13, 14, 15, 16, 17, 18, 19, 20, 21mm (28,2mmL)



1/2"

12 PCS

28mmL



## KIT DE 11 CHAVES DE IMPACTO DE 1/2"

**53744**  
51,00€

2,30 5 10



**52342**  
53,00€

2,41 5 10 360



1/2"

11 PCS

10, 11, 12, 13, 14, 16, 17, 19, 21, 22, 24mm (78mmL)



### DESMANCHA DISPONÍVEL

REF.	mm				€
12061	10mm	0,14	10	100	9,50€
14736	11mm	0,15	5	20	5,00€
12062	12mm	0,15	10	100	9,50€
12063	13mm	0,15	10	50	9,50€
14737	14mm	0,15	5	20	5,00€
12065	16mm	0,30	10	20	9,00€
12066	17mm	0,20	10	50	9,00€
12068	19mm	0,21	10	50	9,50€
12069	21mm	0,25	10	50	9,50€

**52342**



REF.	mm				€
12070	22mm	0,30	10	20	10,50€
12071	24mm	0,30	10	50	11,00€

## KIT DE 3 CHAVES DE IMPACTO HEX. LONGO

**52969**  
17,00€

0,8 20 1.500

17, 19, 21mm (78mmL)



1/2"

3 PCS



DESMANCHA DISPONÍVEL

REF.	mm				€
12066	17mm	0,18	10	50	9,00€
12068	19mm	0,21	10	50	9,50€
12069	21mm	0,20	10	50	9,50€

## CONJUNTO DE SOQUETE DE IMPACTO PARA RODAS DE 4 PEÇAS DE LIGA LEVE - 1/2" DR.

**53587**  
36,00€

1,05 5 20

1/2"

4 PCS

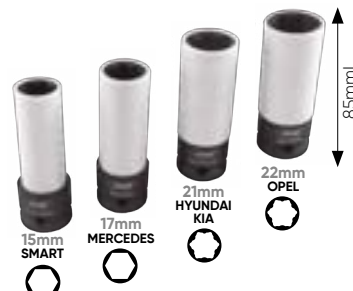

85mmL



### DESMANCHA DISPONÍVEL

REF.	mm				€
14172	15mm - SMART	0,20	10	50	8,50€
14173	17mm - MERCEDES	0,20	10	50	9,50€
14177	22mm - OPEL	0,25	10	50	9,50€
14178	21mm - HYUNDAI/KIA	0,25	10	50	9,50€



## KIT 4 CHAVES IMPACTO DE 1/2" PARA RODAS

**52338**  
32,50€

1,12 5 20 640



1/2"

4 PCS

17, 19, 21, 22mm (85mmL)



DESMANCHA DISPONÍVEL

REF.	mm				€
11314	17mm	0,21	10	100	8,50€
11315	19mm	0,23	10	100	8,50€
11316	21mm	0,26	10	100	8,50€
11628	22mm	0,27	10	50	9,50€



## KIT DE 3 CHAVES DE IMPACTO DE 1/2"

**51336**  
21,05€

0,82 5 725

17, 19, 21mm (85mmL)



1/2"

3 PCS





## KIT DE 10 CHAVES DE IMPACTO DE 1/2"

**53988**  
90,00€

1,5 5  
85mm

1/2" 10 PCS



### CONTÉM

x7 1/2"	15, 17, 19, 21, 22, 23, 24mm
x1 7/8"	Tesla
x1 17mm	Mercedes
x1 21mm	Hyundai/Kia

## KIT DE 12 CHAVES DE IMPACTO DE 1/2" HEX.

**52343**  
43,00€

1,89 4 360

1/2" 12 PCS



### CONTÉM

x3 85mmL	17, 19, 21mm
x1 42mmL	27mm
x8 38mmL	10, 11, 13, 14, 17, 19, 22, 24mm

## CONJUNTO DE 4 CHAVES DE IMPACTO PARA PARAFUSOS DE SEGURIDADE

**53197**  
40,50€

1,17 5 20

1/2" 4 PCS

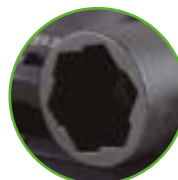

17, 19, 21, 22mm (82mmL)

## CONJUNTO DE CABOS DE EXTENSÃO COM LIMITAÇÃO DE TORQUE

**53077**  
61,00€

1,58 10 240

CrMo 1/2" 5 PCS



100, 110, 120, 135, 150 Nm

## BARRAS DE EXTENSÃO DE IMPACTO

200NM <b>13680</b> 0,36 15,50€	175NM <b>13682</b> 0,32 15,50€	150NM <b>13684</b> 0,28 15,50€	120NM <b>13686</b> 0,23 15,50€	100NM <b>13688</b> 0,22 15,50€
190NM <b>13681</b> 0,35 15,50€	160NM <b>13683</b> 0,3 15,50€	135NM <b>13685</b> 0,26 15,50€	110NM <b>13687</b> 0,22 15,50€	90NM <b>13689</b> 0,2 5 50 15,25€

## AUMENTO DE IMPACTO

**12937**  
9,50€

0,11 10 100 1.500

**12074**  
11,50€

0,23 10 60

**12075**  
15,50€

0,43 10 50

1/2"

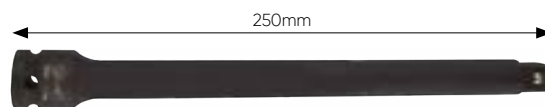
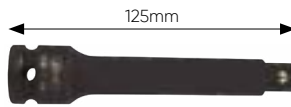
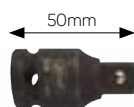

## ARTICULAÇÃO UNIVERSAL DE IMPACTO 3/4" - 1/2"

**11938**  
39,00€

0,6 60 3/4"



11938

**11990**  
14,00€

0,16 100 1/2"



11990

## KIT DE 3 ARTICULAÇÕES DE IMPACTO COM DUPLA POSIÇÃO (FIXO/ARTICULADO)

**53043**  
38,50€

0,43 5 50 1.000

1/2" 3/8" 1/4"

3 PCS



## KIT DE 8 CHAVES DE IMPACTO HEX. COM DUPLA POSIÇÃO (FIXO/ARTICULADO)

53044

116,00€

2,43

8

1.000



1/2"

8  
PCS

13, 14, 15, 16, 17,  
19, 21, 22mm

## SET DE 6 CHAVES E PUNTAS XZN DE IMPACTO DE 1/2"

52546

31,50€

0,81

30

720



1/2"

6  
PCS



### CONTÉM

x3 M14, M16, M18  
43mmL

x3 M14, M16, M18  
78mmL

## CHAVE PONTA XZN INVIOLEVEL

52810

9,20€

0,17

100

M16



1/2"

75mm



- Soquetes de impacto de 75mm de comprimento quadrados de 1/2" para extrair o parafuso de drenagem com chave de impacto em transmissões de VAG, Porsche, Ford, etc.

52811

9,20€

0,17

5

100

M18



- Para extrair o braço de direção do veículo do grupo VAG.



## KIT 13 CHAVES DE IMPACTO DE 1/2" HEX E TORX

52344

158,00€

1,89

4

288



1/2"

13  
PCS

### CONTÉM

x5 5, 6, 8, 10, 12mm  
45mmL

x8 T30, T40, T45, T50,  
T55, T60, T70, T80  
45mmL

## KIT DE 8 CHAVES DE IMPACTO HEX DE 1/2"

52339

58,00€

1,27

5

10

480



### DESMANCHA DISPONÍVEL



REF.	mm	0,1	0,2	10	240	€
14004	5mm	0,1	10	240	9,50€	
14005	6mm	0,1	10	60	10,50€	
14006	7mm	0,1	10	240	9,50€	
14007	8mm	0,2	10	240	9,50€	
14008	10mm	0,1	10	240	9,50€	
14009	12mm	0,1	10	240	9,50€	
14010	14mm	0,1	10	60	11,00€	
14011	17mm	0,2	10	60	11,00€	



1/2"

8  
PCS

5, 6, 7, 8, 10, 12, 14,  
17mm (78mmL)

## KIT DE 8 CHAVES DE IMPACTO TORX DE 1/2"

52340

58,00€

1,16

5

10

300



### DESMANCHA DISPONÍVEL



REF.	mm	0,08	0,1	10	50	€
12938	T25	0,08	10	50	10,00€	
12939	T30	0,09	10	50	10,00€	
12940	T40	0,09	10	50	10,00€	
12941	T45	0,09	10	50	10,00€	
12942	T50	0,09	10	60	10,00€	
12943	T55	0,1	10	50	10,00€	
12944	T60	0,12	10	50	10,00€	
12945	T70	0,14	10	20	10,50€	



1/2"

8  
PCS

T25, T30, T40, T45, T50,  
T55, T60, T70 (78mmL)

## CONJUNTO DE 6 CABEÇAS DE CHOQUE

**53743**  
34,00€

0,80 5 20

**6**  
PCS



M	F
3/4"	1/2"
1/2"	3/4"
3/8"	1/4"
1/4"	3/8"
1/2"	3/8"
3/8"	1/2"



### DESMANCHA DISPONÍVEL

REF.	mm				€
14749	1/4" F - 3/8" M	-	20	100	2,00€
14750	3/8" M - 1/4" F	-	20	100	2,00€
14751	3/8" M - 1/2" F	-	20	100	4,00€
14752	1/2" F - 3/8" M	-	10	100	4,00€

## JOGO DE 2 ADAPTADORES DE IMPACTO 1"-1/2"

**52545**  
138,00€

1,97 4

1" 1/2" F - 1" M  
1" F - 1" 1/2" M



## JOGO DE 8 CHAVES DE IMPACTO LARGAS HEX. DE 3/4"

**53470**  
146,50€

7,5 1 85

**3/4"** **8**  
PCS

24, 27, 29, 30, 32, 34, 36, 38mm (90mmL)



## SET DE 16 CHAVES DE IMPACTO

**51028**  
158,00€

6,26 2 380

**3/4"** **16**  
PCS

### CONTÉM

	<b>3/4"</b>	x4	E18, E20, E22, E24
	<b>3/4"</b>	x5	T60, T70, T80, T90, T100
	<b>3/4"</b>	x4	H17, H19, H22, H24
	<b>1" - 3/4"</b>	x2	
		x1	4mm



### DESMANCHA DISPONÍVEL

REF.	mm				€
14723	H17	0,35	-	10	18,00€
14724	T60	0,30	-	10	18,50€
14725	T70	0,30	-	10	18,50€
14726	T80	0,30	-	10	17,50€



## SET DE 6 ADAPTADORES DE IMPACTO

**52544**  
78,00€

2,89 4 420

**6** **1"** **3/4"** **1/2"**  
PCS

### CONTÉM

1/2" x2	F x 1" M (50mmL), F x 3/4" M (48mmL)
3/4" x2	F x 1" M (63mmL), F x 1/2" M (85mmL)
1" x2	F x 3/4" M (69mmL), F x 1/2" M (70mmL)



### DESMANCHA DISPONÍVEL

REF.	mm				€
11962	1/2" H - 3/4" M	0,16	10	100	7,50€
11963	1/2" H - 1" M	0,26	6	54	9,00€
11964	3/4" H - 1/2" M	0,34	6	36	12,50€
11965	3/4" H - 1" M	0,44	6	48	16,00€
11966	1" H - 1/2" M	0,53	6	36	18,00€
11967	1" H - 3/4" M	0,53	4	36	18,00€



## KIT DE 8 CHAVES DE IMPACTO DE 3/4"

**52347**  
130,50€

6,53 4 200

**3/4"** **8**  
PCS

26, 27, 29, 30, 32, 35, 36, 38mm (90mmL)



## KIT DE 8 CHAVES DE IMPACTO DE 1"

**52348**  
154,00€

6,08 2 252

**1"** **8**  
PCS

24, 27, 30, 32, 33, 36, 38, 41mm



### DESMANCHA DISPONÍVEL

REF.	mm				€
13859	24mm	0,6	6	96	16,00€
13874	27mm	0,6	6	24	17,50€
13875	30mm	0,5	6	18	18,50€
13876	32mm	0,6	6	24	18,50€
13877	33mm	0,6	6	24	18,50€
11153	36mm	0,7	6	18	19,00€
11155	38mm	0,9	6	12	20,00€
11158	41mm	0,95	6	18	23,50€





# CHAVES DE IMPACTO



REF.	mm				€
11153	36mm	0,71	6	18	19,00€
11154	37mm	0,73	6	24	19,50€
11155	38mm	0,74	6	12	20,00€
11156	39mm	0,74	6	24	21,50€
11157	40mm	0,78	6	12	24,00€
11158	41mm	0,81	6	18	23,50€
11159	42mm	0,91	6	18	25,00€
11160	43mm	0,94	6	12	24,50€
11161	44mm	0,93	6	18	26,00€
11162	45mm	0,94	4	8	26,50€
11163	46mm	1,00	4	12	27,00€
11164	47mm	1,02	4	8	27,50€
11165	48mm	1,01	4	8	28,00€
11166	50mm	1,18	4	12	28,00€
11167	51mm	1,18	4	8	34,00€
11168	52mm	1,18	1	10	33,50€
11169	53mm	1,27	4	12	35,50€
11170	54mm	1,33	4	12	36,00€
11171	55mm	1,44	2	8	40,00€
11172	56mm	1,47	4	8	43,00€
11173	57mm	1,44	4	8	42,00€
11174	58mm	1,58	4	8	42,00€
11175	59mm	1,58	4	8	43,50€
11176	60mm	1,62	2	4	44,50€
11177	62mm	1,63	2	4	49,00€
11178	63mm	1,75	-	8	47,50€
11179	65mm	1,87	2	8	51,50€
11180	67mm	1,93	2	8	52,50€
11181	68mm	1,93	2	8	58,00€
11182	70mm	2,09	2	4	59,00€
11183	71mm	3,10	-	6	63,50€
11184	73mm	3,27	1	4	77,50€
11185	75mm	3,34	1	6	79,00€
11186	76mm	3,70	1	5	80,50€
11187	78mm	3,47	1	5	87,50€
11188	80mm	3,69	1	4	91,00€
11189	85mm	3,81	1	4	98,50€
11190	89mm	3,80	1	2	122,00€
11191	90mm	4,29	1	4	117,50€
11192	92mm	4,50	1	2	133,50€
11193	95mm	4,89	1	2	147,00€
11194	100mm	4,36	1	4	155,00€
11621	105mm	7,81	-	2	273,00€
11622	110mm	7,75	-	2	341,60€
11623	115mm	8,21	-	3	380,00€

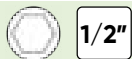

REF.	mm				€
14728	10mm	0,10	5	20	3,00€
14729	11mm	0,05	5	20	3,50€
14730	12mm	0,05	5	20	3,50€
14731	13mm	0,10	5	20	3,00€
14732	14mm	0,10	5	20	3,50€
11195	17mm	0,10	10	50	3,50€
11121	19mm	0,10	10	60	3,50€
14733	21mm	0,10	5	20	4,00€
14734	22mm	0,15	5	20	4,50€
11122	24mm	0,14	10	20	4,50€
11123	27mm	0,17	10	50	5,50€
11124	30mm	0,20	10	50	6,50€
11125	32mm	0,22	10	50	7,00€



REF.	mm				€
11126	19mm	0,25	6	60	10,00€
11127	21mm	0,29	6	24	11,50€
11128	22mm	0,34	6	24	11,50€
11129	24mm	0,32	6	54	11,50€
11130	25mm	0,33	6	24	12,00€
11131	26mm	0,32	6	36	11,50€
11132	27mm	0,35	6	54	11,00€
11133	28mm	0,40	6	48	11,00€
11134	30mm	0,41	6	54	12,00€
11135	32mm	0,44	6	48	14,00€
11136	33mm	0,47	6	24	14,00€
11137	34mm	0,51	6	24	14,50€
11138	35mm	0,49	6	12	15,00€
11139	36mm	0,52	6	18	15,50€
11140	38mm	0,53	6	24	16,50€
11141	40mm	0,54	6	12	17,00€
11142	41mm	0,61	6	12	17,00€
11143	46mm	0,74	6	18	21,50€
11144	50mm	1,00	6	24	27,00€
11145	51mm	1,10	4	12	29,00€
11146	55mm	1,23	4	12	30,50€
11147	57mm	1,23	4	12	36,00€
11148	60mm	1,40	4	12	38,00€
11149	63mm	1,32	4	12	40,50€
11150	65mm	1,50	-	8	44,00€
11151	67mm	1,49	4	12	50,50€
11152	70mm	1,49	4	12	56,50€



REF.	mm				€
11624	65mm	2,42	1	2	151,00€
11625	85mm	5,11	1	2	242,50€
12984	105mm	4,8	-	2	288,50€

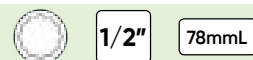

REF.	mm				€
14738	10mm	-	10	100	5,00€
14739	11mm	-	10	100	5,00€
14740	12mm	-	10	100	5,00€
14741	13mm	-	10	100	5,00€
14742	14mm	-	10	100	5,00€
14743	16mm	-	10	100	5,00€
14744	17mm	-	10	50	5,00€
14745	19mm	-	10	50	5,50€
14746	21mm	-	10	50	6,00€
14747	22mm	-	10	50	6,50€
14748	24mm	-	10	50	7,00€
11613	27mm	0,34	10	20	10,00€
11614	30mm	0,42	10	40	12,00€
11615	32mm	0,38	6	24	12,50€
11616	33mm	0,45	6	12	15,50€
11617	34mm	0,40	6	24	16,50€
11618	35mm	0,46	6	18	16,50€
11619	36mm	0,47	6	36	17,00€



REF.	mm				€
12061	10mm	0,14	10	100	9,50€
14736	11mm	0,15	5	20	5,00€
12062	12mm	0,15	10	100	9,50€
12063	13mm	0,13	10	50	9,50€
14737	14mm	0,15	5	20	5,00€
12064	15mm	0,17	10	100	9,00€
12065	16mm	0,16	10	20	9,00€
12066	17mm	0,18	10	50	9,00€
12067	18mm	0,23	10	20	9,50€
12068	19mm	0,21	10	50	9,50€
12069	21mm	0,24	10	50	9,50€
12070	22mm	0,28	10	50	10,50€
12071	24mm	0,30	10	50	11,00€
12072	27mm	0,35	10	20	12,00€



REF.	mm				€
13723	19mm	0,41	6	54	15,00€
13724	21mm	0,48	6	12	15,00€
13725	22mm	0,61	6	18	15,00€
13726	24mm	0,56	6	24	15,50€
13727	26mm	0,51	6	18	14,50€
13728	27mm	0,50	6	18	14,50€
13729	29mm	0,71	6	24	17,50€
13730	30mm	0,68	6	24	17,50€
13731	32mm	0,71	6	24	17,50€
13732	33mm	0,78	5	15	18,50€
13733	34mm	0,81	6	18	19,50€
13734	35mm	0,80	6	18	20,00€
13735	36mm	0,81	6	12	20,50€
13736	38mm	0,83	-	6	20,00€



REF.	mm				€
13745	28mm	0,77	6	24	19,50€
13746	30mm	0,95	6	12	19,50€
13747	32mm	0,90	6	12	19,50€
13748	33mm	0,89	6	12	19,00€



# CHAVES PARA VEÍCULOS PESADOS

## SOQUETE COBERTURAS CAMINHÃO BPW

**52914** 3,16 1 4  
**199,00€**

- Extração casquilho eixo traseiro BPW.

120mm 8 CANTOS  
 CUADRADO HEXAGONAL 41mm



## SOQUETE NUT RODA CAMINHÃO BPW

**52915** 2,94 1 8 1.500  
**179,00€**

- Extração casquilho eixo traseiro BPW.

111mm OVAL  
 CUADRADO HEXAGONAL 41mm



## SOQUETE NUT RODA CAMINHÃO BPW

**52916** 2,57 1 8 1.000  
**169,00€**

- Extração casquilho eixo traseiro BPW.

109mm 8 CANTOS  
 CUADRADO HEXAGONAL 41mm



## SOQUETE EIXO TRASEIRO CAMINHÃO BPW

**52917** 1,11 1  
**118,00€**

- Extração casquilhos tractores 6,5-9 TON.

65mm OVAL  
 CUADRADO HEXAGONAL 36mm



## SOQUETE HUBCAPS EIXO TRASEIRO BPW

**52918** 2,05 1 8 1.500  
**135,00€**

- Extração eixo traseiro.

95mm  
 CUADRADO 3/4"



## SOQUETE NUT RODA BPW

**52919** 2,8 1 8 1.500  
**165,00€**

- Extração eixo traseiro.

110mm 8 CANTOS  
 CUADRADO 3/4"



## SOQUETE EXTRAÇÃO RO- LAMENTOS EIXO BPW

**52920** 1,35 1 10 1.000  
**132,50€**

- Para remover os rolamentos acima nut em eixos BPW 12 TON.

80mm  
 CUADRADO 3/4"



## SOQUETE EXTRAÇÃO NUT EIXO TRASEIRO BPW

**52921** 0,73 1 12  
**99,00€**

- Para remover os rolamentos acima nut em eixos BPW 6,5-9 TON.

65mm  
 CUADRADO 3/4"



## SOQUETE EXTRAÇÃO NUT ROLAMENTOS EIXOS BPW

**52922** 2,24 1 10 1.000  
**134,00€**

- En eixos BPW 16 TON.

85mm 6 CANTOS  
 CUADRADO 3/4"



## SOQUETE EXTRAÇÃO NUT SUSPENSÃO SCANIA

**52923** 0,45 1 12 1.500  
**47,50€**

28x37mm  
 CUADRADO 3/4"



## SOQUETE EXTRAÇÃO EIXO SUSPENSÃO SCANIA

**52924** 0,65 1 24 1.500

58,00€



34x46mm

CUADRADO 3/4"



## SOQUETE RODA DIANTEIRA SCANIA

**52925** 1,95 1 8 1.500 - Extração nut eixos dianteiros.

142,50€



80mm

8 CANTOS

CUADRADO HEXAGONAL 41mm



## SOQUETE EXTRAÇÃO RODA NUT SCANIA

**52926** 2,93 1 8 1.500 - Extração nut eixos traseiros.

159,50€



100mm

8 CANTOS

CUADRADO 3/4"



## SOQUETE EXTRAÇÃO NUT BALLESTA SCANIA

**52927** 0,78 1 20 1.000

65,00€



34x56mm

CUADRADO 3/4"



## SOQUETE HUB SCANIA

**52928** 2,01 1 10 1.500 - Extração nut eixo dianteiro.

139,00€



80mm

8 CANTOS

CUADRADO 3/4"



## SOQUETE NUT RODA SCANIA

**52929** 2,68 1 8 1.500 - Extração nut hub terceiro eixo de caminhão eixos 10.

145,00€



95mm

8 CANTOS

CUADRADO 3/4"



## INSTALADOR PARA VIRABREQUIM TRASEIRO RETENTOR ÓLEO SCANIA

**52930** 2,86 1 4 1.500

115,00€



SCANIA 310/320

RETENTOR 0366303-R



## SOQUETE CAMINHÃO SCANIA ROTAÇÃO EIXO DE COMANDO

**52931** 0,23 1 60

45,00€



CUADRADO 1/2"



## SOQUETE PARA VALVULA DE INJEÇÃO ELECTRO-MAGNETICA SCANIA

**52932** 0,47 1 20 1.500

44,00€



Ø 38mm

CUADRADO 1/2"



## SOQUETE HUB SCANIA

**52933** 3,15 1 5

165,50€



SCANIA 420

8 ALMENAS

CUADRADO 3/4"

Ø Exterior: 11,6cm  
Ø Interior: 10cm





# CHAVES PARA VEÍCULOS PESADOS

## CHAVE DE BUCHA PARA IVECO

**53430** 2,90 1 8  
239,50€

- Utilizado com uma tomada ou chave de 36mm.

Ø Exterior: 134mm  
Ø Interior: 110,5mm

IVECO

12 FACES

118x134mm



## SOQUETE HUB PARAFUSOS CAMINHÃO BENZ / MAN

**52935** 0,97 1 10 1.000  
85,00€

60mm

CUADRADO 3/4"



## SOQUETE EXTRAÇÃO HUB CAMINHÃO BENZ/MAN

**52936** 1,58 1 10 1.500  
158,00€

- Útil em vans.

80-95mm

6 ALMENAS

CUADRADO 3/4"



## SOQUETE EXTRAÇÃO HUB TRASEIRO CAMIÓN BENZ/MAN

**52937** 3,05 1 6 1.500  
215,00€

- Extração hub eixo dianteiro.

95-115mm

6 ALMENAS

CUADRADO 3/4"



## SOQUETE EXTRAÇÃO NUT ENDEREÇO DO CAMINHÃO BENZ / MAN

**52938** 3,22 1 6 1.500  
157,50€

- Extração de nut del eixo de endereço.

100mm

6 ALMENAS

CUADRADO 3/4"



## SOQUETE EXTRAÇÃO VALVULA INJECCÃO MAN / BENZ / SCANIA

**52939** 0,18 1 30 1.500  
28,00€

22-28mm

4 ALMENAS

CUADRADO 3/4"

DIESEL



## SOQUETE CAMINHÃO BENZ / MAN PARA NUT DIFERENCIAL TRASEIRO

**52940** 4,34 1 4 1.500  
200,00€

104mm

6 ALMENAS

CUADRADO 3/4"



## ÚTIL ROTAÇÃO VOLANTE BENZ E MAN 2 GEARS

**52941** 0,54 1 20 1.500  
61,00€

- Para Benz de 6, 8 e 10 cilindros.  
- Para MAN de 12 cilindros.

CUADRADO 1/2"



## ÚTIL ROTAÇÃO VOLANTE BENZ Y MAN 3 GEARS

**52942** 0,87 1 20  
84,50€

- Para Mercedes Actros e Atego.  
- Para MAN de 5,6 e 8 cilindros.

CUADRADO 1/2"



## UTIL CAMINHÃO ROTAÇÃO VOLANTE DE MOTOR MAN

**52943** 0,49 1 30 1.500  
69,00€

CUADRADO 1/2"



## EXTRACTOR DE CABEÇA DE CAMINHÃO E VEÍCULOS COMERCIAIS

**52944** 0,94 1 20 1.500  
89,00€

30mm

CUADRADO HEXAGONAL 19mm



## EXTRACTOR DE CABEÇA DE CAMINHÃO E VEÍCULOS COMERCIAIS

**52945** 2,74 8  
220,50€

39mm

CUADRADO HEXAGONAL 26mm



## SOQUETE HUB PARAFUSOS CAMINHÃO BENZ/ MAN

**52934** 1,05 1  
88,00€

56mm

CUADRADO 3/4"



KITS PARA CHAPEIROS



RESTAURAÇÃO DE FARÓIS / CAPACETE PARA SOLDAGEM



JOGO PALANCAS



JOGO DE UTENSÍLIOS PARA ABRIR CARROS / FERRAMENTAS PARA SUBSTITUIÇÃO DE LUAS / ALICATE PRESSÃO



PISTOLAS SILICONE / VENTOSAS / CINTA DE APRETO

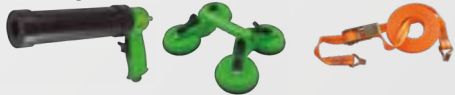

CARRO PARA ARMAZENAGEM DE PEÇAS / CAVALETES



SUPORTES



MANUTENÇÃO DE VEÍCULOS



EXPOSITORES



TAPETES



PLATAFORMA DE ALUMÍNIO



160

161

162

163

167

168

169

171

172

173

174



# CARROÇARIA



## KIT REPARADOR DE AMOLGADELAS

53224

141,50€

3,9

5

40

32  
PCS

- 1 pistola de cola (220-240V ~, 50Hz, 40W).
- 1 martelo deslizante para a extracção de amolgadelas profundas.
- 1 levantador de amolgadelas para a extracção de amolgadelas ligeiras em superfícies planas.
- 1 limpador de cola.
- 1 rasgador para a extracção suave das linguetas para cola.
- 8 barras de cola preta (11 x 200mm).
- 19 linguetas para cola em vários tamanhos e formas.



### DESMANCHA DISPONÍVEL

REF.	DESCRIÇÃO	3	5	40	€
13842	Saco de 5 discos azuis 0,15	10	100		8,50€
13843	Saco de 4 discos amarelos 0,1	10	100		7,00€
13844	Saco de 10 discos vermelhos 0,3	10	100		9,00€
13845	Saco de 5 barras de cola 0,95	10	100		8,00€



13842



13843



13844



13845

## ECRÃ PARA INSPEÇÃO DE AMOLGADELAS

53486

28,00€

0,3

10

40

320

- Permite detectar qualquer amolgadelas, grande ou pequena, de maneira muito fácil e perceptível, em qualquer parte da carroceria com o seu desenho linear.

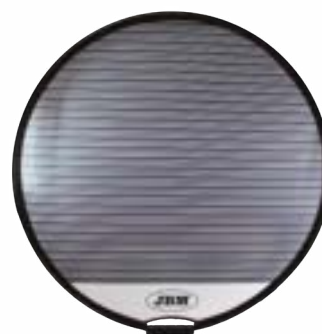

Ø 800mm

## PUNÇÕES

Permitem a aplicação de marcação digital ou alfabética em qualquer superfície de metal por método de indentação ou impacto. A área de trabalho arredondada evita rachaduras ou fraturas na superfície tratada.

### LETRAS E NÚMEROS

52422

24,00€

0,82

3

6

540

36  
PCS

3/16"



5mm

A-Z & 0-9

53119

45,00€

1,94

3

6

504

36  
PCS

5/16"



8mm

A-Z & 0-9

### NÚMEROS

52882

14,00€

0,30

10

60

1.500

9  
PCS

1/4"



6mm

0-8

## KIT ENCONTRADORES PARA CHAPEIROS

52876

182,00€

3,13

6

84

7  
PCS



REVESTIDO DE PLÁSTICO



12959



12955



12956



12957



12958



12960



12961

### DESMANCHA DISPONÍVEL

REF.	DESCRIÇÃO	3	6	84	€
12955	Encontrador tipo bigorna	0,29	-	25 99	27,80€
12956	Encontrador tipo rail	0,31	-	25 99	27,80€
12957	Encontrador tipo rail	0,37	5	25 99	27,80€
12958	Tas mango con cuña	0,41	-	25 -	27,80€
12959	Tas en coma	0,3	5	25 99	27,80€
12960	Tas de tación	0,18	-	25 1.500	27,80€
12961	Tas de coma con mango	0,34	-	25 -	27,80€



## CONJUNTO DE MARTELOS ESPECIAIS PARA CHAPA



51131

56,00€

5 5 100

7  
PCS



11544



11541



11542



11543



11545



11546



11547

### DESMANCHA DISPONÍVEL

REF.	DESCRIÇÃO	📦	📦	📦	€
11541	Martelo boca plana	0,43	5	25	8,00€
11542	Martelo boca plana/peña	0,38	5	25	7,50€
11543	Martelo boca plana cônica	0,42	5	25	7,50€
11544	Tas tacão	0,69	5	25	6,50€
11545	Tas aleta	0,79	5	25	9,50€
11546	Tas dois cantos romo	0,81	5	25	6,50€
11547	Tas cunha em 8 o carril	0,81	5	25	6,50€

## CONJUNTO DE RESTAURAÇÃO DE FARÓIS

53673

98,00€

2,20 10 80

- O kit de reparo de faróis de polímero líquido é um sistema inovador para restaurar os faróis queimados até a sua condição original com um brilho original e uma aparência perfeita de uma maneira muito rápida e econômica.

- Completez:  
 Recipiente para líquido de 600 ml  
 6 folhas de lixa  
 Papel texturizado  
 Funil de plástico  
 Tampa curva com anel de vedação de borracha  
 Tampa plana com anel de vedação de borracha  
 Adaptador ac-dc  
 Adaptador 12v  
 Copo de evaporação  
 Placa de moagem



14572

38,00€

GARRAFA  
COM LÍQUIDO  
600ml

O kit de reparo de faróis de polímero líquido é um sistema inovador para restaurar os faróis queimados até a sua condição original com um brilho original e uma aparência perfeita.

0,85 4 24 600

BRILHO ORIGINAL E UMA APARÊNCIA PERFEITA



### DESMANCHA DISPONÍVEL

REF.	DESCRIÇÃO	📦	📦	📦	€	REF.	DESCRIÇÃO	📦	📦	📦	€	REF.	DESCRIÇÃO	📦	📦	📦	€
14564	Kit de 6 papéis abrasivos	0,10	10	100	9,20€	14568	Tampa curva com anel de vedação de borracha	0,1	10	200	9,20€	14571	Placa de moagem	0,05	10	100	9,20€
14565	Adaptador ac-dc	0,20	10	50	26,70€	14569	Tampa plana com anel de vedação de borracha	0,1	10	200	9,20€	14572	Garrafa com líquido 600ml	0,70	4	24	38,00€
14566	Adaptador 12v	0,05	10	100	16,70€	14570	Funil	0,01	10	200	4,05€	14573	Papel texturizado	0,01	10	100	4,05€
14567	Copo de evaporação	0,15	10	20	37,95€												

### CONJUNTO DE 10 ELEMENTOS DO PAPEL ABRASIVO

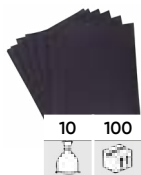

GRÃO 180	GRÃO 280	GRÃO 360	GRÃO 600	GRÃO 800	GRÃO 1200
14710 0,25 3,50€	14711 0,20 3,75€	14712 0,20 4,00€	14713 0,15 4,25€	14714 0,15 4,50€	14715 0,10 4,75€

## KIT DE RESTAURAÇÃO DE FARÓIS

53626

17,00€

0,30 12 624

- Projetado para restaurar a clareza das lentes dos faróis que ficaram amarelas, nubladas ou turvas.  
 - Melhora o desempenho das lentes dos faróis.  
 - Três passos simples: lixar, polir e proteger.  
 - Restaura faróis dianteiros, lanternas, faróis de neblina ou sinais de direção.  
 - Este kit é feito para restaurar 2 faróis.

- Contenido del kit:  
 2x P800 Discos de lixar.  
 2x P1200 Discos de lixar.  
 2x P2000 Discos de lixar.  
 1x 85gm Pasta de polimento.  
 2x 3.0ml Líquido protetor UV.  
 1x Fita adesiva.  
 1x Disco de polimento de lã.  
 1x Disco de Esponja Branco.  
 1x Almofada de suporte M10 Rosca.  
 2x Adaptador (3/8" & 1/4").



EM EXPOSIT-  
TOR  
DE 12 UDS

## CAPACETE PARA SOLDAGEM COM REGULADOR MANUAL

53414

61,00€

0,85 6 40



## CAPACETE PARA SOLDAGEM COM REGULADOR DIGITAL

53415

181,00€

0,95 4 40



## CINTO DE SEGURANÇA PARA AUTOCARROS

### CINTO DE 2 PONTOS

50644

11,60€

0,40 40 1.600



CUMPRE COM: E4-16R-0436213

### CINTO DE 2 PONTOS ENROLÁVEL

50717

21,00€

0,75 10 20 500



CUMPRE COM: E8-16R-0812201

### CINTO DE 3 PONTOS ENROLÁVEL

51266

27,60€

1,13 20 320



CUMPRE COM: E4-16R-0436275

## JOGO DE 4 PALANCAS EXTRALARGAS

52977

120,00€

8,61 1 48

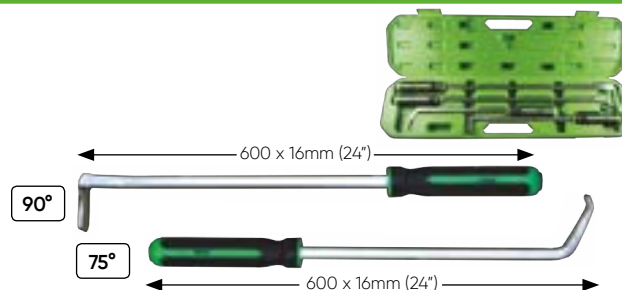
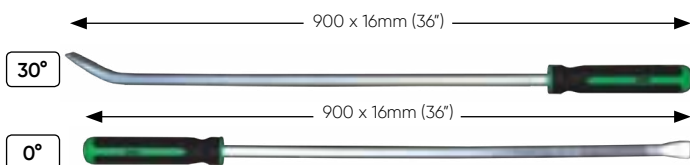

## JOGO 27 PALANCAS DE NYLON

52788

39,00€

1,18 10 140



- Set 27 alavancas com diferentes curvaturas e terminações que facilitem o trabalho tanto em ambientes internos e ao ar livre de veículos. A sua vasta gama permite que você use a ferramenta certa para cada trabalho e peça, facilitando o trabalho em locais de difícil acesso.



## JOGO DE 5 PALANCAS DE NYLON

50901

16,00€

0,04 5 20 240



- Universal
- Com punho 6 x 160mm
- Uso práctico 63 x 175 mm
- Especiais zonas estreitas 30 x 200mm
- Tapicerias 20 x 180mm
- 20 x 215mm



## JOGO DE 4 PALANCAS DE NYLON TIPO FACA

51832

0,55 6 24 192

18,00€



19x273, 22x273, 25x273, 38x273mm



## JOGO 2 PALANCAS EXTRAIR PEÇAS DE AUTOMÓVEL

52851

0,24 6 60 800

8,10€

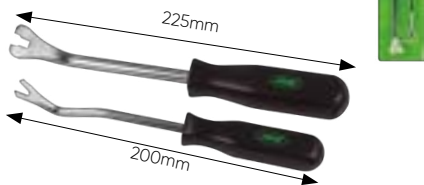

## JOGO DE 2 PALANCAS DE FERRO

52026

2,04 5 10 210

25,55€

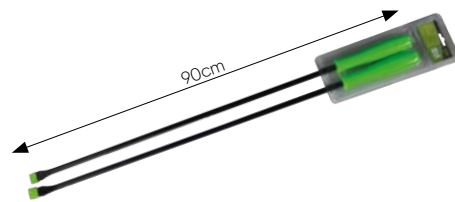

## JOGO DE 5 PALANCAS DE FERRO

50903

1,95 4 8 200

23,80€



60, 43, 38, 28, 18cm

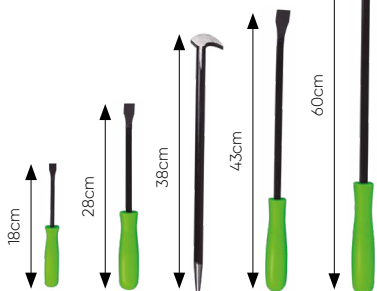

## JOGO DE 6 PALANCAS

53110

1,42 6 12 144

22,00€



6 PCS

5"x8.5 / 5"x10.3  
5"x4.5 / 15"x8.5  
15"x10.3 / 15"x4.5mm



## PÉ-DE-CABRA

51360

51361

6,00€

9,80€



0,75

5

20

18" x 5/8



1,46

5

10

500

24" x 3/4

FABRICADO EM AÇO

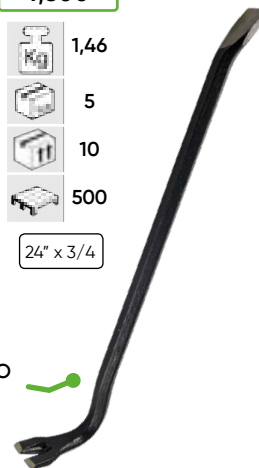

## JOGO DE UTENSÍLIOS PARA ABRIR CARROS

53230

0,65 24 360

19,00€



UNIVERSAL

8 PCS

- Kit de ferramentas especiais para abrir veículos sem chave.
- Composto por cunhas de plástico, alavancas e ganchos curvos.
- Contém chave universal para coberturas de depósito de combustível.
- Para uso em oficinas e assistências.

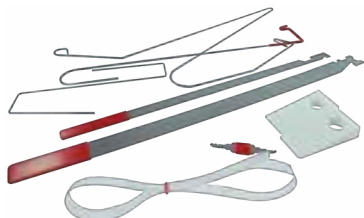

## KIT DE 4 ALMOFADAS INSUFLÁVEIS

52077

0,35 5 40 240

29,50€



40-50mm

- Introdução entre o vidro e a porta, permite abrir o veículo facilmente sem estragar.

- Contém:  
Almofada de 16x16cm  
Almofada de 32x12cm  
Almofada de 19x6cm  
Almofada de 18x4,5cm  
Bomba manual  
- Pressão máxima suportada: 100kg



PARA REF. 53232

## CABO PARA EXTRAÇÃO DE PÁRA-BRISAS

13813

0,1 10 60

6,00€



## FERRAMENTA PARA EXTRAÇÃO DE PÁRA-BRISAS

13814

0,2 10 60 840

10,00€



## FERRAMENTAS PARA SUBSTITUIÇÃO DE LUAS

53232

1,15 10 160

39,00€



- Contém:  
1x útil extrator de molduras.  
1x alavanca para extrair a borracha.  
1x gancho extrator.  
1x 1.8m de fio de corte.  
2x cabos para o fio de corte.  
1x Passa-cabos.

## 5 PEÇAS DE SOQUETES HEXAGONAIS 3/8" - EXTRA LONGOS

53545

0,74 5 20 600

33,50€



5 PCS

3/8"

8, 10, 12, 13, 14mm

Cr-V BMW, FORD, OPEL, VAG, VAUXHALL



- Permite ajustar o freio de estacionamento em BMW, FORD OPEL, VAG e VAUXHALL.
- Util para dobradiças de porta, pára-choques e luzes traseiras. Também é usado para freios de mão.

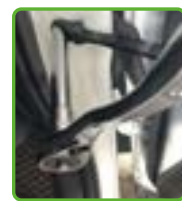



# ALICATES

**53675**

43,00€

0,75



DIRECTAS

10"

**53676**

38,00€

0,85



CURVAS

**53677**

47,50€

0,90



ALMOFADA GIRATÓRIA

**53678**

44,50€

0,90



CURVAS LONGAS

10 20 300



53675

53677



53676

53678

REF	←	→	
53675	250mm	70mm	
53676	250mm	90mm	
53677	250mm	80mm	
53678	300mm	105mm	



EM EXPOSITOR DE 10 UDS



## ALICATE PRESSÃO PESCOÇO DE CISNE

**52505**

18,00€

0,27

5

40

2.160



Apresentação em caixa

170mm



CrMo

0-40mm



## ALICATE PRESSÃO PESCOÇO DE CISNE, MAXILAS OSCILANTES

**52506**

16,00€

0,29

6

48

2.160



Apresentação em caixa

170mm



CrV

0-50mm



## ALICATE DE PRESSÃO SOLDADURA, MAXILAS OSCILANTES

**52512**

44,50€

1,32

20

280



Apresentação em caixa

440mm



CrMo

0-210mm



## ALICATE DE PRESSÃO PARA SOLDADURA

**52511**

40,50€

1,32

20

280



- Apresentação em caixa

440mm



CrMo

0-225mm



## ALICATE DE PRESSÃO PARAGRAFO LATOEIROS

**52507**

27,00€

0,77

30

420



- Apresentação em caixa

250mm



CrMo

0-80mm



## ALICATE DE PRESSÃO TIPO U

**52504**

25,00€

1,14

30

480



- Apresentação em caixa

225mm



CrMo

0-60mm



## ALICATE DE PRESSÃO PESCOÇO DE CISNE MAXILAS OSCILANTES

**52503**

29,50€

0,85

10

30

540



- Apresentação em caixa

280mm



CrMo

0-105mm



## ALICATE DE PRESSÃO PARA SOLDADURA

**52510**

28,50€

0,47

10

50

1.500



- Apresentação em caixa

285mm



CrMo

0-150mm



## ALICATE DE PRESSÃO PARA SOLDADURA

**52502**

28,00€

0,84

10

30

540



- Apresentação em caixa

280mm



CrMo

0-110mm



## JOGO DE 6 ALICATES DE SOLDADURA

52385

219,50€



Tipo W: 195mm



Tipo T: 215mm



Tipo L: 225mm



Tipo J: 210mm



Tipo LL: 195mm



Tipo JJ: 195mm

TIPO W 195mm

14103 28,00€

TIPO T 215mm

14104 28,00€

TIPO L 225mm

14105 28,00€

TIPO J 210mm

14106 28,00€

TIPO LL 195mm

14107 28,00€

TIPO JJ 195mm

14108 28,00€

## JOGO 3 ALICATE PRESSÃO EXTRA-LARGAS

52982

49,00€



37cm: punta recta  
36cm: ángulo de 45°  
34cm: ángulo de 90°

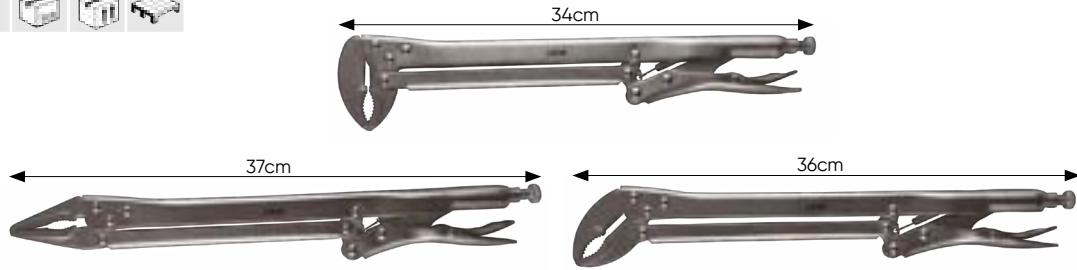

## ALICATE PRESSÃO

50577

12,00€



CrV 280mm

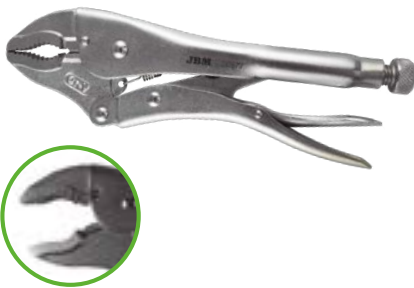

## ALICATE DE PRESSÃO CURVADO

52386

22,00€

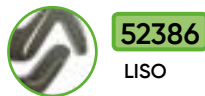

52386 LISO

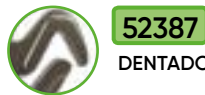

52387 DENTADO

52387

22,80€



CrMo

215mm



- Agarre em 6 medidas distintas de fêmea / parafuso hexagonal.

## ALICATE ESPECIAL SOLDADURA

52390

31,00€



250mm CrMo



## ALICATE ESPECIAL EMBRAIAGEM

52388

24,50€



305mm CrMo



ACAVADO EM ÂNGULO

### GANCHO DE MOLA

52477

2,60 10 1.500

61,00€



0-60mm



### GANCHO 90°

52478

2,75



49,00€



0-20mm



### MINI GANCHO PLANO 90°

52479

1,18 30

40,80€



0-20mm



### GANCHO DE ARGOLA

52474

3,49 5 1.500

57,50€



0-20mm



### GANCHO PLANO

52475

3,60 10 1.500

54,50€



0-25mm



### GANCHO QUADRADO

52476

3,04 6 1.500

49,80€



0-25mm



### MINI GANCHO QUADRADO 90°

52480

2 10

43,80€



0-25mm



### GANCHO QUADRADO

52481

1,91 9 1.500

46,00€



0-20mm



### GANCHO PLANO ANGULO 45°

52482

2,13 12 1.500

43,80€



0-10mm



### GANCHO PLANO MINI

52483

2,02 12 1.500

40,80€



0-10mm



### GANCHO DE MOLA

52487

2,27 9 1.000

55,00€



0-20mm



### UNIÃO DE CORRENTES

52484

1,19 11 1.500

56,50€



0-110mm



### UNIÃO DE GANCHOS

52485

1,17 11 1.000

46,50€



0-90mm



### UNIÃO DE CORRENTES GANCHOS

52486

1,21 11 1.500

51,50€



0-110mm



MORDAÇAS



## PISTOLA DE SILICONE PROFESSIONAL

52533

10,00€



9"

300ml

## SERINGA PNEUMÁTICA PARA SELAGEM

53567

40,00€



- Pressão de trabalho: 2,5-5 BAR.  
- Entrada de ar: 1/4".  
- Capacidade do cartucho: 310ml.

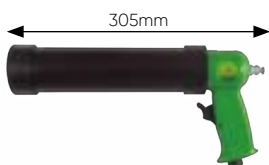

310ml

## KIT DE DUAS MINI VENTOSAS

52295

6,50€



5KG

Ø 60mm



## VENTOSA EXTRAÇÃO COM CABO

52589

12,50€



8KG

Ø 70mm

VENTOSAS

## VENTOSAS

### ÚNICA

52262

7,50€



40KG

Ø 115mm



### DUPLA

52263

13,50€

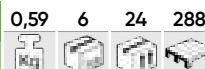

70KG

Ø 115mm



### TRIPLE

52264

23,00€



100KG

Ø 115mm



### QUADRÚPLA

52265

30,50€



120KG

Ø 115mm



## VENTOSA DUPLA ARTICULADA

52765

21,50€

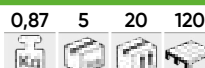

100KG

Ø 115mm

- Destinase a manutenção, instalação e remoção de partes do veículo, tanto a folha de metal e vidro.  
- Facilidade de manipulação e se conforma com a curvatura do potencial de superfície.



## JOGO DE VENTOSO E CATRACA

52998

55,15€



80KG

Ø 120mm



5m x 25mm

## CINTA DE APERTO POLIÉSTER COM TENSOR

52321

0,4 5 20 1.200

5m x 25mm

8,80€



52327

0,46 5 20 1.000

8m x 25mm

12,00€

## SUPORE DE PEÇAS - PÁRA-BRISAS E COBERTURA

53983

19,40 1 35

214,50€

- Disponível para pára-brisas, chapas metálicas, capôs, portas ... etc.

150  
KG

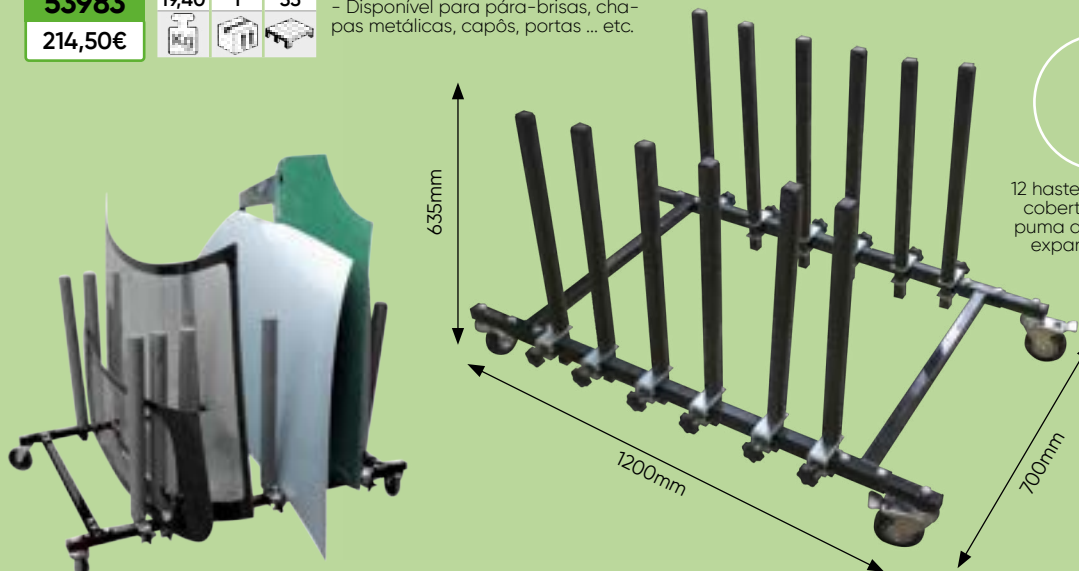

12 hastes de 630 mm cobertas com espuma de polietileno expandido (EPE)

Até 5 grandes painéis ou vidros

Rodas de poliuretano (PU) 4 "x 4" (duas giratórias com freio)

## CARRO PARA ARMAZENAGEM DE PEÇAS

53125

51 1 12

477,00€

1.800mm

895mm

585mm

200  
KG



4x INCLuíDO

# CAVALETE UNIVERSAL TELESCÓPICO

53124

21,10 1 11

286,50€



100  
KG

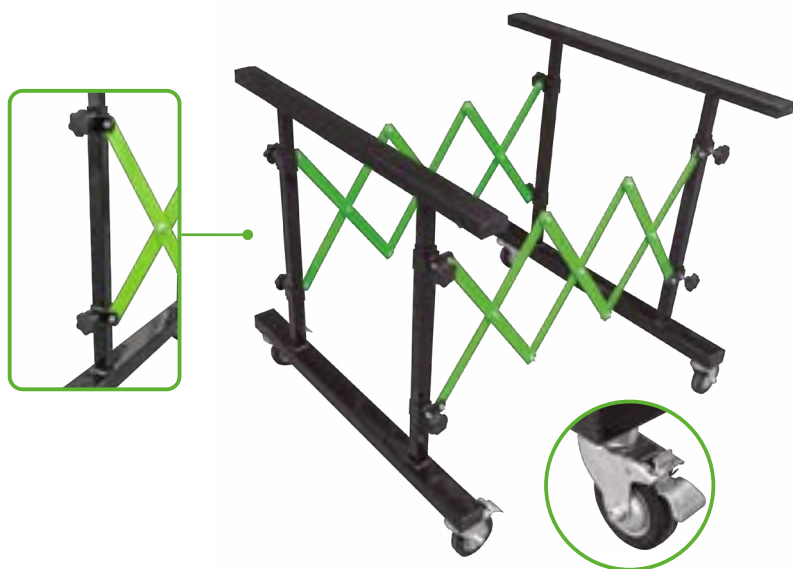

MEDIDAS ALTO

↑ 1.320mm  
↓ 840mm

MEDIDAS LONGA

↑ 1.380mm  
↓ 225mm



## PREGUIÇA PARA PARABRISA

53080

7,87 1 45

99,00€



70  
KG

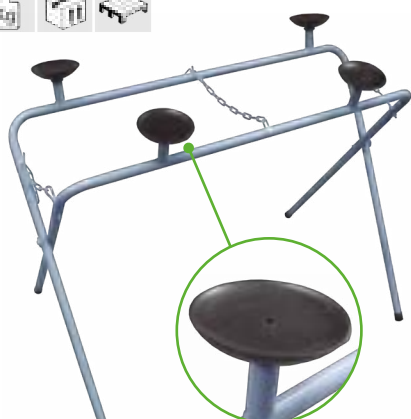

CAVALETE DE MONTAGEM COM VENTOSA DE BORRACHA MACIA

MEDIDAS DOBRADO

1.130mm 990mm

## CARRO TRANSPORTADOR ESPECIAL CHAPEIROS

50923

32,9 1 15

390,00€



480mm 1.300mm 800mm

- Separação de 0 a 110 cm.

340  
KG

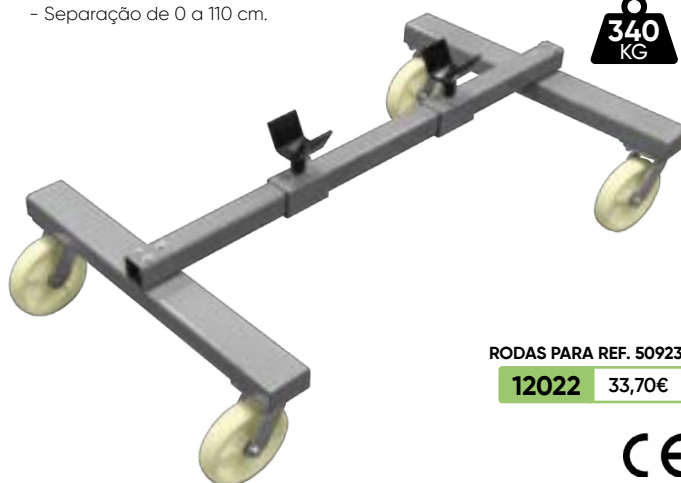

RODAS PARA REF. 50923

12022 33,70€

CONSUMÍVEIS DE OFICINA

## PREGUIÇA PROFESSIONAL

52749

6,25 1 29

79,00€



80mm 58mm

220  
KG



FOAM PARA PREGUIÇA  
REF. 52749

11959

0,08 100

10,50€



## CAVALETE EN "X"

53079

6,77 1 44

89,00€



100  
KG

MEDIDAS DESDOBRADO

660mm 600mm 870mm

MEDIDAS DOBRADO

1140mm 600mm 300mm

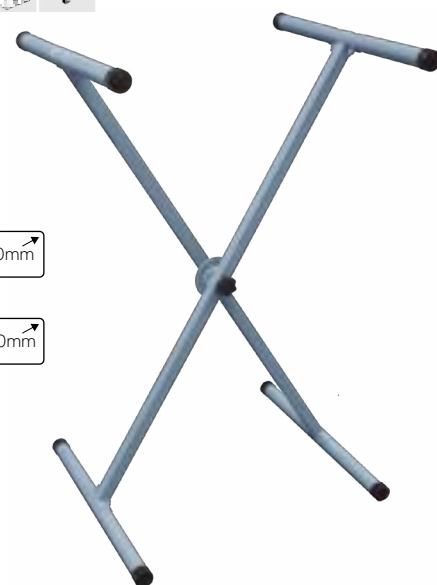



## CAVALETE SUPORTE PARA-CHOQUES

**53736**

97,50€

8,10

1

42



- Ideal para fixar pára-choques, para pintar e repará-los com maior conforto.

- Largura ajustável: 75 cm - 160cm.  
- Altura máxima: 148cm.



A LARGURA AJUSTÁVEL PERMITE QUE O SUPORTE SEJA ADEQUADO PARA SUPORTAR VÁRIOS TIPOS E ESTILOS DE PÁRA-CHOQUES

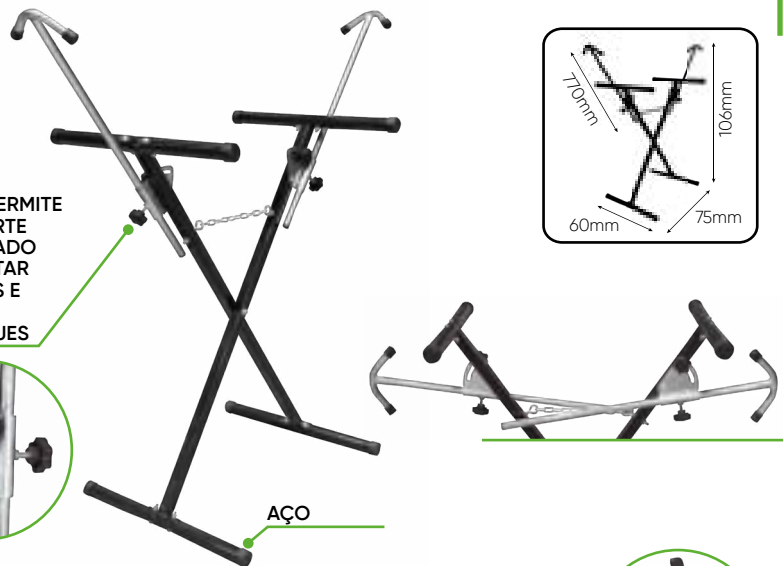

AÇO

**53685**

310,00€

14,50

1

14



1.110mm

760mm

1.340mm

- Sustenta qualquer pára-choque sem tocar na superfície pintada  
- Facilita e agiliza os reparos e pinturas  
- Giro de 90 graus permite fácil acesso a todas as superfícies  
- Cinco posições diferentes de bloqueio  
- Quatro rodas de qualidade industrial, com bloqueio total para a estabilidade



AJUSTE DOS BRAÇOS DE SUPORTE DE 134 - 198cm

AÇO COM COBERTURA DE PÓ

4 RODAS DE 4 POLEGADAS (DUAS GIRATÓRIAS COM TRAVÃO)

## SUPORTE PARA PINTURA AJUSTÁVEL

**53134**

116,50€

14,7

1

36



1.770mm

500mm

150 KG

- 6 ganchos para segurar peças para pintar ou secar.  
- Marco ajustável que se estende de 127 cm a 203 cm.

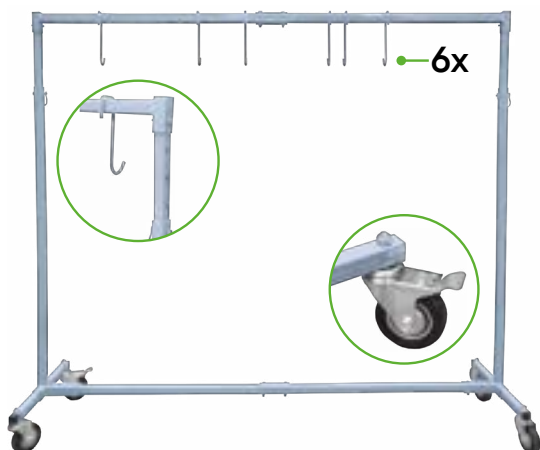

6x

## SUPORTE BASCULANTE PARA PINTURA

**53126**

243,00€

20,3

1

24

50 KG

- Ideal para portas, capôes, pára-choques, alertas, spoilers, etc.

- 6 braços de fixação:  
4 com gancho fixo  
2 com buraco

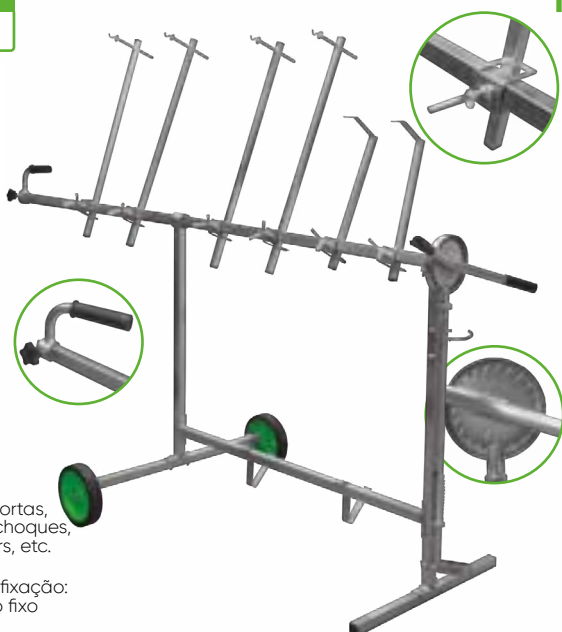

## SUPORE DE REPARO DE BICICLETAS

53919

85,00€



- Material: aço Q195, ABS, nylon
- Dimensões montadas: 198x104 cm
- Altura ajustável: 107-188 cm
- Comprimento do tubo transversal giratório: 37 cm
- Comprimento do suporte: 69 cm
- Diâmetro do tubo transversal giratório: 35 mm
- Diâmetro do tubo telescópico: 35 mm
- Diâmetro do tubo principal: 38 mm
- Diâmetro do tubo de suporte: 25 mm
- Capacidade máxima de levantamento: 30 kg



HASTE AJUSTÁVEL DE FIXAÇÃO: 50-90CM

PARA TODOS OS TIPOS DE BICICLETAS  
CIDADE / ESTRADA / MONTANHA



GRAMPO AJUSTÁVEL DE LIBERAÇÃO RÁPIDA (360°)



De material reforçado ABS e de nylon para girar a bicicleta em qualquer ângulo e sem danificar a pintura.



DIMENSÕES DA BANDEJA MULTIFUNÇÃO DE FERRAMENTAS 25x13cm



DESIGN ANTIDERRAPANTE 4 PÉS

## SUPORE DE PAPEL PARA PAREDE

53922

23,50€



PAPEL NÃO INCLUSO

- Aço inoxidável
- Rolo: max. largura 38 cm
- Braçadeira-plástico ABS, cinzento.
- Parafusos e porcas de fixação em aço inoxidável.



## PORTA BOBINA DE PAPEL

53921

35,00€



PAPEL NÃO INCLUSO



- Material: aço inoxidável
- Rolo: max. largura 38 cm
- Braçadeira - plástico ABS

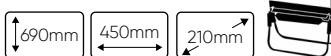
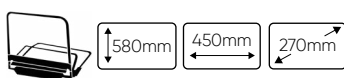

## BOBINA COBRE ASSENTOS

MODELO CUIDAMOS (CASTELHANO) / SEM SAIA

51978

79,00€



25mc

250 u.

MODELO DESENHO ANÔNIMO / SEM SAIA

52244

79,00€



25mc

250 u.



ÂMPLA COBERTURA DO ASSENTO

51978

52244

25 MICRONS DE ESPESURA

## KIT EXPOSITOR + MATERIAL DE CUIDADO DO VEÍCULO

COMPOSTO POR REF.  
52065, 52244, 52057, 52058

**50403**

8,9 1 70

99,00€



COMPOSTO POR REF. 51985,  
51978, 52057, 52058, 50409

**50400**

17 1 35

158,00€



COMPOSTO POR REF. 51985,  
52244, 52057, 52058, 50409

**50410**

12,44 1 35

158,00€



## EXP. PAREDE DE BOBINA COBREASSENTOS, ROLO VOLANTE E TAPETES PAPEL

**53705**

5,02 1 40

105,50€



**51985**

5,02 1 40

109,00€

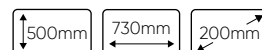

- Suporte da tampa do pé.
- Suporte da tampa do assento.
- Suporte para lidar com a tampa do filme.

## EXPOSITOR PAREDE DE BOBINA COBRE-ASSENTO

**52065**

2,19 1 70

44,50€



## ROLO DE FILM PARA VOLANTE

FILM

**52057**

0,62 24 600

6,80€



- Comp. 200m
- Larg. 12,5cm
- Grosso: 23mc

CABO

**52058**

0,06 125 2.500

4,50€



## TAPETE ANÔNIMO EM PAPEL

**50409**

3,54 250 160

26,00€



250 UDS

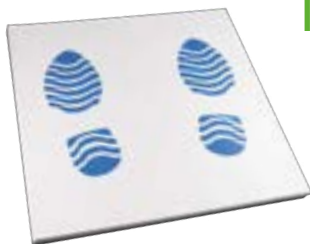

## PROTECTOR DE VOLANTE PLÁSTICO

**51824**

1,45 8 72

38,00€



250 UDS



## KIT MANUTENÇÃO DE LIMPEZA EM BOLSA INDIVIDUAL

**50916**

0,07 100 400 3.200

0,88€



DISPENSADOR

5in1

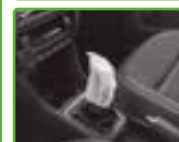

TAPETE PARA PÉS DE PAPEL





## TAMPA DO CARRO

53226

13,50€

0,3 5 50 900



- Nylon.  
- Universal.



## PROTECTOR COM IMÁN

51622

19,90€

0,45 30 540



110cm

64cm



4 PONTOS  
MAGNETIZADOS

DUAS FACES:  
UM VELUDO /  
UM PLÁSTICO



## LUVAS COM PALMA REFORÇADA DE POLIURETANO

2,00€

0,03 12 144 3.456



- 51640N T. 8
- 51642N T. 9
- 51636N T. 10
- 51638N T. 11



## LUVAS COM PALMA REFORÇADA DE NITRILÓ

2,00€

0,04 12 144 3.456



- 51633 T. 8
- 51634 T. 9
- 51632N T. 10
- 51398N T. 11



## TAPETE

DESDOBRÁVEL

53192

49,00€

0,7 2 80



- De espuma EVA.  
- Medições do colchão dobrado:  
20cm x 40,5cm x 12,5cm.

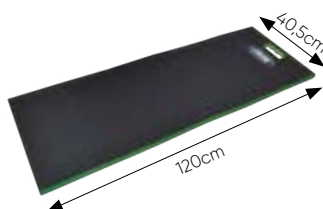

INDIVIDUAL

53191

14,80€

0,15 5 215



32cm

48cm



- De espuma EVA.



IVA não incluído

JBM

www.jbmcamp.com

173

CONSUMÍVEIS DE OFICINA

## PLATAFORMA DE ALUMÍNIO TELESCÓPICA

**52230**

**295,00€**

16,75 1 14

**150 Kg**

CUMPRE COM: EN 131

- Largura da plataforma: 300mm.
- Altura ajustável da plataforma: 520-900mm.
- Largura da barra: 40mm.
- Distância entre as barras: 250mm.

- Posições: 42 (14 de horizontais x 3 de verticais).  
 Altura 1 : 520mm.  
 Altura 2 : 700mm.  
 Altura 3 : 900mm.

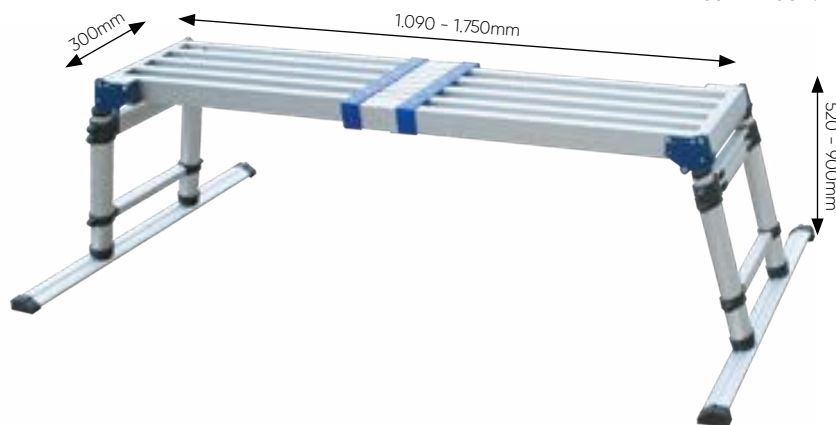

**SUPER LEVE**



**FÁCIL MONTAGEM**

**DOBRAGEM**



**PÉ DE RECAMBIO PARA PLATAFORMA REF. 52230**

**10966**

0,06 1

**13,50€**

**PROTECTOR CANTOS PLATAFORMA REF. 52230**

**10965**

0,01 1

**6,00€**

**TIPO DE ESCADA PARA PLATAFORMA REF. 52230**

**10964**

0,01 1

**9,00€**

## PLATAFORMA DE ALUMÍNIO GRANDE

**50913**

**169,00€**

6,5 1 20

**100 Kg**

CUMPRE COM: EN 131

800mm 1400mm 300mm

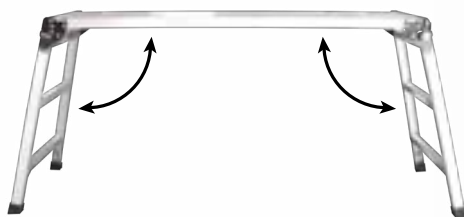

## JOGO DE 2 PLATAFORMAS DE ALUMÍNIO

**50656**

**250,00€**

10,45 1 12

**100 Kg**

CUMPRE COM: EN 131

**PLATAFORMAS DE ALUMÍNIO**

**15552**

550mm 1300mm 300mm

**181,00€**

**11897**

300mm 1000mm 300mm

**155,00€**

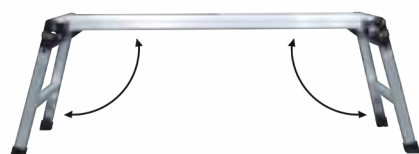
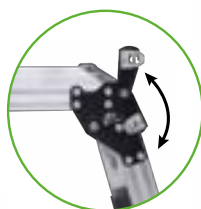

RECOLHA DE EMBOLOS



REPARAÇÃO / MANUTENÇÃO



SANGRADOR DE TRAVÕES



176



177



# TRAVÕES

178





## FERRAMENTA PNEUMÁTICA PARA RECOLHA DE EMOLOS DE TRAVÕES PERFIL BAIXO

53683

1,45 5 10 120

106,00€



- Pressão normal de uso: 5-8bar.  
- Máxima de trabalho: 14bar.



## FERRAMENTA PNEUMÁTICA PARA RECOLHA DE EMOLOS DE TRAVÕES

51283

1,33 10 120

66,50€



- Pressão normal de uso: 5-8bar.  
- Máxima de trabalho: 14bar.



## CONJUNTO DE RECOLHA DE EMOLOS DE TRAVÕES

52636

3,16 5 75

111,00€



16  
PCS

0: GM Maior parte dos Pistões De 2-1/2" de diâmetro (Seville/Eldored 79)  
2: Citroën Xm/Xantia (F/R), Honda  
3: Audi (F), Fiat, Alfa Romeo (F), Ford Fiesta (F), Isuzu (F), Honda Concesto (F), Jaguar Xj6/Xj40 (F/R), Bmw 318is/320i/325td/518i/525i-1x/740i/850Ci/M5 (F), Mercedes Benz 190/200/300/420/560 Serie (F), Mitsubishi Colt (F), Nissan Miera/Stanza/Sunny (F), Rover Austin/Metro200-400 Series/Maestra/Montego (F), Toyota Camry (F), Volvo (F), Vw Passat/Golf Gti (F)  
4: Ford Australia/Nz Telstar, Mazda (R), Saab 9000 (R)/Lumina, Toyota, Fiat 164 2.0 (R), Alfa Romeo Prelude/Crs 16i, Honda Saturn (R)/Grand Prix, Gm  
5: Adaptador de 3/8" de diâmetro usado com uma barra de extensão e garra de travacção se for necessário aplicar mais força ao pistão.  
6: Nissan Primera, Vw Golf IV  
7: Audi 80/90/V8+100/Coupe E (R), Rover 800 Abs, Subaru L+Z (R), Ford Sierra Abs/Granada/Scorpio Abs (R), Nissan Bluebird 1.8 Turbo/Silvia Turbo/

Primera2.0i Ls-Gs-Gsx (R), Peugeot 405 19Gi/Gri/Sri/Gtxi/Mi 16/605 2.0 Sri (R), Toyota Cecilia/Corolla Gt/Mr2 (R), Vw Golf Gti/Jeta Synchro/Jetta Gti 16V, Passat Cl, Gl, Gt, Gt 16V, Corrado 16V Scirocca Gtx 16V(R), Citroën, Alfa Romeo, Fiat, Honda, Jaguar, Renault, Saab, Seat, Lancia.  
8: Gm Maior Parte Dos Pistões De 2-1/8" De Diâmetro  
9: Gm Maior Parte Dos Pistões De 2-1/8" De Diâmetro  
A (Z): Renault (R21-Laguna (R))  
E: Nissan Maximas/Cefiro  
F (G): Opel (Disco Traseiro)/ Fiat Stilo  
K: Citroën C5  
M: Ford, Mini Cooper, Nissan Primera 03  
N: Saab, Honda, Alfa Romeo 164 2.0 Twin Spark/2.0 Turbo (88-)/3.0 V6, Audi 200 (80-)/Coupe Gt Se (82-)/80/90/1Qa/200/Quattro (87-)/90/20V (88-), Ford Mondeo 2.0/Ghia, Lancia Themaalte (85-), Volkswagen Golf Ii Gti (83-87)/Siocco 16V (84).

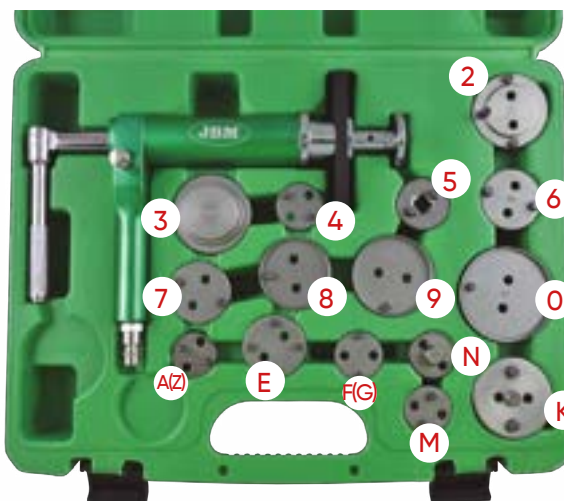

## CONJUNTO DE RECOLHA DE EMOLOS PARA TRAVÕES

52330

5,68 4 60

100,50€



OPEL  
CITROËN

PEUGEOT  
RENAULT

50  
PCS

1pc: Grampo de rotação direita (com rosca à direita)  
1pc: Grampo de rotação esquerda (com rosca à esquerda)  
0 disco: Citroën 1: Disco 11: Disco para Jaguar tipo S  
12: Disco para BMW mini 5: 13/32" Adaptador (5) com 3/8 Dr. Interior-pt  
2: Citroën XM, Xantia u.a. 3: Alfa Romeo.Audi. Austin. BMW. Ford. Honda. Jaguar. Mercedes-Benz. Mitsubishi, Nissan Rover, Toyota, VW  
4: Alfa Romeo 164 2.0.Ford, Mazda, Saab 9000, Subaru  
6: Nissan Primera, VW-Golf IV  
7: Audi 80,90,V8 +100, Ford Sierra ABS+ Scorpio ab 85, Honda Prelude, Nissan Silvia 1.8 turbo, Rover 8000, Saab 9000, Subaru L+Z, VW-Golf+ Passat  
8: GM Motors G: Opel 9: GM Motors K: Citroën C5  
0: GM Motors K1, K2: Citroen, Renault. M: Ford  
A: Nissan Primera 2.0, Bluebird N: Saab. Honda B: Ford, Lincoln, Subaru Z: Renault C: Mini Austin E: Cefiro, Maxima D: Citroën, Renault  
F: Peugeot 206 CC/Hai/Gti. Ela exige uma chave de 16mm com pistões traseiros.  
P: Audi, BMW, Ford, Lancia, Piston, Renault, Rover  
J: Alfa Romeo 155 1.8-2.0 164 TD(93) 164 3.0 V6(91), Audi 80,90,A3,A4,A6,A8, Citroen ZX 2 Qi 16V, Fiat Tipo TD 16V, Uno Turbo (85) Crama TD, Ford Sierra ( ABS bak). Granada (85) Crama TD, Ford Sierra (ABS bak). (Australia& NZ) Thunderbird Turbo, Honda CRX, 1.6i-16V (8-90). Accord 1800 (84-85) 2.0i. Prelude 16V (88), Legend V6, Jaguar XJ 4, Oseries, Lancia Dadra 2.0, Ei Tur (93), Delta 1.6 Gti, Nissan, Peugeot, Renault, Seat, Subaru, Volvo V40 6S40.  
R: Ford (Australia& NZ) Teslar, Laser, Mazda 323 Gti, GTXX (86-), 929 (82-), RX7(81-), 626 16V(87i) 626 GT (86-), 929 V6 (88-), Mitsubishi Galant GL Si, Toyota Celica, Corolla GT, MR2  
S: Audi 100 TQ(91), BMW 740i 8cyl (91), Lancia Delta 19 TD (95), Proton 416. Renault-most models, Renault Laguna 2.0 (94). Laguna 2.2 D (95) Safrane 2.0-2.2 TD V6, Rover 623 Si, Volkswagen Golf Gtu Mk I&IV, Passat VR6, Vento GT (92)  
H6: BMW  
H7: BMW  
Pin 3.0  
Pin 5.5  
100g Grasa  
1/2"Dr+10mm Pentagon bit-56mm Sistema de freios  
1/2"Dr+14mm tipo macho-38mm- para freios pentágono nos freios traseiros do Opel Astra G, Zafira, Smart  
1/2"Dr+19mm tipo macho-8mm- para freios Bendix, Citroën, Peugeot, Renault  
P1: Peugeot 307,308.

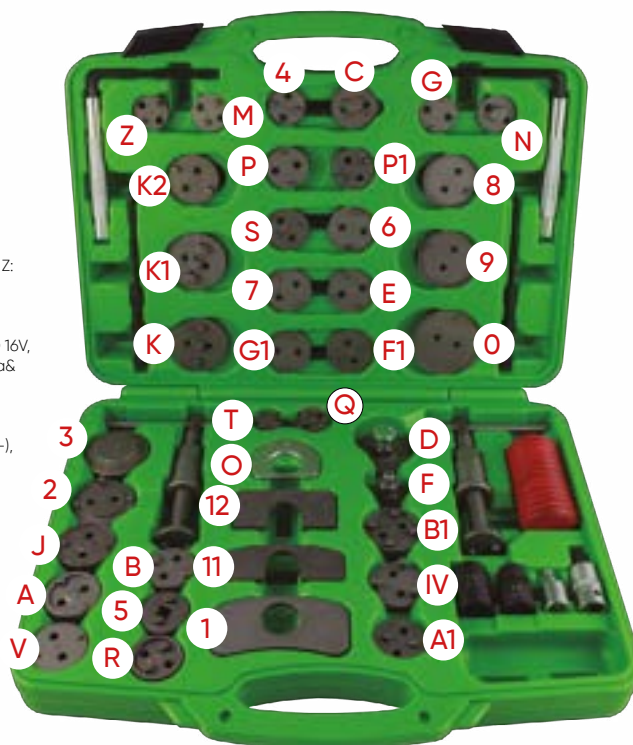

## CONJUNTO DE RECOLHA DE EMBOLOS PARA TRAVÕES

51059

94,50€



- Sistema de múltiplo uso com 37 peças para repar os embolos de travões.
- Útil para a maior parte de veículos.
- Contém:
- 2x chaves hex. de 6 e 7mm.
- 2x adaptadores para os sistemas de travoes de Mercedes e Opel.
- 3x adaptadores de apoio para pinças de travões utilizáveis em espaços limitados.
- 3x adaptadores de apoio para pinças de travões utilizáveis em áreas de espaço limitado.
- 1x Fole com óleo lubrificante.

1pc: Grampo de rotação direita (com rosca à direita)

1pc: Grampo de rotação esquerda (com rosca à esquerda)

O: Disco 1: Disco 11: Disco para tipo S 12: Disco para BMW mini 5: Adaptador 3/8 2: Citroen XM, Xantia (F/R)

3: Alfa Romeo, Audi, Austin, BMW, Ford, Honda, Jaguar, Mercedes-Benz, Mitsubishi, Nissan, Rover, Toyota, VW.

4: Alfa Romeo 164 2.0, Ford, Mazda, Saab 9000, Subaru.

7: Audi 80, 90, V8 +100, Ford Sierra ABS+Scorpio ab 85, Honda Prelude Nissan Silvia 1.8 turbo, Rover 8000,

Saab 9000, Subaru L+Z, VW-Golf +Passat.

8: GM Motors. 9: GM Motors. O: GM Motors. M: Ford. N: Saab, Honda. Z: Renault. E: Cefiro, Maxima. G: Opel.

K: Citroen C5, K1, K2: Citroen, Renault. A: disco de dois pinos 1-3 / 16" para Renault R21, Laguna

B: Ford, Lincoln, Subaru.

C: Mini Austin. D: Citroen, Renault. F: Opel (disco trasero) P: Audi, BMW, Ford, Lancia, Proton, Renault, Rover, VW.

J: Alfa Romeo 155 1.8-2.0 164 TD(93) 164 3.0 V6(91) Audi, 80, 90, A3, A4, A6, A8 Citroen ZX 2 Ql 16V, Fiat Tipo TD 16V, Uno Turbo(85) Crama

TD, Ford Sierra(ABS bak), Granada (85), (Australia & NZ) Thunderbird Turbo, Honda CRX, 1.6l-16V (8-90), Accord 1800(84-85) 2.0i,

Prelude 16V(88), Legend V6, Jaguar XJ40series, Lancia Dedra 2.0 Ei Tur(93), Delta 1.6Gti, Nissan, Peugeot, Renault, Seat, Subaru,

Volvo V40& S40.

R: Ford (Australia & NZ) Telstar, Laser, Mazda 323 Gti, GTX(86-), 929(82-), RX7(81-), 626 16V(87-), 626 GT (86-), 929 V6(88-), Mitsubishi

Galant GL Si, Toyota Celica, Corolla GT, MR2.

S: Audi 100TQi (91), BMW 740i 8cy.l.(91), Lancia Delta 19 TD(95), Proton 416, Renault-most models, Renault Laguna 2.0 (94), Laguna 2.2 D(95), Safrane 2.0-2.2 TD V6, Rover 623 Si, Volkswagen

Golf Gti Mk 3&4, Passat VR6, Vento GT(92).

H6: BMW H7: BMW Pin Ø 3.0 Pin Ø5.5 100g Grasa.

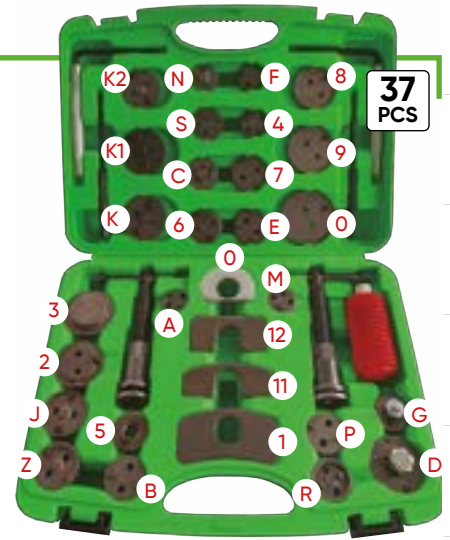

37  
PCS

## CONJUNTO DE RECOLHA DE EMBOLOS PARA TRAVÕES

53978

44,00€



- Kit usado para comprimir o pistão da pinça.

O: Placa

1: Placa

0: General Motors (Ø pistões 21/2 pol.)

2: Citroën XM, Xantia

3: Alfa Romeo, Audi, Austin, BMW, Ford, Honda, Jaguar, Mercedes-Benz, Mitsubishi, Nissan, Rover, Toyota, VW

4: Alfa Romeo 164 2.0, Ford, Mazda, Saab 9000, Subaru

5: Adaptador quadrado 3/8 pol.

6: Nissan Primera, VW Golf IV

7: Audi 80; 90; V8 + 100, 1985 Ford Sierra ABS + Scorpio, Honda Prelude, Nissan Silvia 1.8 turbo, Rover 8000, Saab 9000, Subaru L + Z, VW Golf + Passat

8: General Motors (pistões de 17/8 pol.)

9: General Motors (Ø pistões 21/8 pol.)

IV: VAG, Renault, Volvo com freio de estacionamento eletrônico

A: Renault

E: Nissan Maxima, Cefiro

F: Opel

J: Para Fiat Tipo TD 16V, Uno Turbo (85)

Crama TD, Honda CRX, Alfa Romeo 155 1.8-2.0, 164 TD (93), 164 3.0 V6 (91); Audi 80, 90

e V8, A3, A4, A6, A8 (pinça traseira); Citroen ZX 2.0l 16v; Fiat Tipo TD 16V, Uno Turbo

(85-), Crama TD; Ford Sierra (parte traseira com sistema de travagem antibloqueio

ABS), Granada (85-); Ford (Australia e Nova Zelândia) Thunderbird Turbo; Honda CRX,

1.6l-16V (88-90), Accord 1800 (84-85), 2.0i

(86-), Prelude 16V (88-), Legend V6; Jaguar

XJ 40 series Lancia Dedra. 2.0 Ei Tur (93),

Delta 1.6 Gti. (92), o. majE 16v (92), Thema.

2000 Turbo. Kappa 2.Q-2.4LS, 2.4TD; Nissan

280 ZX (82-84), 300 ZX Turbo (84-89), Blue-

bird 16V (89-), Silvia 1.8 Turbo (85-88) 100 NZ

2.0 (93), Primera 2.0 GT (94), 200 SX turbo

16 V, Maxima 2.0 GX-3.0 GX (95); Peugeot

306; Peugeot 309 Gtj 16S (91), 405. Srif Q. rj,

Gil (87-), 405 M.I 16V; Van Renault Master;

Rover 216 Gti 16V, 820 Si 2.0 (93), 825 SD

2,5 (93); Saab 9000 CS 2.0 (93), 9000 CSE

Turbo (93); Seat Toledo GT. 16V-GT 2.0 (93),

Ibiza 1.8 Gti 16V (95); Subaru série L e série

2; Volkswagen Passat 2.0 e 2.2 litros (84),

Golf Rallye (-89), Golf II Gti 16V (89-), Vento

GT (92), Transporter T4; Volvo S40 e V40

K: Citroën C5

K1: Citroën

K2: Citroën

M: Ford

N: Saab, Honda



23  
PCS

## CONJUNTO DE RECOLHA DE EMBOLOS DE TRAVÕES UNIVERSAL

52906

49,00€



12974



12975

REF.	DESCRIÇÃO	1	5	€
12974	Repuesto 2 pins	0,15	50	21,00€
12975	Repuesto 3 pins	0,17	50	23,00€

- Alfa Romeo 164 2.0, Ford, Mazda, Saab 9000, Subaru, Nissan Primera, VW, Audi, Ford Sierra ABS + Scorpio ab 85, Honda Prelude, Nissan Silvia 1.8 turbo, Rover 8000, Saab 9000, Ford, Opel, BMW, Lancia, Proton, Renault, Rover, Peugeot 307, 308 A3- Iveco Daily, Volkswagen Passat 2.0 TDI 09, Renault Laguna.

## REPOSICIONADOR DE FREIO

14142

101,50€

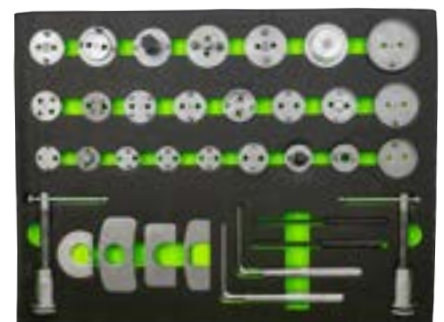
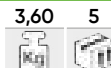

34  
PCS

- 24x adaptadores
- 4x placas de retenção
- 2x eixos de rosca
- 2x socos
- 2x llaves hexagonais



## ESTÔJO PARA REPARAÇÃO DE TRAVÕES

**52434** 3,05 5 80  
125,50€

- Contém:  
Chave para fêmea de travão.  
2 Alicates de mola de travão.  
Chave de fenda de impacto.  
Chave de cardan.  
Chave para desapertar.  
Ferramenta especial de travão.  
Escova de limpeza.  
Alicates de cabo de travão.  
Lima para cinta de travão.



### ALICATE PARA FREIO DE TAMBOR

**52625**  
9,00€

0,32 6 48



## TESTE DE FLUÍDO DE TRAVÕES

**51839** 0,05 10 100 2.400  
24,00€

- Funciona com pilhas 1xAAA LR03.  
- Com 4 níveis de qualidade medíveis de 0% a 4%.



## SANGRADOR DE TRAVÕES

**52191** 9,41 1 12  
198,00€

COMPRENDE TAMPAS REF. **52328**

- Pressão de trabalho: de 0 a 4 kg/cm².  
- Entrada e saída de 1/2".  
- Peso: 5Kg.  
- Adaptadores: 11 + 2 universais.  
- Aplic.: GM, Chrysler, Nissan.

330mm  
230mm  
230mm



TAMPAS PARA SANGRADOR DE TRAVÕES PARA VEÍCULOS GM, CHRYSLER, GM, NISSAN

**52328** 0,75 4 120  
80,00€

- 9 Adaptadores de aceite de travões: Universal nº1, nº2, nº3, nº4

## APALPA FOLGAS PARA PASTILHAS DE TRAVÕES

**52455** 0,26 10 20 864  
16,00€



COLOR	METRIC	SAE
Green	8-10-12mm	0.3150-0.4720"
Yellow	4-5-6mm	0.1575-0.2382"
Red	2-3mm	0.0787-0.1181"

## SEPARADOR DE EMBOLOS DE TRAVÕES

**52315** 0,88 5 430  
14,00€

- Abertura máxima 80mm.



## ALICATE PARA FREIO DE TAMBOR

**52625** 0,35 6 48  
9,00€

- Para remoção e instalação de molas de retorno em freios a tambor.



## ALICATE ESPECIAL TRAVÕES

**52389** 0,32 5 50 600  
29,00€

- Para separar os calços dos discos.  
- Para sistemas de travões em carros e motociclo.

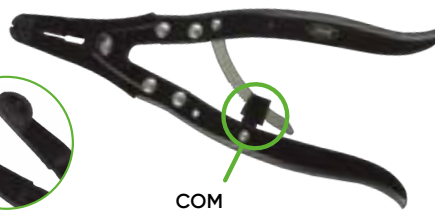

COM ANTIBLOQUEIO





FILTROS



ÓLEO



INJECCÃO



COMPRESSÃO



AQUECEDORES / EXTRACTORES



ESCAPE



DINAMOMÉTRICAS



MEDIÇÃO



DESMULTIPLICADOR DE FORÇA



EMBREGEM

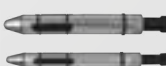

AR CONDICIONADO

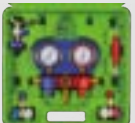

SISTEMA DE REFRIGERACIÓN



COMPRESSORES

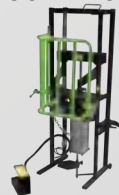

DIVERSOS



180

182

184

188

190

202

203

204

205

206

207

208

211

212



# UTILLAJE



**SERIE363**

# CONJUNTO DE CHAVES PARA FILTROS DE ÓLEO DE ALUMÍNIO, 19 PÇS

54068

3,5 2

211,50€



PEÇAS EM ALUMÍNIO

19 PCS

## DESMANCHA DISPONÍVEL

REF.	Nº DE PEÇAS	CARACTERÍSTICAS	Ø x FACES				€
15494	05101	Mazda, Mitsubishi	100,5mm x 15	5	10		12,50€
15495	0595	Nissan, Toyota	94,5mm x 15	5	10		12,50€
15496	0592	Nissan, Subaru	92mm x 15	5	10		11,50€
15497	0579	Toyota, Honda, Mitsubishi, Subaru, Mazda, Isuzu	79mm x 15	5	10		11,00€
15498	915	Volvo	87mm x 16	5	10		11,50€
15499	901L	Lexus	79,5mm x 14	5	10		11,00€
15500	901T	Toyota	70mm x 14	5	10		10,00€
15501	901-1	Toyota	63-64mm x 14	5	10		10,00€
15502	902	Ford, Mazda	66,5mm x 14	5	10		10,00€
15503	1284	Dodge Sprinter (2007-), Mercedes Benz E320 (2007-), Jeep Cherokee 3.0L V6 Common Rail (2007-)	84mm x 14	5	10		11,00€
15504	903B	Mercedes Benz	74mm x 14	5	10		10,00€
15505	24mm	BMW 5, BMW 7, BMW X5 V8 (N62) (2004-), Saturn (2008), Astra 1.8L ECOTEC, Chrysler 3.6L V6 (2011-), 200, 300, T/C Dodge Jeep	24mm x 14	5	10		4,00€
15506	27mm	Mercedes Benz Classe A	27mm x 6	5	10		4,00€
15507	30mm	Audi A2, Vw Polo, Lupo 1.4L/1.6L	30mm x 6	5	10		4,50€
15508	32,5 mm	Opel Astra G, Corsa B, Zafira, Audi, VW 1-36 mm, Opel Omega, Vectra B, Zafira (98-), BMW M43/60	32,5mm x 6	5	10		4,50€
15509	36mm	Opel Omega, Vectra B, Zafira (98-), BMW M43/60, Mercedes Benz Vito CDI, C, E, VW Lupo 1.2 TDI, MAN	36mm x 6	5	10		5,00€
15510	38mm	Opel Vectra 2.0D	38mm x 6	5	10		5,00€
15511	917	Universal	55-90mm	5	10		8,00€

901-1

0592



# JOGO DE EXTRACTORES PARA FILTROS ÓLEO

51332

4,19 5 60

98,00€



PEÇAS EM ALUMÍNIO

23 PCS

## DESMANCHA DISPONÍVEL

REF.	Nº DE PEÇAS	CARACTERÍSTICAS	Ø x FACES				€
11374	901	Toyota, Nissan, Fiat Daihatsu	65mm x 14	0,10	5	20	5,50€
11375	902	Toyota, Daihatsu	67mm x 14	0,08	5	20	6,50€
11376	903	VW, Mercedes, BMW, Opel, Audi	74mm x 14	0,09	5	20	5,50€
11377	903-1	GM/AC, Wix, Ford, Isuzu	75mm x 15	0,09	5	20	5,50€
11378	903-2	VW, Audi, Seat, BMW, Renault	74mm x 8	0,09	5	20	6,50€
11379	903-3	Audi, Rover, Chrysler	74mm x 15	0,11	5	20	6,00€
11380	903-4	Toyota, Lexus	73mm x 14	0,11	5	20	6,50€
11381	903-6	Schlepper, Baumashinen	75mm x 12	0,10	5	20	6,50€
11382	918	Rover, Chrysler, Audi	74mm x 15	0,11	5	20	6,00€
11383	904	Nissan, Ford	79mm x 15	0,10	5	20	6,00€
11384	905	GM, Chrysler	73mm x 15	0,12	5	20	6,00€
11385	905-1	BMW, Mercedes, Opel, Audi, VW	74mm x 14	0,10	5	20	5,50€
11386	906	Baumaschinen, Schlepper	84mm x 18	0,10	5	20	6,00€
11387	907	Mitsubishi, Toyota	89mm x 15	0,13	5	20	6,00€
11388	908	Nissan, Toyota	91mm x 15	0,14	5	20	6,00€
11389	915	Honda Accord, Mitsubishi, Isuzu	90mm x 15	0,16	5	20	6,00€
11390	910	Toyota, Alfa Romeo, Ford	95mm x 15	0,12	5	20	6,00€
11391	911	Fiat, Renault, Citroën	76mm x 12	0,09	5	20	6,50€
11392	911-1	Subaru, Toyota, Honda, Nissan	80mm x 15	0,09	5	20	6,00€
11393	914	Mazda, Toyota	101mm x 15	0,18	5	20	6,00€
11394	909	Isuzu, Nissan	92mm x 15	0,14	5	20	6,00€

11376

11385



REF.	CARACTERÍSTICAS				€
14992	Chave de 12 vias	0,10	-	-	8,50€
10955	Catraca 1/2"	0,14	-	1 50	11,00€

# CHAVE EXTRAÇÃO PARA FILTROS DE ÓLEO

**52311** 0,13 6 72 1.728  
19,00€



GRUPO VAG

42mm

**52312** 0,1 10 100 1.728  
9,00€



VW, OPEL, MERCEDES, BMW, AUDI

74mm x 14C

**52313** 0,2 6 72 216  
8,00€



VOLVO 540, 560, 570, 580

86mm x 16C

**52314** 0,28 5 50 600  
24,00€

Em caixa.



BMW VOLVO

87mm x 16C

**52809** 0,15 10 100 600  
7,80€



3/8" TOYOTA

64,5mm x 14C

**53441** 0,2 5 20  
9,80€



76mm x 14C

## EXTRACTOR PARA FILTRO ÓLEO FORD, CITROËN, PEUGEOT 2.0, 2.2 HDI, TDCI

**53008** 0,6 5 30 1.500  
15,50€



250mm



## EXTRACTOR DE FILTROS DE CAMINHÃO

**52518** 1,4 6 12 480  
88,00€

95-165mm



## EXTRACTOR PARA FILTRO DE ÓLEO

**52615** 3,05 5 80  
100,00€

- Chave de doble sentido ajustável.  
- Rango de aplicação: 60-80mm.

Audi, BMW, Mercedes, Opel, Renault, Volvo, Kia, Hyundai, Ford, VW, Skoda, Citroën, Mini

9 PCS

1/2" x1

UNIVERSAL

63-83mm

3/8" x8



- 27mm: Mercedes-Benz, Smart.  
- 32mm: GM, Opel/Vauxhall, Mercedes-Benz.  
- 36mm: Mercedes Diesel, BMW, Mini, Ford.



- 88,8mm: Hunday, Kia.



- 64,5mm: Toyota (Allion, Auris, Corolla, Prius, Voxy, etc.).  
- 64,5mm: Toyota, Lexus (6 Zyl).  
- 74,2mm: Audi, BMW, Ford, Toyota, Volkswagen, Porsche, Mercedes-Benz.



- 86,6mm: BMW 3+5+X, Volvo.



## EXTRACTOR FILTRO DE ÓLEO DE PATILHA PLANA / REDONDA

- Pode usarse com chave de 1/2" ou 3/8".

**51352** 0,34 5 40 1.280  
8,50€



57-118mm

**51934** 0,38 10 40 1.200  
10,00€



57-118mm

**51353** 0,57 5 40 960  
10,50€



72-136mm

**51923** 0,56 10 40 1.020  
11,00€



72-136mm

- Extrae todos os filtros de óleo 2-1/4" a 5" de diámetro.

- Extrae todos os filtros de óleo 2-1/2" a 4" de diámetro.

- Extrae todos os filtros de óleo 2-1/2" a 4" de diámetro.

- Extrae todos os filtros de óleo 2-1/2" a 4" de diámetro.



## CONJUNTO DE 5 VARAS PARA VERIFICAR O ÓLEO BENZ/AUDI

53206

0,4 5 50 300

33,50€



- Para verificar o fluido de transmissão de óleo nos motores audi 100:  
Na ponta (os primeiros 11mm) é a leitura do fluido a frio 20 0 c.

A segunda leitura é no mínimo a 800 c.

A terceira leitura é a 800 c. no máximo.

- Mantenha o veículo a nível para verificar o atf.  
- Vareta medidora para verificar o nível do óleo no motor. compatível com uma grande seleção de motores de 1988 a 2005 na gama mercedes.



VARETA PARA VERIFICAÇÃO DE ÓLEO - AUDI

13856

0,04 5 100

7,80€



- AUDI 100 motores.

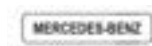

- Ano de fabrico: 1988-1997.

- Códigos do motor: 103,104,111,119,120,137,604,605,606,611,612,613,628,642,647,648.



- Código de transmissão: 716,5,722,7,722,8.



- Ano de fabrico: 1996-2005.

- Códigos do motor: 103,104,111,112,113,119,120,137,271,272,604,605,606,611,612,613,628,642,646,647,648.



- Código de transmissão: 722,6.

5  
PCS

## PINÇA EXTRACTORA DE FILTROS DE ÓLEO

51354

0,43 5 40 680

11,00€



80-120mm



## CHAVE DE FILTRO DE ÓLEO PARA VAG DSG 1/2" 24 MM

53670

0,25 10 40

29,50€



1/2"

- Conjunto de ferramentas para reparar e recondicionar os parafusos das rodas, bem como ancorá-lo à rosca fêmea do veículo; útil em rosca parcialmente danificadas.



## EXTRACTOR DE FILTROS DE CINTA

52269

0,15 10 50 800

7,00€



80-120mm

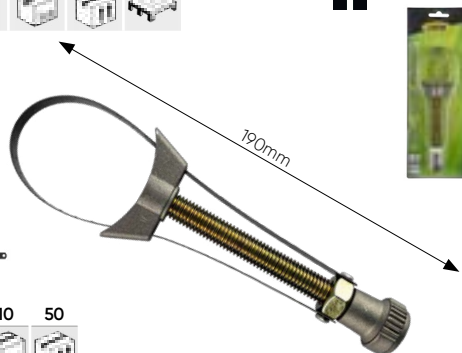

SUBSTITUIÇÃO 360mm

11106

0,02 10 50

3,00€



## EXTRACTOR DE FILTROS AJUSTÁVEL

52677

17,00€



Ø 65-105mm

52678

18,00€



Ø 110-155mm



REF.	SUBSTITUIÇÃO	PARA	0,03	10	100	€
11936	383mm	52677	0,03	10	100	4,00€
11937	540mm	52678	0,04	10	100	5,00€

## EXTRACTOR DE FILTROS DE CADEIA

52417

0,87 5 25 800

24,00€



Ø 160mm 300mm

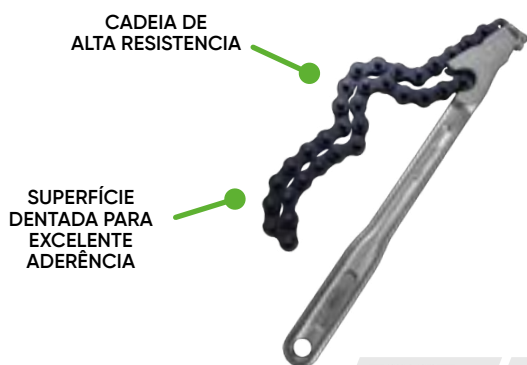

CADEIA DE ALTA RESISTENCIA

SUPERFÍCIE DENTADA PARA EXCELENTE ADERÊNCIA

## EXTRACTOR FILTROS DE CORRENTE

52416

0,34 5 50 1.050

10,50€



Ø 150mm 20mm 540mm



CORREIA DE POLÍMERO (ALTA RESISTÊNCIA)

SUPERFÍCIE DENTADA PARA EXCELENTE ADERÊNCIA

## EXTRACTOR DE FILTROS DE CADEIA

**52607** 0,86 6 24 432  
 49,00€ Ø 60 - 140mm

**52608** 0,99 6 24 576  
 42,50€ Ø 60 - 195mm

DOBLE CADEIA ARTICULADO

- O mais largo do mercado.

## BUJÃO DE CÁRTER DE PLÁSTICO

**53741** 0,05  
 12,00€   
 FORD/PSA

**13969** 0,01  
 15,50€   
 VAG

**53537** 0,05  
 12,80€   
 BMW

**53538** 0,10  
 12,80€   
 FORD

## JOGO DE CHAVES PARA BUJÃO DE CARTER

**53735** 1,70 12 504  
 41,00€

3/8" 23 PCS



### CONTÉM

	x2	5/16", 3/8"
	x7	7, 8, 10, 11, 12, 13, 14mm
	x1	10mm
	x1	10mm
	x7	8, 9, 10, 12, 13, 14, 17mm
	x1	T45
	x1	M16
	x1	200mm
	x2	75, 150mm

## MÓDULO DE CHAVES PARA BUJÃO DE CARTER

**15084** 2 10  
 46,50€   
 22 PCS

MÓDULO COM ACABAMENTO EM FIBRA DE CARBONO

240x135x32mm



### CONTÉM

	x2	5/16", 3/8"
	x7	7, 8, 10, 11, 12, 13, 14mm
	x1	10mm
	x1	10mm
	x1	T45
	x1	M16
	x1	200mm
	x7	8, 9, 10, 12, 13, 14, 17mm
	x1	150mm

## CHAVE PARA BUJÕES DE CARTER DE PLÁSTICO (VAG)

**53472** 0,1 10 100  
 12,00€

OEM: T10549

- Função: Para a extração de bujões de cárter de plástico.

- Aplicações:  
 Audi: A1, A3, A4, A5, A6, A7, Q3, Q5, Q7, TT, TTS.  
 Seat: Alhambra, Leon, Toledo.  
 Skoda: Octavia, Rapid, Superb, Yeti.  
 VW: Beetle, Caddy, CC, Golf, Jetta, Passat, Polo, Scirocco, Sharan, Tiguan, Touran.



## CHAVE QUADRADA PARA BUJÕES

**52617** 0,23 6 36 1.620  
 7,00€

8 - 10mm

- Para Citroën, Renault, Peugeot.



## CONJUNTO EXTRACTOR DE BUJÕES DE CÁRTER DE PLÁSTICO

**53473** 0,4 10 50 300  
 36,00€

5 PCS



FORD, VAG, PEUGEOT, CITROËN, BMW

x1 80x100mm

FORD  
 OEM 1830727

3/8"

x1 1/4"  
 3/8"

x1 1/4" 1.5mm  
 VAG  
 OEM 06L 103 801

x1 3/8" 11mm  
 PEUGEOT / CITROËN  
 OEM 9801444780  
 OEM 18711598

x1 10mm 1/4"

BMW  
 OEM 11137605018

## KIT DE REPARAÇÃO DE BUJÕES DE CARTER

51337

1,58 10 180

48,00€



- Bujões de SKS3.
- Machos de 1015.
- Anilhas de Cobre.

- Contém:  
M13x1,5P  
M15x1,5P  
M17x1,5P  
M20x1,5P

- Macho: 1 x medida.
- Bujões: 5 x medida.
- Anilhas: 10 x medida.



## DESMANCHA DISPONÍVEL

5 nozes + 5 arruelas\*

REF.	CARACTERÍSTICAS					€
51403	M13 x 1,5P	0,13	5	50	100	17,50€
51400	M15 x 1,5P	0,17	5	50	100	17,00€
51401	M17 x 1,5P	0,15	5	50	100	22,00€
51402	M20 x 1,5P	0,1	5	50	100	20,50€

\*Entregado em bolsas de 5 unidades.

5 nozes + 5 arruelas

REF.	CARACTERÍSTICAS					€
14930	M13 x 1,5P	-	10	100		9,50€
14931	M15 x 1,5P	-	10	100		8,00€
14932	M17 x 1,5P	-	10	100		9,50€
14933	M20 x 1,5P	-	10	100		9,50€

## KIT REPARADOR DE ROSCAS DE TAMPÃO CARTER

53235

0,3 10 40

9,50€



M13



53236

0,3 10 40

11,55€



M15



53237

0,3

12,50€

10

40

M17

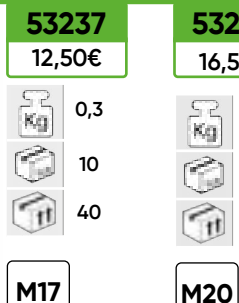

53238

0,4

16,50€

10

40

M20



## EXTRACTOR DE INJECTORES DIESEL PARA CITROËN, PEUGEOT

53069

2,44 5 150

98,00€



CITROËN  
PEUGEOT

- 1x ponte rolante.
- 3x suportes de ponte.
- 2x fuso extrator - Ø17mm, Ø25mm.
- 1x porca cilíndrica para fuso.
- 2x mangas de injectores de 25 mm e 29 mm.
- 1x chave hexagonal de segurança de 21 mm.



## JOGO EXTRAÇÃO DE INJECTORES

51494

3,63 5 20 125

107,00€



- Com martelo deslizante para motores CDI e motores Mercedes CDI Om 611, 612, 613 etc. para extrair os injectores entupidos e common-rail sem desmontar a culata.
- A construção robusta permite uma melhor extração dos injectores mais bloqueados.
- Material: aço S45C.
- Longitude total: 350mmL.
- Contém:  
Martelo: 1.75Kgs.  
Adaptador: M17 x 1,0  
Adaptador: M27 x 1,0



M12x1,75 /  
M8x1,5



M14x1,5 /  
M17x1,0



M14x1,5 / M27x1,0



1,75Kgs



HRC:  
Hardness  
30-35



M14x1,5 /  
M12x1,75



M14x1,5 /  
M8x1,5



M14x1,5



M14x1,5 / M8x1,5

## EXTRACTOR INJECTORES PARA MERCEDES-BENZ CDI

51499

146,00€



3,61 5 125



- Extractor de injectores para Mercedes CDI 4335.
- Este conjunto de sete peças foi especialmente desenhado para a eliminação dos injectores de stubbón.
- Mercedes Benz equipados com motores de veículos CDI.

## CHAVE DUPLA ABERTA PARA INJECTORES

52821

27,50€

0,24 6 96



17mm





## EXTRACTOR UNIVERSAL PARA INTERIORES/EXTERIORES

53250

4,8 2 4 90

71,00€



- Material: aço.
- Extração externa: de 40 a 80mm.
- Extração interna: de 50 a 150mm.

- Inclui:  
 Extrator de três garras exterior.  
 Triples garras int. para extração de rolamentos.  
 1 Extrator profundo.  
 1 conector de parafuso.



## JOGO DE EXTRAÇÃO DE INJECTORES

52858

21,20 1 32

298,00€



- Para remover os injectores diesel.
- Adequado para a maioria dos injectores diesel, muitos adaptadores incluídos.

- Componentes:

3 martelos diferentes:  
 1,6 kg - 160 mm de comprimento.  
 2,7 kg - 460 mm de comprimento.  
 5.1kg - 600 mm de comprimento.

Puxando a aderência com a abertura da forquilha:  
 13,7x18mm, comprimento 105mm.  
 12,7x19mm, comprimento 130mm.

1/2 "vasos de fenda 6pt, 100 mm de comprimento.  
 Tamanhos: 25, 27, 28, 29, 30.  
 Eixo extractor Injector M17x1,0.

Adaptador com rosca externa:  
 M27x1,0x1,0 e M25.

Adaptador com rosca interna:  
 M27x1,0 parafuso.



## EXTRACTOR DE INJECTORES PARA VAG

52622

73,50€

2,73  
 5  
 120



VW  
 AUDI

## EXTRACTOR DE INJECTORES PARA MERCEDES

52629

90,50€

1,22  
 50  
 440



MERCEDES

M16X1.5

- Material: Cromo molibdeno SD45C.
- Para motores VW / Audi DIESEL.
- Aplicações: 1.4 SDI, TDI, 1.9 D, SDI, TDI, TDI (PD), 2.0 TDI (PD) & (PD 4-VALVES), 2.5 TDI / TDI(PD), 2.8 TDI (PD), 2.7, 3.0 TDI (Common Rail), 4.2 TDI (Common Rail).

- Extrator de injectores para Mercedes C/E/S CLASS, VITO.
- Com conexão eléctrica.
- Este conjunto foi especialmente desenhado para a eliminação dos injectores.

## EXTRATOR DE BOMBA DE INJEÇÃO DIESEL BMW

53501

20,00€

0,55 10 20



- Segura as engrenagens durante a montagem da bomba de injeção.



- BMW: M47 / M47T2 / M47TU / M57 / M57TU.
- SERIES: E46 (318D-320D) (1988 - 2005) and E60, E61 (318TD-320TD-525D-530D-530-535) (2000 - 2006).
- OEM1 13 5 191 | 13 5 192 | 13 5 190 BMW.

## EXTRATOR DE TUBO DE INJEÇÃO DIESEL

53009

38,00€

0,5 4 20 560



14, 17, 19mm



3/8"



## EXTRACTOR DE ANILHAS DE INJECTORES

53522

19,20€

0,09 5 20 300



Ø 4,5 - 15mm



## 2PCS FERRAMENTA PARA RODAR VÁLVULAS

52850

6,50€

0,11 6 72



Ø 3,49-2,86mm  
 Ø 1,59-2,06mm

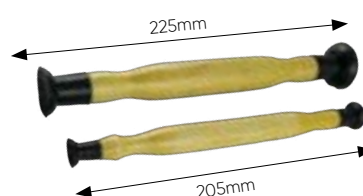

## MEDIDOR E COMPROVADOR DE RETORNO DE INJECTORES

51493

66,00€

0,96 5 120



Adequado para uso em  
BOSCH, SIEMENS, DENSO e  
DELPHI

- A finalidade deste kit é medir com rapidez e eficácia a quantidade de combustível que cada injetor retorna ao depósito, de modo que você saberá se algum injetor está estragado.

- Contém:  
Suporte para pendurar os 6 frascos para a medição do combustível.  
6 tubos de medição (para crack única condição).  
Tubos brancos.  
Caixa de armazenamento.

POTE + TAMPA + MANGUEIRA  
PARA 51493

12901

5,20€

0,03 10 60

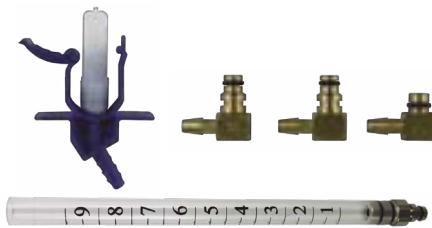

## KIT RECTIFICADOR DE INJECTORES

52813

71,00€

2,23 5 180



- Jogo de 17 rectificadores para limpar as sedes dos injectores.



x8 14x14, 15x19, 15.5x15.5,  
17x17, 17x17.5, 17x19,  
17x19.5, 17x20mm

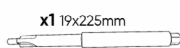

x1 19x225mm



x5 15.5x15.5, 17x17,  
17.5x20.5, 17x21mm

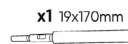

x1 19x170mm



x1 19x21.5mm

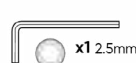

x1 2.5mm

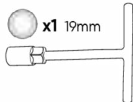

x1 19mm



17  
PCS

## KIT RECTIFICADOR DE INJECTORES

52273

44,00€

1,28 5 220



- Jogo de 7 rectificadores para limpar as sedes dos injectores, quando nos motores diesel se reacondicionam ou substituem os injectores



x3 15x19  
17x17 BMW / PSA / RENAULT / FORD  
17x19 MERCEDES CRD

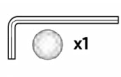

x1



x2 17x17mm MERCEDES-BENZ CDI  
17x21mm FIAT / IVECO



x1 12cm

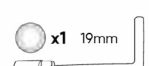

x1 19mm



8  
PCS

## SET DE CHAVES PARA BOMBA INJETORA

53330

32,50€

0,75 5 20 144



Cr-V 1/2" 1/4" 5  
PCS

- Bomba de injeção BOSCH.  
- TDI.  
- Common Rail.



## BOMBA INJECTOR DIESEL

52801

24,00€

0,13 5 50 1.500



- Durante a substituição da bomba de injeção, filtros ou outras partes, impede e retracção do combustível para o depósito.  
- Após a montagem de peças para substituir bomba permite bombear combustível para linha de injeção.



## KIT PARA O SISTEMA DE INJEÇÃO - LAMBDA

51491

141,50€

3,89 5 150



- 17x78mm (12PT): Renault.  
- 19x78mm (12PT): VW, Polo, Audi, Seat, Mazda.  
- 20x78mm (6PT): Deschis Japon.  
- 27x78mm (6PT): Deschis Japon.  
- 21x90mm (12PT): Seat, Audi, VW, Skoda, Alfa Romeo, Mitsubishi.  
- 22x78mm (12PT): Seat, Audi, VW, Skoda, Opel.  
- 22x110mm (12PT): Mercedes, Citroen, Peugeot, Ford, Nissan, Mazda, Mitsubishi, Seat, Audi, VW, etc.

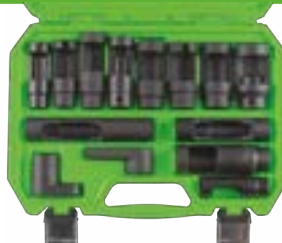

14  
PCS

## CHAVE PARA SONDA LAMBDA

52820

0,53

6

36

22mm

43,50€



CABEÇA ARTICULADA

52822

0,41

5

20

22mm

32,00€



CABEÇA ARTICULADA



- Chave hexagonal com janela, permite a extracção de sondas lambda localizadas em lugares de difícil acesso.

## KIT 7 PEÇAS PARA SISTEMA DE INJEÇÃO LAMBDA

51119

2,05

5

10

200

56,40€



1/2"

3/8"



- Contém chaves de:  
1/2" de 29x9 a 90mm de comprimento.  
1/2" de 7/8" a 50mm de comprimento.  
1/2" de 27x12 a 78mm de comprimento.  
3/8" de 7/8" x 6 a 90mm de comprimento.  
3/8" de 7/8" x 6 a 80mm de comprimento.  
3/8" de 7/8" a 30mm de comprimento.  
3/8" de 1" e 1-1/16" a 74mm de comprimento.

## KIT DE REPARO DE ROSCA INTERNA E EXTERNA

54003

1,2

10

88,50€



Tamanhos da rosca:

- M14x1,5
- M16x1,5
- M18x1,5
- M20x1,5
- M22x1,5
- M24x1,5
- M27x2,0
- M28x1,5



CrMo

9 PCS

## KIT REPARAÇÃO ROSCAS HELICÓIDAIS

51896

2,2

5

300

115 PCS

75,00€



- Contém por medida:  
Broca.  
Macho de roscar.  
Chave helicoidal.  
Punção de ruptura.  
Conjunto helicóide aço Inox.

- Conteúdo:  
25 x M5x0,8  
25 x M6x1  
25 x M8x1,25  
25 x M10x1,5  
10 x M12x1,75

51897

2,21

5

378

39 PCS

112,50€



- Contém por medida:  
Broca.  
Macho de roscar.  
Chave helicoidal.  
Punção de ruptura.  
Conjunto helicóide aço Inox.

- Conteúdo:  
9 x M12x1,75  
9 x M14x2  
9 x M16x 2,0

## KIT REPARAÇÃO ROSCAS HELICÓIDAIS

53041

0,67

10

1.000 - ESPECIAL VELA DE IGNIÇÃO.

33,50€



M14x1,25



51898

125,00€

1,81

4

252

M18x2,5

51899

123,00€

2,12

4

252

M20x2,5



- Contém por medida:  
Broca.  
Macho de roscar.  
Chave helicoidal.  
Punção de ruptura.  
Conjunto helicóides aço Inox.



## CONJUNTO FERR. CORTE 60 P. MACHOS E CAÇONETES. MÉTRICO E PULGADA

50793

2,35 5 185

84,50€



60  
PCS

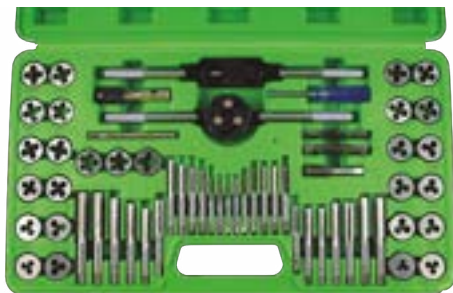

1 NPT macho (pol.): 1/8-27.  
1 NPT caçonete (pol.): 1/8-27.  
1 Porta Macho misto tip: M3 ~ M12 e 3/16 "a 1/2".  
1 Porta Macho misto tip: M3 ~ M6 ~ 6-32 e 4-40.  
1 Porta caçonetes misto: 25mm Ø.  
1 chave de fenda.  
1 jogo de galgas em polegadas para rosca.  
1 jogo de galgas métricas para rosca.  
10 Machos (métricos): M3x0,5, M4x0,7, M5x0,8, M6x1,0, M7x1,0, M8x1,25, M9x1,25, M10x1,0, M10x1,5, M12x1,75.

10 Machos UNC (polegadas): 4-40, 10-24 6-32, 8-32, 12-24, 1/4-20, 5/16-18, 3/8-16, 7/16-14, 1/2-13.  
6 caçonetes UNF (polegadas): 10-32, 1/4-28, 5/16-24, 3/8-24, 7/16-20, 1/2-20.  
10 Caçonetes (métricos): M3x0,5, M4x0,7, M5x0,8, M6x1,0, M7x1,0, M8x1,25, M9x1,25, M10x1,0, M10x1,5, M12x1,75.  
10 Caçonetes UNC (polegadas): 4-40, 10-24 6-32, 8-32, 12-24, 1/4-20, 5/16-18, 3/8-16, 7/16-14, 1/2-13.  
6 caçonetes UNF (polegadas): 10-32, 1/4-28, 5/16-24, 3/8-24, 7/16-20, 1/2-20.

## CONJUNTO FERR CORTE 58P. MACHOS E CAÇONETES RECOBERTAS DE TITÂNIO

50792

2,59 6 240

93,50€



58  
PCS



1 Macho e 1 caçonete tipo NPT: 1/8-27.  
1 Porta Macho: M4 ~ M12.  
1 Porta Machos tipo: M3 ~ M6.  
1 Porta caçonete: 25mm O / D.  
1 chave de fenda.  
1 jogo de galgas para rosca.

17 Machos: 2x0,4, 3x0,6, 3x0,5, 3,5x0,6, 4x0,75, 4x0,7, 5x0,8, 6x0,75, 6x1,0, 7x0,75, 7x1, 8x1,0, 8x1,25, 10x1,25, 10x1,5, 12x1,25, 12x1,75.

17 Caçonetes: 2x0,4, 3x0,6, 3x0,5, 3,5x0,6, 4x0,75, 4x0,7, 5x0,8, 6x0,75, 6x1,0, 7x0,75, 7x1, 8x1,0, 8x1,25, 10x1,25, 10x1,5, 12x1,25, 12x1,75.

## HELICÓIDAS DE SUBSTITUIÇÃO



REF.	CARACTERÍSTICAS	📏	📦	€/ x5
52016	M5x0,8	0,01	10	2,10 €
52017	M6x1,0	0,01	10	2,40 €
52018	M8x1,25	0,05	10	2,60 €
52019	M10x1,50	0,01	10	3,20 €
52021	M12x1,75	0,02	10	3,40 €

REF.	CARACTERÍSTICAS	📏	📦	€/ x5
52022	M14x2,0	0,01	10	4,50 €
52023	M16x2,0	0,01	10	6,60 €
52024	M18x2,5	0,05	10	10,60 €
52025	M20x2,5	0,01	10	13,00 €

## PROVADOR DE PRESSÃO E VÁCUO

53426

0,9 16

28,00€



VÁCUO  
VACUUM 0-28 inHg  
(0-70 cmHg)

PRESSÃO  
PRESSURE 0-0,7 kg/cm<sup>2</sup>  
(0-10 PSIG)



## MEDIDOR DE COMPRESSÃO OLEO

52754

1,31 5 160

48,50€



0-10 BAR  
0-140 PSI



- Útil para a verificação da pressão de óleo e diagnosticar problemas no sistema.

M10x1,0mm 1/8" DIN 2999  
M12x1,5mm 1/8" x 27 NPT  
M14x1,5mm 1/4" x 18 NPT  
M16x1,5mm 3/8" x 20 UNF  
M18x1,5mm 1/2" x 20 UNF

## COMPROVADOR DE PRESSÃO DO TURBO

53489

0,7 5 10

59,80€



2M  
-1-3bar



## MEDIDOR DE COMPRESSÃO DIESEL PARA CAMIÃO

52685

3,45 6 90

76,00€



0-70 BAR  
0-1000 PSI



- Kit completo para medir a compressão de veículos diesel.  
- Grande variedade de adaptadores para medir na maioria de veículos do mercado.  
- Sistema de enganche rápido para trabalhos em locais de difícil acesso.  
- Adaptador em ângulo e adaptador de roscas de M18 e M24.

- Dispõe de válvula de descarga e de sistema de retenção da leitura.

## MEDIDOR DE COMPRESSÃO GASOLINA

52488

0,7 5 20 425

24,50€



0-300 PSI  
0-21 kg/cm<sup>2</sup>



- Relógio regulado de dupla leitura (0-300psi e 0-2.000kpa) com válvula de decompressão.  
- O seu sistema de enganche rápido permite uma medição rápida e exacta em locais de difícil acesso; o adaptador cónico permite o uso na maioria de veículos do mercado.

## COMPROVADOR DE PRESSÃO PARA DIESEL E GASOLINA

53490

252,50€

5,5

2

40



- Alfa Romeo, BMW, Chrysler, Citroen, Daewoo, Fiat, Ford, Honda, Hyundai, Isuzu, Jeep, Kia, Lada, Lancia, Land Rover, LDV, Mazda, Mercedes, MG, Mitsubishi, Nissan, Peugeot, Renault, Rover, Saab, Ssangyong, Suzuki, Toyota, VAG, Vauxhall/Opel, Volvo.

DIESEL

Ø 10, 12, 14, 18MM



GASOLINA

Ø 10, 12, 14, 18MM



## MEDIDOR DE COMPRESSÃO DIESEL

52489

56,50€

2,15

6

72



- Ford, BMW, Mercedes Benz, VW, Citroën, Mitsubishi, Toyota, Peugeot, Renault, Volvo, Mazda.

0-1000 PSI  
0-70 kg/cm<sup>2</sup>

- Kit completo para medir a compressão de veículos diesel.  
- Grande variedade de adaptadores para medir na maioria de veículos do mercado.  
- Sistema de enganche rápido para trabalhos em locais de difícil acesso.  
- Adaptador em ângulo e adaptador de roscas de M18 e M24.  
- Dispõe de válvula de descarga e de sistema de retenção de leitura.



M18x1.5mm  
M24x2.0mm  
M24x1.5mm

M10x1.0x68mm  
M10x1.25x54mm  
M10x1.25x68mm  
M12x1.25x45mm

## KIT DE TEST PARA PRESSÃO DIESEL

51893

557,00€

0-1000 PSI  
0-70 kg/cm<sup>2</sup>

4,25  
3  
45



- Para diagnóstico de compressão para sistemas de injeção diesel.  
- Abrange até 70kg/cm<sup>2</sup> (1.000PSI).  
- Relógio de medição em borracha, com adaptadore em ângulo e prolongadores para trabalhos em locais de difícil acesso.  
- Apto para uso na maioria de motores diesel do mercado.  
- Com adaptadores de gama Alfa, BMW, Chrysler, Daewoo, Fiat, Ford, Hyundai, Isuzu, LandRover, LDV, Mazda, Mercedes, Mitsubishi, Nissan, Opel, PSA, Renault, Suzuki, Saab, Toyota, VAG, Opel, Volvo diesel.  
- Injector : M20, M22, M24 e Ford.

## KIT DE TEST PARA PRESSÃO GASOLINA

52599

215,00€

4,4

5



- O kit inclui todas as ferramentas necessárias para verificar o sistema de injeção de combustível na maioria dos carros de produção nacional e estrangeira.  
- Em no kit ficam incluídos um instrumento de medição de 3-1/2 polegadas, com leituras de exibição de 0-145 psi e 0-1 000 kPa, e outro instrumento de medição de 2-1/2 polegadas com dois modos de exibição das leituras.  
- Todos os adaptadores, medidores e conexões de mangueira estão equipados com um sistema de conexão rápida.



0-145 PSI  
0-1000 KPA  
3-1/2" 0-145 PSI

## KIT DE TEST PARA PRESSÃO GASOLINA

53997

47,50€

1,35

5



- Para detectar problemas no sistema de combustível.  
- O dispositivo é compatível com os sistemas de injeção Schrader.

0-10 bar  
0-140 PSI



1 Comprimento: 25,5cm  
Diâmetro externo: 1,2cm  
Diâmetro interno: 0,6cm

2 Comprimento: 29,5cm  
Diâmetro externo: 1,2cm  
Diâmetro interno: 0,6cm

3 Comprimento: 110cm



# JOGO PARA REPARA. ROSCAS DE VELAS DIESEL

52076

0,85 10

111,00€



1. Ferramenta instalação de casquilho - 2uds.
2. Pega para varilha - 1ud.
3. Casquilhos M8 x 1,0 - 5uds.
4. Casquilhos M10 x 1,0 - 5uds.
5. Casquilhos M10 x 1,25 - 5uds.
6. Casquilhos M12 x 1,25 - 5uds.
7. Bujão c/ extremidades s/rosca - 3uds.
8. Barra de instalação de casquilhos - 1ud.

- A. Macho de rosca M14 x 1,25 (para casquilhos de M12 x 1,25) - 1ud.
- B. Macho para abrir roscas M12 x 1,25 - 1ud.
- C. Macho de rosca M12 x 1,0 (para casquilhos de M10 x 1,25) - 1ud.
- D. Macho de abrir rosca M10 x 1,25 - 1ud.
- E. Inserção de corte M10 x 1,0 (para roscas de M8 x 1,0) - 1ud.
- F. Inserção de corte M8 x 1,0 - 1ud.

REF.	CARACTERISTICAS				€
11893	Helicóidais M8x1,0	0,01	5	7,00 €	
11894	Helicóidais M10x1,0	0,01	5	7,00 €	
11895	Helicóidais M10x1,25	0,05	5	8,65 €	
11896	Helicóidais M12x1,25	0,01	5	8,80 €	

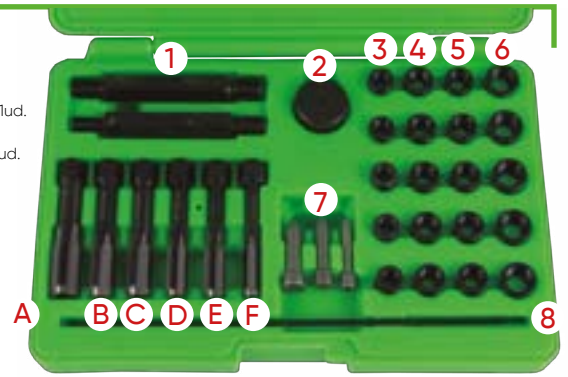

## KIT REPARADOR DE VELAS DE AQUECIMENTO

52305

2,79 10 180

93,50€



16  
PCS



- Extractor de velas de pré-aquecimento de 16 peças.
- Este kit é útil para a extração da vela partida ou presa.
- Universal e ideal para motores Mercedes-Benz CDI.
- Extraí as velas partidas ou presas M8 e M10.
- Inclui machos para rosca 1/4" M8 e broca de alta resistência de duplo tamanho M8 e M10.

## KIT SACAR VELAS DE ENCANDESCENTE

52815

96,50€

0,95  
5  
280



- Útil especialmente concebido para extrair pontas de electrodos de aquecimento em caso de ruptura durante o processo de extração.

## EXTRATOR DE CONEXAO DE AQUECEDOR

52816

0,27 6 36

25,50€



52817

0,28 6 36

23,50€

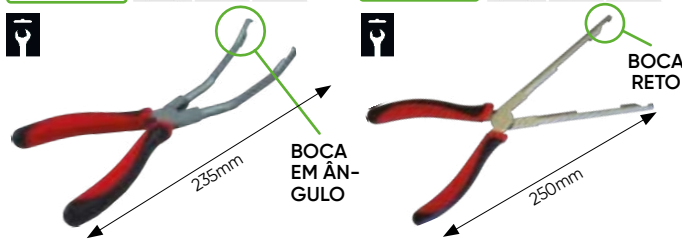

- Alicete para retirar as fichas no diesel aquecedores.
- Indicado para a remoção de rapidamente.
- Com conectores localizados em pontos de difícil acesso, os alicates permitem que você execute a operação sem risco de danos ao aquecedor ou outras partes de veículo.
- Empunhadura ergonômica emborrachada.

## KIT CHAVES TWIST DE 1/2" PARA EXTRAÇÃO DE FÊMEAS

52153

0,93 5 20 300

42,00€



17, 19, 21, 23, 27mm



## KIT CHAVES 3/8" PARA EXTRAÇÃO DE PORCAS

51998

0,69 5 20 360

31,50€



10  
PCS

9, 10, 11, 12, 13, 14, 15, 16, 17, 19mm

52962

0,72 5 20 1.500

44,00€



11  
PCS

6, 8, 10, 11, 12, 13, 14, 15, 16, 17, 19mm

3/8"

CR-MO

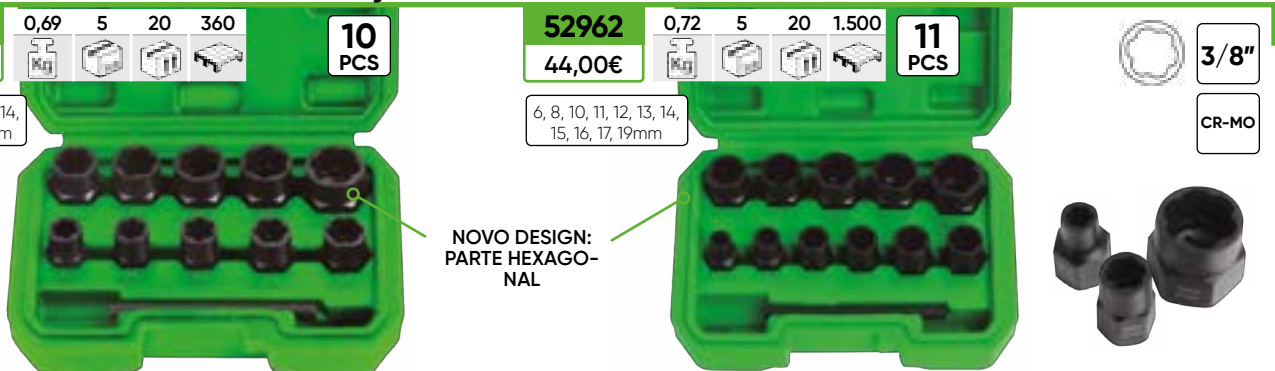

NOVO DESIGN: PARTE HEXAGONAL



## KIT DE PARAFUSO DA SEGURIDADE PARA BMW

53208

0,95 5 20

113,00€



41-60

BMW

22

PCS



- BMW Serie 1 F20/F21.
- BMW Serie 3 F30/F31.
- BMW Serie 4 F32/F34/F36.
- BMW Serie 5 F10/F11.
- BMW Serie 6 F12/F13.
- BMW Serie 7 F01/F02/F04.

## KIT DE PARAFUSO DA SEGURIDADE VW

53207

1,55 5 10 330

99,00€



VW

23

PCS

- |            |             |
|------------|-------------|
| b51 / 6pt  | b62 / 17pt  |
| b52 / 7pt  | abc0 / 10pt |
| b53 / 8pt  | abc1 / 11pt |
| b54 / 9pt  | abc2 / 13pt |
| b55 / 10pt | abc3 / 14pt |
| b56 / 11pt | abc4 / 15pt |
| b57 / 12pt | abc5 / 16pt |
| b58 / 13pt | abc6 / 17pt |
| b59 / 14pt | abc7 / 19pt |
| b60 / 15pt | abc8 / 20pt |
| b61 / 16pt | abc9 / 21pt |



## KIT DE PARAFUSO DA SEGURIDADE PARA BMW

52802

0,62 20

49,50€



- Útil para remover os parafusos.



10

PCS

BMW

- 30/13 PT
- 31/15 PT
- 32/16 PT
- 33/17 PT
- 34/18 PT
- 35/19PT
- 36/20 PT
- 37/21 PT
- 38/22 PT
- 40/23 PT

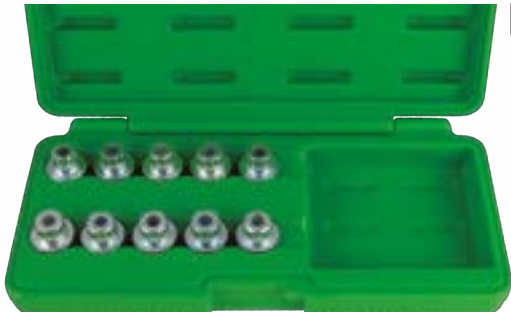

## KIT DE PARAFUSO DA SEGURIDADE PARA VAG

52823

0,94 5 20

99,00€



22

PCS

VAG

A, B, C, E, F, G, H, I, J, L, M, N, P, Q, R, S, T, V, W, X

- Especialmente concebido para remover os parafusos de segurança nas rodas veículos Volkswagen, cobrindo praticamente 100% da frota de veículos VW no mercado.



## KIT DE PARAFUSO DA SEGURIDADE PARA MERCEDES

53328

0,6 5 20

66,00€



MERCEDES

5A, 5C, 5D, 5E, 5F, 5G, 5N, 5L, 5P, 5X

12

PCS

- Classe A, B, C, GLK, CLC, CLS, CLK, E, SL, SLK, M, C300, C250, C350, E320, 204, 211, 212, R.



## KIT DE REPARAÇÃO DE ROSCA PARA PINOS DE RODA

53652

0,94 5 10 240

47,00€



- Conjunto de ferramentas para reparar e recondicionar os parafusos das rodas, bem como ancorá-lo à rosca fêmea do veículo; útil em roscas parcialmente danificadas.

- M12x1.25 - PSA
- M12x1.5 - MERCEDES BENZ / BMW
- M12x1.75 - VOLVO
- M14x1.5 - VAG



## EXTRACTOR DE BOBINA DE ENCENDIDO PARA VW

51495

53,50€

0,96

20

200

VW



- Para retirar e instalar as bobinas de encendido com tampa de motores de injeção de VW CYL 8 e 12 / 5 e 6 CYL, VW GOLF, BORA, 4 e 5 CYL. VW Passat, 6 CYL, Sharan VW, Touareg, Phaeton.  
- Para retirar e instalar as bobinas de encendido com etapa de potência de VW Polo, Golf 1.4, 1.6i, 1.4i CADDY, BORA 1.4, 1.6i Phaeton, Passat, Touran 1.6i, Transporter T4.

## DESMANCHA DISPONÍVEL



DISCO DE REPARO

REF.	CARACTERÍSTICAS	kg	PCS	€
14344	M12x1.25	0,49	20	11,00€
14345	M12x1.5	0,50	20	11,00€
14346	M14x1.5	0,46	20	11,00€



PARAFUSO DE REPARO

REF.	CARACTERÍSTICAS	kg	PCS	€
14340	M12x1.25 - PSA	0,05	20	10,50€
14341	M12x1.5 - MERCEDES / BMW	1,14	20	10,50€
14342	M12x1.75 - VOLVO	1,12	20	10,50€
14343	M14x1.5 - VAG	1,29	20	10,50€

## EXTRACTOR DE PARAFUSOS PARTIDOS

51496

0,09 12 72 2.000

5  
PCS

8,00€



Nº 1: 1/8" - 1/4" (M 3-6)  
Nº 2: 1/4" - 5/16" (M 6-8)  
Nº 3: 5/16" - 7/16" (M 8-11)  
Nº 4: 7/16" - 9/16" (M 11-14)  
Nº 5: 9/16" - 3/4" (M 14-18)



- Fabricados a partir de um tratamento térmico de aço cromo molibdênio.  
- Consegue uma rápida eliminação com a ajuda das hélices actuando como parafuso.

## KIT EXTRATOR DE MACHOS DE ROSCAR QUEBRADOS

53502

0,55 5 20

9  
PCS

33,50€



#2 M5  
#3 M6  
#4 M8  
#5 M10  
#6 M12  
#7 M14  
#8 M16  
#9 M20  
#10 M22



## JOGO DE CHAVES EXTRACTOR DE PER-NOS 1/2"

52833

0,82 5 20

1/2"

39,30€



6, 8, 10, 12mm



### DESMANCHA DISPONÍVEL

REF.	DESCRIÇÃO				€
14211	6mm	0,10	20	100	11,00€
14212	8mm	0,10	20	100	12,00€
14213	10mm	0,20	20	100	12,00€
14214	12mm	0,20	20	100	14,00€



## JOGO DO BOJUDO DA TUBOS

52700

0,93 6 12 528

3/16, 1/4, 5/16, 3/8, 1/2

20,50€

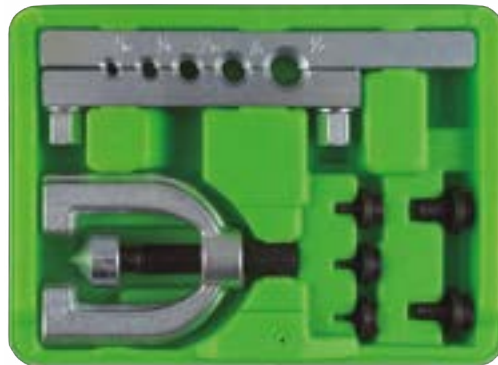

## CHAVE DE VELA ARTICULADAS

52691

0,79 24 480

53,50€



3/8"



82mm

COM  
FIXAÇÃO  
MECÂNICA



8, 9, 10, 12,  
14, 16mm

## CHAVE DE VELA MAGNÉTICA

52317

0,39 12 48 2.880

19,00€



Ø16mm

250mm

3/8"

52316

0,29 12 48 2.880

18,00€



Ø14mm



## CHAVE DE VELAS HEX.

10054

2,50€

0,09

25

100

16mm

16mm

16mm

16mm

16mm

16mm

16mm

16mm

16mm

16mm

16mm

10055

3,00€

0,14

25

100

21mm

21mm

21mm

21mm

21mm

21mm

21mm

21mm

21mm

21mm

21mm



1/2"

1/2"

1/2"

1/2"

1/2"

1/2"

1/2"

1/2"

1/2"

1/2"

1/2"

1/2"

1/2"

1/2"

1/2"

1/2"

BORRACHA  
DENTRO

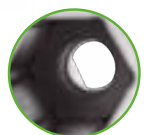



## ALAVANCA ARTICULADA PARA AFROUXAR POLIAS

**52961**  
82,50€

2,38 8 192

1/2"

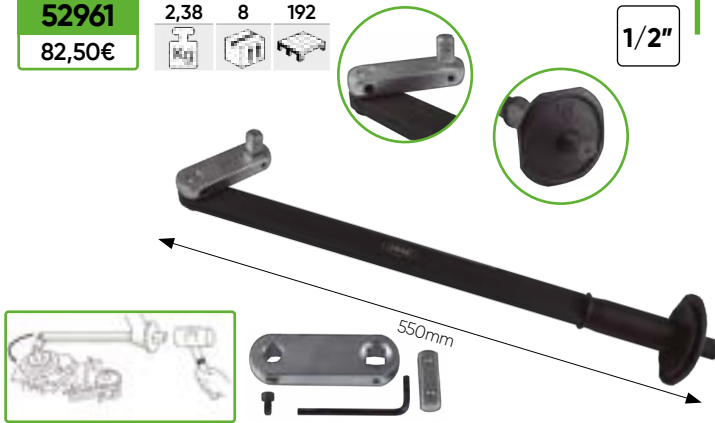

## ALAVANCA PARA AFROUXAR POLIAS

**52690**  
39,00€

1,54 10 280

3/8"

1/2"

- Alavanca de 230 mm com acionamento de 1/2".
- Alavanca de 585 mm com acionamento de 3/8".
- 3 chaves de 13,14,15 mm e 3/8" quadradas.
- 4 soquetes hexagonais de 3/8" quadrado e 13,15,16,18mm.

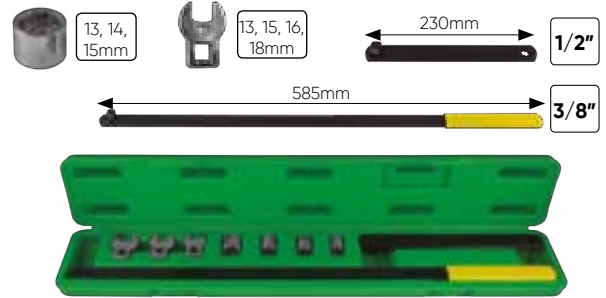

## JOGO DE CHAVES CURVADAS PARA EXTRAÇÃO DE CORREIAS 12 FACES

**52832**  
65,00€

1,35 5 160

12, 13, 14, 15, 16, 17, 18, 19mm



CABEÇA INTERCAMBIÁVEL



## KIT DE EXTRAÇÃO DE POLIAS DE 30 PEÇAS

**52293**  
89,00€

3,11 5 130

30 PCS



- 1/2" T50 c/33 dentes 19mmX33T - 110mmL.
- 1/2" M10 c/33 dentes 19mmX33T - 110mmL.
- H15x33 dentes 15mmx33T - 30mmL.
- H22x33 dentes 22mmx33T - 30mmL.
- H22 - 30mmL.
- H17x4 Pins especial H17x4Pins - 30mmL.
- 1/2"Dr. xH10 Bit adaptador.
- H8xH10 Punta 75mmL.
- H10xH10 Punta 75mmL.
- M8xH10 Punta 75mmL.
- M10xH10 Punta 75mmL.
- T40 xH10 Punta 75mmL.
- T50xH10 Punta 75mmL.
- M10xH12 Punta 64mmL.
- Especial H22xH28 - 30mmL.
- Especial H19xH28 - 30mmL.
- 1/2"Dr.xM10 punta M10 - 140mmL.
- 3/8"Dr.xM10 c/31 dentes.
- 14mmx31T - 85mmL.
- Especial H21xH28 - 30mmL.
- Especial H17 - 35mmL.
- Especial H38x3 Pins-20mmL.
- Especial 15mmx33T - 30mmL.
- H10xFH10 x68L 68mmL.
- T50xH12 Bit 64mmL.
- Especial H17xH21-30mmL.
- Especial H15xH28 - 30mmL.
- 3/8"Adaptador x10mm.
- 1/2"Dr.xT50 punta T50 140mmL.
- 1/2"Dr.xT50 punta T50 200mmL.
- 1/2"Dr.xM10 punta T50 200mmL.

## KIT DE EXTRAÇÃO DE POLIAS DE 18 PEÇAS

**51259**  
53,50€

2,10 5 180

18 PCS

- 3 x Chaves combinadas: T50x113mm, M10x113mm, M10x90mm.
  - 1 x Chave dentada: M10x140mm.
  - 2 x Adaptadores hexag. 19 e 22mm.
  - 3 x Chaves hexagonais: 22x28mm, 19x28mm, 21x28mm.
  - 1 x Adaptador Hex. 1/2" x 10mm.
  - 1 Punta M10x12x64L.
  - 6 x Pontas 10mm (varilha hexagonalis) x 75mm.
- Medidas: T40, T50, M8, M10, H8, H10.



## DESMANCHA DISPONÍVEL

**10494** 6,50€  
CHAVE D'EXTENSÃO  
14cm

**10495** 3,00€  
PONTA H10

**10496** 3,00€  
PONTA H8

**10497** 3,00€  
PONTA M10

**10498** 3,00€  
PONTA M8

**10499** 3,00€  
PONTA T40

**10500** 3,00€  
PONTA T50

**10502** 3,50€  
PONTA M10 TORX

**10501** 8,10€  
CHAVE PONTA  
XZN M10 90mm

**10485** 8,10€  
CHAVE PONTA  
XZN M10 110mm

**10486** 8,00€  
CHAVE PONTA  
TORX T50 110mm



## EXTRACTOR DE FÊMEAS

51368

0,41 10 50 1.000

18,00€



∅  
↑ 42mm  
↓ 33mm



## EXTRACTOR DE PERNOS

51414

0,59 5 40 1.440

11,00€



∅  
↑ 20mm  
↓ 15mm



## KIT DE BLOQUEIO CITROËN/PEUGEOT 1.0/1.2 VTI

53875

1,85 4

125,00€



## EXTRACTOR DE FÊMEAS AXIAIS

51369

0,55 6 36

22,50€



∅  
↑ 42mm  
↓ 35mm



## EXTRACTOR DE POLIAS ARMÔNICO

52624

1,26 5 360

25,50€



- Para a extração de polias e caixas de cambio.
- Material: acero al carbono.
- Diám. 35-85mm.
- Rosca central con parafuso flotante e extraíble.

- Contém:  
2 x parafuso 5/16" de 4".  
2 x parafuso 1/4" de 3".  
3 x parafuso 5/16" de 2".  
3 x parafuso 1/4" de 2".  
1 x 5" parafuso de pressão de ALU.  
1 x punta giratoria 3/4".



## EXTRACTOR DE POLIAS ENCRAVADAS

51500

1,55 5 10 640

28,00€



40-168mm

- Apto para o uso em cambotas, alternadores, unidades de A/C e bombas de água.
- Os braços de perfil baixo permitem um fácil acesso a zonas difíceis do motor.
- Desenhado para a extração da cambota encravada, amassada e de polias auxiliares.
- Rang: 40-160mm.



## EXTRACTOR DE POLIAS UNIVERSAL

53664

0,80 10

32,50€



- Uso universal.
- Opção de multiposição para atender à maioria das polias.
- Ideal para trabalhar em áreas estreitas, economizando tempo de trabalho.

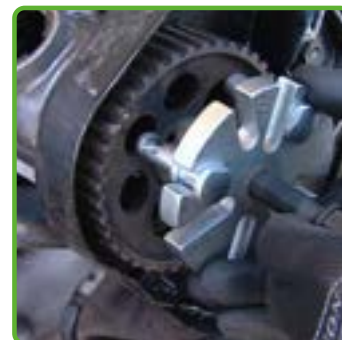

## ÚTIL DE EMBRAIAGEM ESPECIAL FIAT

52190

0,39 10 1.000

8,00€



220x110mm



- Facilita o acesso à carilha da forquilha para a sua extração e posterior substituição do disco.
- Rosca: 1,5cm de compr. x 0,5cm diam.
- Especificações:  
Útil para desmontar forquilha em embreagens de Fiat Ducato



## GANCHOS PARA EXTRAIR JUNTAS

53053

0,21 10 50 1.000

10,00€



1x15.5cm / 1x16.5cm / 1x12cm



## KIT PARA EXTRAÇÃO DE AIRBAGS

51501

43,50€



- Pontas 0,5 PC 1/4" x 87mm (L):  
2x Torx: T25 (para BMW), T30 (para Audi, Opel, Renault, VW).  
2x Torx (inviolable): T25H (Para BMW), T30H (Para AUDI), BMW, Mercedes, Opel).  
1x Hex: 5 mm (Para AUDI).

- 0,7 PC Ferramenta extração:  
1x para Airbag conductor. 1999-04 nuevo estilo de carroçeria de VW Passat, JETTA, GOLF.  
2x Para VW Passat B5, POLO, LUPO; AUDI A4, A6, Skoda Superb.  
2x Para VW GOLF 4, New Beetle, SEAT, SKODA FABIA, AB Oktavia BJ.99.  
1x Para VW GOLF 4 (BJ, 1998-2004), VW PASSAT BJ.1997 AB, AB BORA BJ.1999.  
1x Para U.A VW modelle: AB PASSAT BJ.2000.

12  
PCS

## PALANCA PARA BRAÇOS DE SUSPENÇÃO

51902

99,00€



- Comprimento: 118cm.  
- Diâm. Tubo: 3,5cm.  
- Distância de anclajes: 50, 45, 40, 35, 30 cm.  
- Anclaje de 15x13cm.



REPOSIÇÃO ÂNCORA  
DE FIXAÇÃO PARA  
REF. 51902

10953

12,50€

0,83 1



## KIT DE FERRAMENTAS PARA REMOÇÃO DE BRAÇOS DE DIREÇÃO

52639

117,50€



Ø 30-35mm  
Ø 35-40mm  
Ø 40-45mm



## ALINHADOR DE DIREÇÃO

51991

48,00€

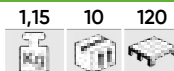

- Comprimento total aberto: 1950mm.  
- Comprimento total fechado: 1100mm.  
- Medida do parafuso: M6x15mm.  
- Tubo exterior de 20x20 de alumínio.  
- Tubo interior de 16x16 de ferro zincado.

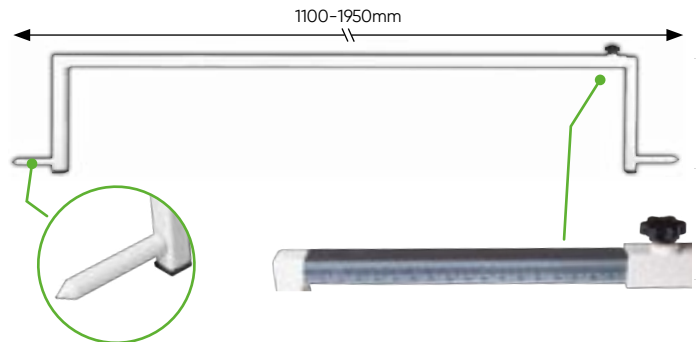

## EXTRACTOR PARA BRAZO DIREÇÃO

52640

46,50€



Ø 28-35mm

52641

49,00€



Ø 35-45mm



## EXTRACTOR PARA BRAÇO DE DIREÇÃO

52874

68,50€



Ø 9-20mm

52875

72,50€



Ø 14-23mm

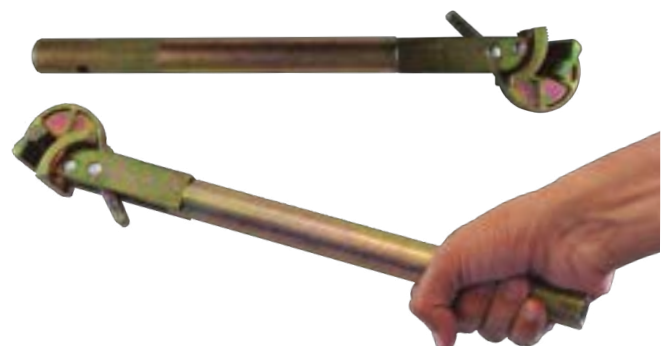

## EXTRATOR DE RÓTULAS HIDRÁULICO

**53384**  
145,00€



- Visão geral: 100mm.  
- Largura: 35mm.

**10kg**



FUSO HIDRÁULICO

**15253**  
57,00€

## JOGO DE 5 EXTRACTORES DE RÓTULA

**51123**  
88,50€

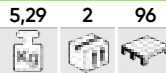

- Jogo de extractores versáteis.  
- Permite a fácil extração dos tipos mais populares de articulações de rótulas e demais.  
- O tipo de separador de prensa de junta, permite o retiro da junta de rótula sem estragos aos carregadores e a outras peças que outro tipo de extractores podem causar.

## JOGO DE EXTRACTORES DE RÓTULAS

**51490**  
32,00€

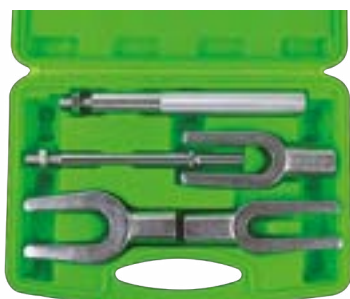

- Forquilhas feitas de aço cromo vanádio reforçado de alta resistência.  
- Ambos cabos são intercambiáveis.  
- 1 cabo desenhado para utilizarse com um martelo pneumático.

- Conteúdo:  
1 cabo para usar com um martelo.  
3 forquilhas: 11/16, 15/16" e 1-1/8".

## JOGO PARA TESTE DE EIXOS

**52541**  
43,50€



- Jogo para detectar deficiências em rolamentos, sinoblocos silenciosos, rolamentos de rodas, articulações axiais, rolamentos, estabilizadores, etc.

## EXTRATOR UNIVERSAL DE BOLA

**52642**  
30,50€

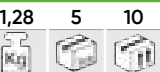

- Abertura Max: 60mm.  
- Abertura Min: 20mm

17 - 22mm

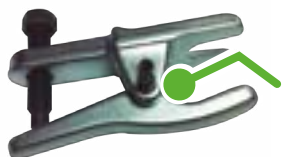

2 MEDIDAS AJUSTÁVEL

## EXTRATOR DE RÓTULAS

**52699**  
18,00€



- Abertura: 15-50mm.

Ø 18-22mm



## JOGO DE EXTRACTORES EM GUILHOTINA

**51125**  
81,50€



Capacidade das guilhotinas:

- Set Polegada:  
1/4" - 3 1/2", com 30mm e 50mm.  
Parafuso de 3/8" de 9,5x125 - 24 UNF.  
Cabeça de 3/8" x 16 UNC.

- Set 2 Polegadas:  
1/4" - 3 1/2", com 50x75mm.  
Parafuso de 1/2" de 12,7x135 - 20 UNF.  
Cabeça de 3/8" x 16 UNC.



## EXTRATOR DE GUILHOTINA

**52626**  
39,50€



75 - 105mm

**52627**  
82,50€



105 - 150mm

- Para extração dos rolamentos em autos e comerciais ligeros.  
- Extrae as caixas de cambio, polias e volantes.



## CHAVE PONTA XZN ESP. VAG

**12029**  
4,50€



INVIOLÁVEL  
M16X58MM



**12030**  
6,50€



INVIOLÁVEL  
M16X100MM



CrV

1/2"





## CONJUNTO UNIVERSAL DE EXTRATORES COM 2/3 CAPTURAS

**53701**

173,00€

8,45

1

44

13  
PCS

- Faixa de trabalho 2 pernas: 45-120mm.
- Faixa de trabalho 3 pernas: 50-130mm.
- Profundidade da faixa 100, 200, 250 mm.

- Completude:
- Guia central de 3 pernas.
- Guia central de 3 pernas.
- Pino: 165mm.
- Pernas longas com alças: 250mm.
- Pernas médias com alças: 200mm.
- Pernas curtas com alças: 100mm.



**14611** 0,11  
PONTA GARRA PARA REF. 53701 12,00€

**14612** 0,18  
PARAFUSO PARA REF. 53701 11,00€

**14613** 0,29  
PARAFUSO PARA REF. 53701 13,50€

## KIT DE EXTRATORES DE ROLAMENTOS COM 3 JOGOS DE GARRAS

**51122**

154,50€

4,5

5

120

- Contém:
- Guia Central.
- Parafuso.
- Garras para agarre curto.
- Garras para agarre médio.
- Garras para agarre comprido.

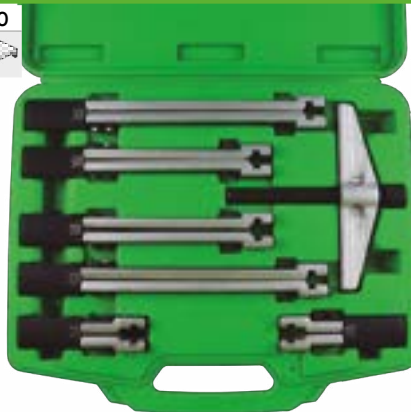

**11492** 0,24  
36,50€



**11493** 0,56  
39,00€



**11494** 0,69  
42,30€



PONTA GARRA PARA REF. 51122

**13679** 0,1 5 50  
10,50€

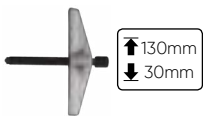

## JOGO DE EXTRAÇÃO DE ROLAMENTOS

**51124**

99,00€

3,29

5

120

- Contém:
- Extractor Universal (38,5mm).
- Adaptador de 3/8" a 1/2" (10-14mm).
- Adaptador de 9/16" a 11/16" (15-19mm).
- Adaptador de 5/8" a 1" (18-25mm).
- Adaptador de 1" a 1 1/4" (25-32mm).



## KIT DE EXTRATORES DE ROLAMENTOS COM ESFERAS FALSAS

**53062**

99,00€

2,41

5

180

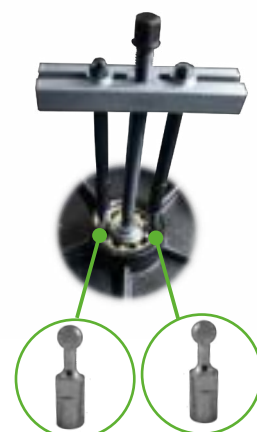
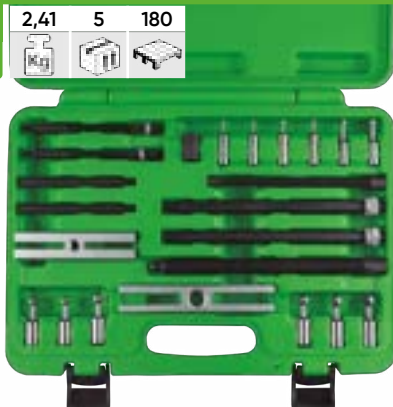

5, 6, 8, 9,  
11, 12, 5mm

## EXTRACTOR DE 2 GARRAS

## EXPOSITOR DE EXTRACTORES

**52727**  
30,00€

0,2 5 10 1.152

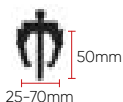

**52728**  
84,50€

1,23 5 10 500

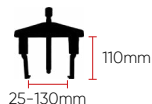

**53146**  
30,50€

0,7 5 10 200



- Extractores não incluídos.

**52729**  
144,50€

3,4 3 240

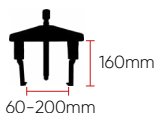

**52730**  
299,50€

8,64 2 72

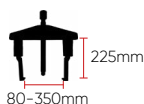

## EXTRACTOR DE 3 GARRAS

**52731**  
43,50€

1,08  
4  
24  
576

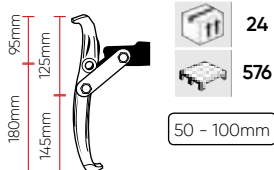

**52732**  
74,50€

2,53  
4  
12  
70 - 150mm

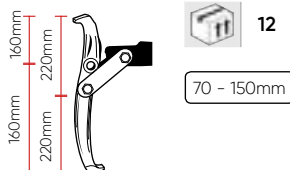

**52733**  
147,50€

5,19  
4  
72  
95 - 200mm

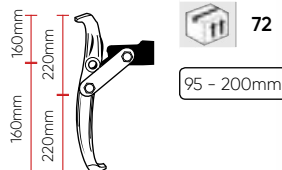

## EXTRACTOR DE 3 GARRAS CONVERTÍVEL EM 2 REVERSÍVEL

**52010**  
53,00€

0,48 4 40 360

- Medida da Garra: 90mm.
- Medida do pasador: 124mm.
- Unha do agarre: 12mm.
- Comprimento de cruzeta: 66mm.
- Profundidade: 75mm.



**52296**  
106,50€

1,57 4 8 120

- Medida de garra: 132mm.
- Medida do pasador: 217mm.
- Unha du garra: 14mm.
- Comprimento de cruzeta: 95mm.
- Profundidade: 110mm.



**52298**  
154,50€

2,65 6 396

- Medida de la garra: corta 134mm, larga 207mm.
- Medida do pasador: 218mm.
- Unha du garra: corta 13mm, larga 15mm.
- Comprimento de cruzeta: 95mm.
- Profundidade: 110 - 180mm.

GARRA CURTA E LONGA



**52297**  
149,00€

3,33 6 48

- Medida da garra: 210mm.
- Medida do pasador: 313mm.
- Unha du garra: 15mm.
- Comprimento de cruzeta: 152mm.
- Profundidade: 180mm.



## KIT DE 52 PEÇAS PARA EXTRAÇÃO DE EQUIPAMENTOS DE ÁUDIO

**53388**  
90,00€

**52**  
PCS

1,5  
5  
120



## KIT DE ACESSÓRIOS PARA EXTRAER EQUIPOS DE ÁUDIO

**51126**  
12,00€

0,2 10 100 1.320

- Blaupunkt, Peugeot, Clarion, Skoda, Alpine, BMW, Opel, Audi, Grundig VDO, JVC, Pioneer, Volkswagen, Mercedes, Porsche, Renault, Becker.



- Blaupunkt, Clarion, Skoda, BMW, Audi, Grundig, JVC, Pioneer, Volkswagen, Mercedes, Opel Doppel-Kugel-Inbus, Porsche, Becker, Kenwood, Sony, Panasonic, Fiat Brava, Ford.



## KIT DE 23 EXTRACTORES DE TERMINAIS

53393

1,60 5 110

118,00€



23  
PCS



- BMW, Audi, Volkswagen, Mercedes, Opel, Porsche, Jaguar, Saab, Seat, Ford, Skoda, Renault, Citroën, Chrysler, Fiat, Honda, Mazda, Mitsubishi, Toyota.

## KIT DE 19 EXTRACTORES DE TERMINAIS

53391

0,55 10

74,50€



A, B, C, D, E, F, G, H, I, J, K, L, A1, B2, C3, D4, E5, F6, G7

19  
PCS



## EXTRACTOR DE CASQUILHOS FRONTAIS PARA VAG

52432

1,32 5 300

35,00€



- Útil para VW POLO modelo 2002.  
- Facilita a troca dos casquilhos de borracha do eixo frontal.

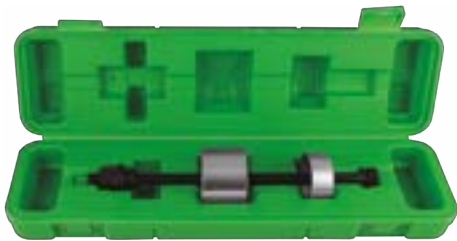

## EXTRACTOR DE CASQUILHOS PARA VAG

52270

3,18 4 96

99,50€



- Contém:  
Extensão de eixo.  
Porca de aperto de M10 x 1,25.  
Cabeça adaptadora de aço carbônica.  
Separador.  
Peça de pressão.  
Mandril centrado em aleação de alumínio.



## KIT CHAVES COM DENTES EXTERIORES

52834

3,73 5 1.500

186,50€



- Kit para a extração de porcas com fenda em veículos industriais.

11  
PCS

1/2"

CR-MO

mm  
22x3.3  
26x3.8  
30x4.3  
33x4.0  
37x4.8  
44x5.3  
50x5.8  
56x5.8  
63x6.3  
69x6.8  
75x6.8



## KIT CHAVES COM DENTES INTERIORES

52835

5,2 3 1.500

272,00€



- Kit para a extração de porcas com fenda em veículos industriais.

10  
PCS

1/2"

mm  
26x5.3  
1.2x6.25  
34.2x6.3  
38.2x6.65  
42.2x7.3  
50.1x8.25  
58.2x9.8  
74.6x11.9  
82.2x13.25  
87.7x13





# FERRAMENTA UNIVERSAL DE REMOÇÃO INSTALAÇÃO DE ROLAMENTAS E CASQUILHOS

52494

226,50€

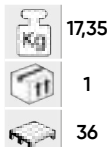

- Útil para instalar e desinstalar casquilhos e rolamentos de suspensão.
- Peças de duplo tamanho e varilhas de rosca de diferentes métricos.
- Medidas: M10, M12, M14, M16, M18.

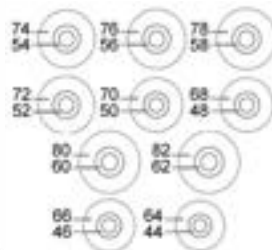

12926 M10  
21,50€

12929 M16  
23,00€

12927 M12  
21,50€

12930 M18  
23,50€

12928 M14  
22,00€

## KIT DE MONTAGEM PARA ROLAMENTOS

53058

177,00€



220mm Ø 12mm

Ø  
18, 19, 20, 21, 22, 23, 24,  
25, 26, 27, 28, 29, 30, 31,  
32, 33, 34, 35, 36, 37,  
38, 39, 40, 41, 42, 43,  
44, 45, 46, 47, 48, 49,  
50, 51, 52, 53, 54, 55,  
56, 57, 58, 59, 60, 61, 62,  
63, 64, 65, 74mm

## JOGO DE EXTRAÇÃO E INSTALAÇÃO DE ROLAMENTOS

53056

126,50€

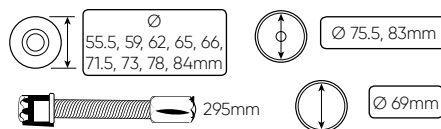
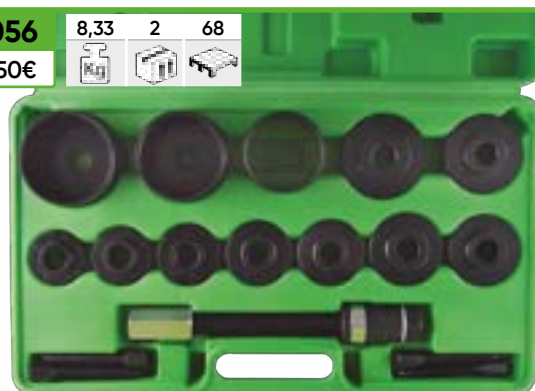
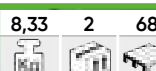

## JOGO PARA INSTALAÇÃO DE ROLAMENTOS

51349

35,00€



42 - 38mm  
40 - 35mm  
36 - 32mm  
30 - 28mm  
24 - 22mm  
27 - 25mm  
18 - 16mm  
20 - 18mm  
22 - 20mm  
12 - 10mm  
14 - 12mm  
16 - 14mm  
17 - 15mm



- Adaptadores de manutenção para porcas.
- Apto para todo tipo de eixo e rolamento.
- Medidas: de 10mm a 42mm.

## JOGO DE INSTALAÇÃO DE ROLAMENTOS Y FREIOS INTERIORES

53059

47,00€



Ø  
39,5, 44,5, 50, 59, 63,  
65, 72, 76, 81mm

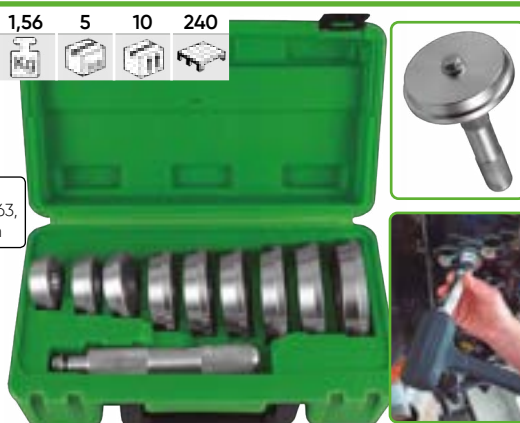

## JOGO PARA EXTRAÇÃO DE ROLAMENTOS

52551

150,50€



- Parafuso: 27mm
- Porca: 32mm
- Cilindros: 76, 82, 92, 101mm
- Parafuso reforçado para uso com ferramentas de impacto.
- Eje de aço fosfato é projetado para evitar a corrosão.



Número	955-08	955-11	955-07	955-12	955-13	955-14	955-09	955-15	955-06	955-17	955-18	955-19	955-16
Diâmetro (mm)	55.7	63.3	67.8	70.7	71.9	71.7	72.8	73.4	74.7	77.4	81.4	83.3	88.4

## KIT DE EXTRAÇÃO DE BRAÇO LIMPA VIDROS

**53463** 1,65 10 180  
**93,50€**

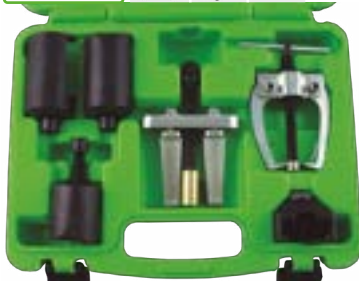

**VW:** Polo, Lupo, Touareg, Porsche Cayenne.  
**Opel:** Astra G, Zaphira B, Corsa C, Vectra C.  
**Honda:** Jazz, CRV, FRV, Accord, Turnier.  
**BMW:** 5º Modelo de EU 39 a 2005. 7º Modelo de E 38 a 2005  
**Audi:** A3, A4, A5, A6, Audi Q7.  
**Ford:** Galaxy, Alhambra.  
**Mercedes:** A-Class, B-Class.  
 - Projectado com pernas finas e extremos acabados em latão para evitar qualquer tipo de dano na carroceria, pintura ou vidro.  
 - Aplicável à maioria dos veículos do mercado.  
 - Seu manuseio permite uma extração segura dos limpa-pára-brisas evitando danos no braço.

## EXTRACTOR DE BRAÇO LIMPIAPARABRISAS

**52454** 0,2 6 36 576  
**11,00€**



## EXTRACTOR DE JUNTAS HOMOCINÉTICAS

**51364** 2 5 280  
**26,00€**



## EXTRACTOR DE POLIA

**51140** 1,02 24 290  
**59,00€**

- Desenhado para manter a polia da árvore de cames fixa.  
 - Permite o ajuste do eixo central quando se dá a junção.  
 - Usando a barra roscada para extrair a polia.  
 - Parafusos de fixação: M6, M8.



## EXTRACTOR SEMI-EIXO ESPECIAL DE 4 / 5 FUROS

**51231** 3,85 4 295  
**188,00€**

**51138** 3,95 4 296  
**188,00€**

- Este extractor inclui anilhas cónicas de extração. P.C.D. abrange 96-126 mm.  
 - Eles podem ser usados com ferramentas pneumáticas.



## KIT DE FERRAMENTAS DE LIMPEZA DE CUBOS, 14 PÇS

**54069** 0,24 10 40  
**28,00€**

Remove a sujeira e a corrosão da superfície dos cubos com pinos.

- 1 bico 8 mm com adaptador 1/2".  
 - 1 rebolo de eixo redondo e cabeça hexagonal de 8 mm.  
 - 2 almofadas removíveis com base autoadesiva.  
 - 5 rebolos de grão grosso, diâmetro externo de 40 mm.  
 - 5 rebolos de grão fino, diâmetro externo de 40 mm, diâmetro interno de 14 mm.  
 - Dimensões gerais de um conjunto: 30,5\*17\*2,5 cm  
 - Peso de um conjunto: 240 g



## REMOVEDOR HIDRÁULICO DO CUBO DA RODA

**53638** 13,35 1 28  
**236,00€**

- Este kit inclui: 3 extractores / martelos: eixo hidráulico, parafuso e martelo de impacto, especialmente projectados para simplificar a remoção do cubo da roda e liberar o eixo do cubo sem danificá-lo.  
 - Para extração manual ou hidráulica.  
 - Com uma capacidade máxima de 10 TON.  
 - Martelo de 4 kg.  
 - Comprimento da barra: 57cm.  
 - Para 3, 4, 5 e 6 furos.

VAG (VW, AUDI, SEAT, SKODA),  
 PSA (CITROËN, CITROËN DS, PEUGEOT),  
 RENAULT, FORD, OPEL, BMW,  
 MERCEDES BENZ

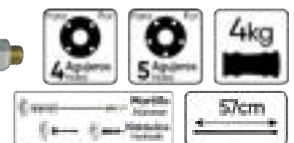

FUSO HIDRÁULICO

**15253**  
**57,00€**

## REMOVEDOR DE ROLAMENTOS DE RODA COM A PLACA DESLIZANTE DE CHOQUE

**53635** 6,50 2 84  
**69,00€**

- Maça deslizante: 4 Kg.  
 - Faixa de diâmetro: 100-115mm.  
 - Para parafusos M12.  
 - Comprimento: 457mm.

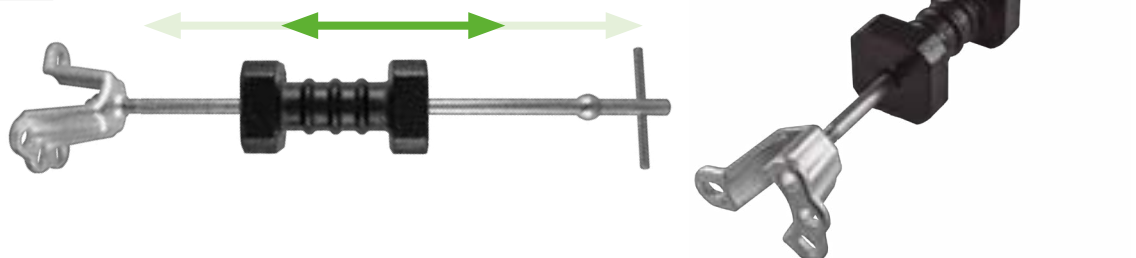

## EXTRACTOR DE TUBOS DE ESCAPE

51999

4,93 4 120

87,50€



- Abertura: Min. 50mm, Max. 70mm.
- Recorrido de enganche: 170mm.
- 4 Adaptadores de estriado.



## SET DE EXPANSÃO PARA TUBOS DE ESCAPE

52637

3,01 5 220

44,50€



1-1/8" - 1-3/4"  
1-1/2" - 2-1/2"  
2-1/8" - 3-1/2"

## INSTALADOR AJUSTÁVEL DE RETENS

53129

0,96 2 10 180

70,50€



18 - 90mm



## EXTRACTOR DE ABRAÇADEIRAS HENN

53696

0,1 6 96

19,50€



- Volkswagen, Audi, Seat, Škoda, BMW, Peugeot, Citroën, Dacia, Fiat, Ford, Kia, Lexus, Mazda, Mercedes, Nissan, Opel/Vauxhall, Porsche, Renault, Toyota, Volvo.

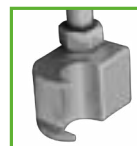

## SET DE 2 GANCHOS PARA EXTRAIR BORRACHA DA TUBO DE DESCARGA

52849

0,22 10 40 480

7,50€



## JOGO DE 3 CHAVES PENTAGONAIS

51996

0,4 5 40 960

8,00€



19mm

14mm

10mm



## CHAVE DINAMOMETRICA COM CABEÇAL INTERCAMBIABLE 200NM

**52913**  
292,00€

3,94 4 128

- Certificado de calibração de fábrica incluído.

1/2"

- Par de aperto: 40-200Nm.
- Cabeçales incluídos: Chaves 13, 14, 15, 17, 19, 22, 24, 27, 30mm.
- Cabeça catraca 1/2".
- Diferentes cabeças disponíveis separadamente.

18x14mm



325mm



## CHAVE DE TORQUE COM O APROFUNDAMENTO

- Certificado de calibração de fábrica incluído.

**53081**

115,00€

1,08 5 25 200

1/4"

4-20NM (36T)

375mm

**53082**

148,00€

1,85 4 8 204

1/2"

40-210NM (24T)

560mm



## CHAVE DINAMOMÉTRICA

- Certificado de calibração de fábrica incluído.

**51262**

51,00€

0,83 4 16 384

1/4"

270mm

2-24 Nm  
0,2 - 2,4 M.Kg

**51338**

52,50€

1,09 4 16 288

3/8"

365mm

19-110 Nm  
1,9 - 11 M. Kg

**51127**

55,50€

1,73 4 8 240

1/2"

470mm

28-210 Nm  
2,9 - 21,4 M. Kg



**24**

**DINAMOMÉTRICAS**

**53972**

515,70€

8,75 2

3/4"

1000-1.210mm

200-800 Nm  
21,4 - 81,6 Kg

1.210mm

1.000mm

## CONJUNTOS DE REPARO

**51262R**

990€

0,05 20

**51338R**

990€

0,05 20

**51127R**

990€

0,05 20

51262

51338

51127

IVA não incluído

JBM

www.jbmcamp.com

203

JBM

## CHAVE DINAMOMÉTRICA MECÂNICA

51830

76,50€



- Certificado de calibração de fábrica incluído.

- Exactitude: CW: +/- 4%
- Alcance de operação: 2-10 N-m
- Unidades de selecção: N-m, in-lb.
- Comprimento (mm): 242mm
- Dedo: 1/4"
- Vida útil: 100.000 ciclos



## GONIOMETRO 3/4"

52793

37,00€



- Útil para apertar os parafusos de acordo com especificações determinadas pelos fabricantes de veículos e máquinas.
- Aperte feita pela catraca ou 3/4 "chave de torque.
- Janela transparente para uma visão correta da medição.
- Faixa de medição 0-360.
- Em blister.

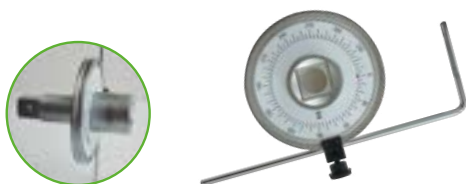

## CALIBRE DE PROFUNDIDADE COM SUPORTE MAGNÉTICO

52904

55,50€

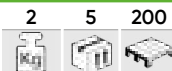

- Medição: 0-10mm.
- Calibrado: 0,01mm.
- Esfera: 58mm.
- Base magnética: 40kg.



CALIBRE DE PROFUNDIDADE PARA REF. 52904

13704

21,00€



## GONIOMETRO 1/2"

52583

7,50€



## GONIÓMETRO DE 1/2" IMANTADO

52794

24,00€



- Útil para apertar os parafusos de acordo com especificações determinadas pelos fabricantes de veículos e máquinas.
- Aperte feita pela catraca ou 3/4 " chave de torque.
- Janela transparente para uma visão correta da medição.
- Faixa de medição 0-360.
- Em blister.

## APALPA FOLGAS

52433

4,80€



0,05 - 1mm

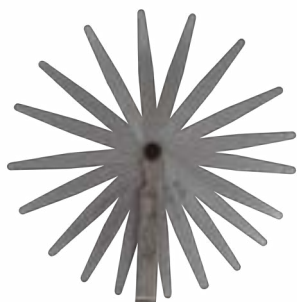

## PÉ DE REI

50937

10,00€



MECÂNICO

150mm

50724

24,50€



DIGITAL

150mm



## MEDIDOR DE PROFUNDIDADE DIGITAIS

53042

9,90€



0-25,4mm



## CALIBRE DE PROFUNDIDADE

52873

9,50€



0-40mm

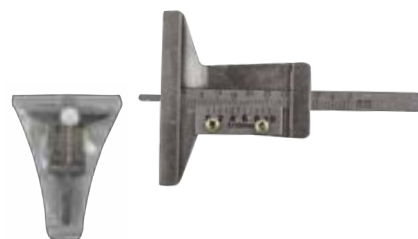

## DESMULTIPLICADOR DE FORÇA ARTICULADO

52796

8,88

3

72

6.000Nm

85,20€



- Use um camião com tampa de cubo de roda e protetor.
- Previne danos ao aro.
- Único no mercado.
- Fácil adaptação a qualquer veículo universal.
- Útil para aparafusar sem esforço e desenroscar.

- Inclui:  
1x chave 1" 32mm.  
1x chave 1" 3mm.



1:58

## DESMULTIPLICADOR DE FORÇA

52012

2,34

4

128

PARA AUTOMÓVEL

1/2"

66,50€



- Alcance: 1:18.
- Par máx. saída: 360Nm.
- Par máx. torção: 800Nm.

- Inclui:  
1 desmultiplicador de par.  
1 palanca de extensão 90°.  
Chaves 17mm, 19mm e 21mm.

## DESMULTIPLICADOR DE ROQUETE 3/4" + REDUCTOR DE 1/2"

51958

4,35

4

96

340,00€



- Características:  
Relação de transmissão 1:4.  
Relação de par 1:3.3.  
Par máximo de entrada: 303Nm.  
Par máximo de saída: 1000 Nm.

- Inclui:  
1 Desmultiplicador de par.  
1 Roquete manual.  
1 Adaptador 1/2" M x 3/4" F.  
1 Kit de desbloqueio.  
1 Palanca de extensão 90°.  
1 Palanca de extensão 350mm.

## DESMULTIPLICADOR DE FORÇA COM AUMENTO

51919

7,86

3

120

72,00€



- Material: 40CR.
- Potência máxima: 5800Nm.
- Potência de trabalho: 3800Nm.
- Múltiple alcance 1:56.
- Inclui chaves de 32mm e 33mm de 1".



## KIT DE 8 CHAVES 1" DESMULTIPLICADOR DE FORÇA

52056

5,50

4

128

61,00€



1"

8 PCS

22, 24, 27, 30, 32,  
33, 38, 41mm



### DESMANCHA DISPONÍVEL

REF.	DESCRIÇÃO			€	REF.	DESCRIÇÃO			€
10672	32mm	0,58	1	9,50€	10674	27mm	0,54	1	9,50€
10673	33mm	0,58	1	9,50€	10675	30mm	0,54	1	9,50€



## KIT CENTRADOR DE EMBREAGEM SAC

53001

9,69

1

40

222,00€



- A ferramenta especial de pré-carga da embreagem, impede que o anel de aperto rode no prato de pressão da embreagem.

- A não utilização da ferramenta especial pode provocar danos no prato de pressão da embreagem e provocar um falho do conjunto da embreagem.

- Adequado para quase todas as embreagens SAC (auto-ajustáveis).

- Vantagens:

Tensado da placa de pressão do embreagem em o montagem e desmontagem. Reposição mola de ajuste com a ferramenta de reinicialização. Centralização da válvula com respeito ao rolamento guia.

- Conteúdo:

Tensor de Embreagem. Centralizador de 3 braços. Ferramenta para repor parâmetros de origem. Jogo de pinos centralizadores. Centralizador de 4 braços.



PARA:  
VW  
Audi  
Bmw  
Mercedes  
Volvo  
Renault  
Opel

## RECÂMBIO DE GAS

51986

0,18

24

1.584

9,80€



200ml



## MAÇARICO

51920

0,15

10

100

900

18,00€



- Gás não incluído.



## JOGO DE TOMADAS ESPECIAL PARA AUTOMÓVEL 10 PCS

53669

0,70

5

20

45,00€



TOYOTA, NISSAN, RENAULT,  
OPEL ASTRA G/ZAFIRA, SMART, CITROËN,  
PEUGEOT, HONDA CIVIC



### CONTÉM

	10S	para engrenagem interdiária Toyota
	6S	para embreagens, cabeça do bloco de cilindros e eixo de equilíbrio Nissan e Renault
	8S	para embreagens, cabeça do bloco de cilindros e eixo de equilíbrio Nissan e Renault
	12S	para embreagens, cabeça do bloco de cilindros e eixo de equilíbrio Nissan e Renault
	8TS	para eixo balanceador Nissan

	14 mm	para pinças de freio Opel Astra G, Opel Zafira e Smart
	10 mm	para sistema de freio e bomba de combustível Nissan
	12,5 mm	para sistema de freio e bomba de combustível Nissan
	19 mm	para pinças de freio Peugeot, Renault e Citroën
	20 mm	para braço de controle inferior Honda Civic



## CENTRALIZADOR DE EMBREAGEM SAC

53410

1,6

5

230

79,50€



- Diâmetro centradores:  
15-19 / 20-26,6 / 23-36mm

- Diâmetro acessórios:  
12, 14, 15, 16, 17, 18, 19, 20mm



## KIT DE REPARAÇÃO DO EMBREAGEM DUPLA FACE PARA LA TRANSMISSÃO DSG DE VAG

53057

6,04

2

134,00€



- Para serviço em câmbios DSG em Golf (2004-), Golf Plus (2005-), AUDI A3 (2004-) com transmissão de 7 velocidades código OAM, e em Touareg (2003-) com transmissão de 6 velocidades código 08D).  
- Referências OEM dos úteis T10323, T10373, T10374.



## CENTRALIZADOR DE EMBREAGENS

53392

0,6

25

47,50€



2  
PCS

Ø 20 - 26mm



Ø 15 - 19mm



## CENTRADOR EMBREAGENS PLÁSTICO UNIVERSAL

52495

0,2

4

48

864

14,50€



- Centralizador de embreagem útil para a maioria dos modelos do mercado.  
- Inclui 3 adaptadores de diferentes diâmetros.



# SET DE COMPROVAÇÃO, ENCHIMENTO E ESVAZIAMENTO DE SISTEMA AACC

53456

2,8 5 75

BAR

93,00€



- Tente variações sobre os lados dos sistemas de alta e baixa pressão de ar condicionado do veículo.

- Blocos de alumínio leve com vista vidro e alta antivibrático legível.  
- Acopladores de serviços profissionais (codificados por cores e rotulados).  
- Três mangueiras de carregamento, codificados por cores e um gancho de suspensão para permitir o uso de mãos-livres.

- Aplicação: R134a, R12.  
- Comprimento da mangueira: 1550mm.

- Alta pressão: 0-34 BAR.  
- Pressão baixa: 0-24 BAR.

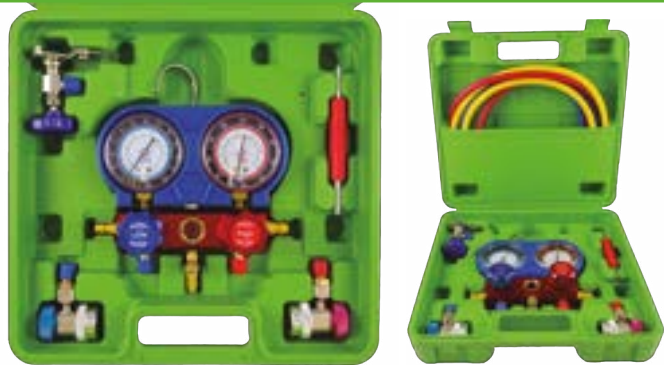

ACOPLADOR DE REMOÇÃO RÁPIDA DE ALTA PRESSÃO (REF. 53456)



14300

16,00€

0,20 100



ACOPLADOR DE REMOÇÃO RÁPIDA DE BAIXA PRESSÃO (REF. 53456)



14301

16,00€

0,20 100



## ADAPTADOR PARA CARGA DE GÁS 1234YF

ALTA

53499

29,00€

0,2 15 60



BAIXA

53500

29,00€

0,2 15 60



## LIMPADOR DE AR CONDICIONADO

54077

9,00€

0,40 24 1.152



CÂNULO FLEXÍVEL PARA NO. 54077

15314

3,15€

0,20 300



## CONJUNTO DE VÁLVULAS PARA O AR CONDICIONADO

53599

28,00€

0,15 10 100



134

PCS



R12 5mm L: 19mm	R12 6mm L: 19mm	R134A 7mm L: 20mm
R12 5mm L: 19mm	R12 6mm L: 22mm	R12 8mm L: 22mm
R12 5mm L: 19mm	R12 6mm L: 26.5mm	R12 9mm L: 22mm



## DESMANCHA DISPONÍVEL

REF.	MEDIDA	kg	PCS	€/u.
14594	5x19mm R12 (VERDE)	0,01	10	2,00€
14595	5x19mm	0,01	10	1,50€
14596	5x19mm R12	0,01	10	2,00€
14597	6x19mm	0,01	10	7,60€
14598	6x26.5mm	0,01	10	17,80€
14599	7x20mm R134A	0,01	10	4,50€
14600	6x22mm	0,01	10	9,50€
14601	8x22mm	0,01	10	11,00€
14602	9x22mm	0,01	10	11,00€

## CAIXA DE O'RINGS PARA AA/CC

50807

35,00€

0,16 5 50 750



5.29x1.78mm 20 PCS	6.07x1.78mm 20 PCS	6.8x1.9mm 20 PCS	7.65x1.78mm 20 PCS	7.80x1.90mm 20 PCS	8.0x2.0mm 20 PCS
8.80x1.90mm 20 PCS	10.82x1.78mm 15 PCS	10.77x2.62mm 15 PCS	11.0x2.0mm 15 PCS	12.0x2.0mm 15 PCS	13.9x1.80mm 10 PCS
13.95x2.62mm 10 PCS	14.0x2.0mm 10 PCS	15.0x2.0mm 10 PCS	17.0x2.00mm 10 PCS	17.17x1.78mm 10 PCS	17.04x3.53mm 10 PCS

270  
PCS

## KIT PARA A DESCONEXÃO DO AR CONDICIONADO

53459

64,00€

1,05 10 190



## KIT DE FERRAMENTAS PARA AR CONDICIONADO

53457

23,00€

0,35 10 20



CONTÉM

x1 1/4"

x7 TS10H, TS15H, TS20H, TS25H, TS27H, TS30H, TS40H,

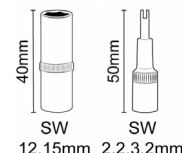



## KIT DETECÇÃO FUGA AA/CC

53539

1,35 5 165

68,00€



- Conjunto especialmente concebido para detectar perdas de pressão de ar condicionado e sistemas de refrigeração com facilidade.  
- Consiste na inserção de um líquido neutro fluorescente no circuito para detectar a fuga rapidamente.

- Contém:  
1x lâmpada UV 100Lm.  
1x óculos de visão UV.  
1x seringa inserção líquido.  
1x adaptador rápido.  
1x adaptador de extensão.  
1x pila recarregável.  
1x carregador.



LÍQUIDO DE DETECÇÃO FUGA SISTEMA AA/CC

12977

0,33 3 12 384

33,00€



250ml

- Uma aplicação de 7,5 ml para 1.4L de refrigerante.



ÓCULOS UV (REF.53539)

14187

0,20 50

4,50€



BATERIA PARA 53539

15052

0,04 50

1,50€



SERINGA DE DETECÇÃO DE VAZAMENTO AA/CC

12200

1,10 50

12,00€



LANTERNA PARA 53539

15054

0,12 50

28,50€



CARREGADOR PARA 53539

15053

0,04 50

8,50€



## LÂMPADA PORTÁTIL COB ULTRAVIOLETA FLEXÍVEL COM BASE MAGNÉTICA

53530

0,3 5 20 620

43,50€



380mm 45mm

LUZ ULTRAVIOLETA

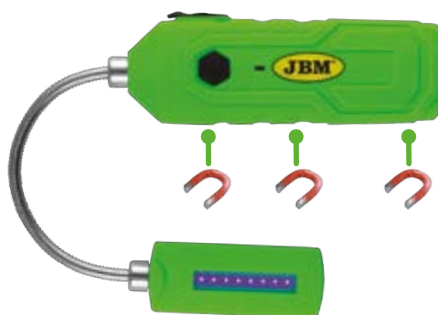

UV

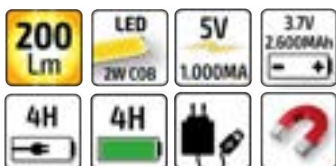

## KIT DE TESTE DE PRESSÃO DE REFRIGERAÇÃO

52687

158,50€



- Alcance de comprovação 0 -2,5 bar.  
- 19 cabeçóis de comprovação de radiadores específicos.  
- 1 cabeçal de comprovação de radiadores universais.



- 1: Bomba de pressão com válvula de descarga.
- 2A: conector 1: acoplador para os cabeçóis No.3(R123) e No.4 (R124); 2B: conector 2: acoplador para os cabeçóis No. 3(R123) y No. 5(R125)
- 3: Mercedes (W123, W126, W124, W201), GM(Buick), Jeep
- 4: Peugeot, Subaru, Chrysler, Acura, GM (Nova, Spectrum, Sprint), Mitsubishi, Nissan, Mazda, Toyota, Infiniti, GEO, Suzuki, Isuzu, Mercedes
- 5: Honda, Toyota, Suzuki, Mitsubishi, Chrysler, Acura
- 6: Mercedes Benz (ML, W163, W164), GM (Achiva, Skylark, Grand Am 1992-2002)
- 7: Volvo, Saab, Sterling, Citroen, Renault, Fiat, Alfa, Jeep

51339

199,00€



- Adaptador de 2.3".  
- Adaptador de 4.5".  
- Bomba de sistema de refrigeração.  
- Junta em forma de T de 5/16"-3/8".  
- Mangueira de óleo 5/16"-3/8".  
- 2 Abraçadeiras.



- 8: VW(Vento, T4, Passat-1996, Golf, Beetle, Sharan)
- 9: Audi(A4, A5, A6), BMW 345, VW(Passat-1997-2002), Porsche(Cayenne)
- 10: BMW (E46, E36, E34, E39, E38, E32, E90).
- 11: Audi, VW.
- 12: Internacional, Land Rover, Jaguar.
- 13: Mercedes.
- 14: Ford Focus.
- 15: Mazda(M3).
- 16: Mercedes classe A (W168).
- 17: BMW E60, E63, E64, E65.
- 18: VW SHARAN 1.8T 2.8.
- 19: TOYOTA-RAV4, PREVIA Adaptador universal de goma para purga e enchimento adores.
- 20: SAAB.
- 21: LAND ROVER.

- 1: GM, 4 cilindros (Buik, Chevrolet, Pontiac, Cadillac).
- 2: Camião.
- 3: Mercedes-Benz, Ford, Chrysler, GM, Jeep, Peugeot.
- 4: Acura, Dodge, Eagle, Geo, Honda, Isuzu, Lexus, Mazda, Mitsubishi, Suzuki, Toyota, Nissan, GM, Peugeot, Ford, Chrysler.
- 5: Toyota, Honda, Mitsubishi, Suzuki, Lexus, Chrysler, Acura, Dodge.
- 6: Buick, Chevrolet, Ford, Lincoln, GM, Opel, VW, Saab, Benz (classe ML) Jaguar,

- Rover.
- 7: Jeep, Renault, Saab, Volvo, Audi, Citroën, Fiat, Peugeot, Alfa.
- 8: VW.
- 9: Audi (A4, A6, A8) VW (Passat 1997-2002, Golf, Jetta).
- 10: BMW.
- 11: VW, Audi.
- 12: Ford, GM, Rover, Opel, Jaguar, BMW 245.
- 13: Mercedes-Benz Sedane.
- 14: Saab, Opel.



## JOGO DE ENCHIMENTO DE ÓLEO COM FUNIL E ADAPTADORES

**53485**

**139,50€**



**15  
PCS**

- Subaru (M42x4,5).
- Lexus, Pontiac, Scion, Toyota (M37x3,0).
- Ford, Jaguar, Land Rover, Mazda (M35x4,0).
- Acura, Dodge, Ford, Honda, Jaguar, Jeep, Land Rover, Mazda, Nissan, Acura (M32x3,5).
- Audi, BMW, Mercedes, Porsche, Volvo, VW.
- Toyota, Lexus, Scion, Pontiac.
- Dodge (M30x3,0).
- Mazda (1/2" Turn).
- Cadillac, Chevy, Ford, GMC, Hyundai, Jaguar, Land Rover, Mazda, Mercury, Saab (1/2" Turn).
- Audi, VW, Skoda (1/4" Turn).
- Dodge (1/2" Turn).
- Lexus, Pontiac, Scion, Toyota (M37x3,0).



**53347**

**99,00€**



**8  
PCS**



## KIT DE TESTE DE PRESSÃO DE VAZIO

**54016**

**71,00€**



Juntamente com a bomba de vácuo, o kit inclui um conjunto de bicos, adaptadores, plugues, juntas de borracha e medidores para sangrar e verificar o sistema de freio de maneira adequada e fácil.

Pressão máxima: 40 psi (3 bar)  
Pressão mínima: -20 psi (-0,75 bar)



**MAX  
40 PSI  
3 bar**

**MIN  
-20 PSI  
-0,75 bar**



SISTEMA DE REFRIGERACION

## TESTADOR DE VAZAMENTO PARA JUNTA DE CABEÇA DE CILINDROS

**53662**

**82,00€**



- Esta ferramenta foi projetada para verificar vazamentos entre a combustão e o sistema de resfriamento de motores refrigerados a água.
- O processo de combustão produz (entre outros gases) 13-14% de CO2 no escape, e vazamentos desse gás no sistema de refrigeração são facilmente detectáveis.
- Se houver gases de combustão, a cor do fluido de teste mudará para amarelo ou verde e isso será uma prova do vazamento de CO2 no refrigerante.

- Contém:  
Garrafa redonda de 200ml.  
Garrafa quadrada de 250 ml.  
Adaptadores:  
Pequeno: Suzuki, Toyota, Mitsubishi.  
Médio: Suzuki, Toyota, Mitsubishi, Subaru, Peugeot, Nissan, Lexus, Mazda.  
Grande: Ford, GM, Benz, JEEP.



FLUIDO DE TESTE DE FUGAS DE COMBUSTÃO



**14563  
18,00€**



## CONJUNTO DE BITS TORX DE 6 PEÇAS 1/2" TIPO E EXTRA LONGOS

53915

57,50€



**E12** Socket for BMW cylinder head:  
 - M42 engine, 1.8L, 4 cylinders, 16V, model 318 is from 1989  
 - M50 engine, 2.0L, 2.5L, 6 cylinders, 24V, model 520i, 525i from 1991

### CONTÉM

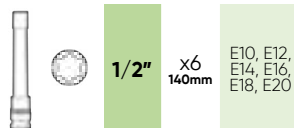

6  
PCS

1/2"

CrV

CINCADO

## GRAMPO DE VÁLVULAS

51120

39,80€



- Apto para carros e motos.
- Os 5 adaptadores permitem um encaixe correcto e fácil para comprimir a mola da válvula.

- Compressor de Molas.
- Adaptador de: 30, 25, 23, 19, 16mm.

## GRAMPO DE MOLHA DE VÁLVULAS 45-145MM

52734

43,50€



45-145mm

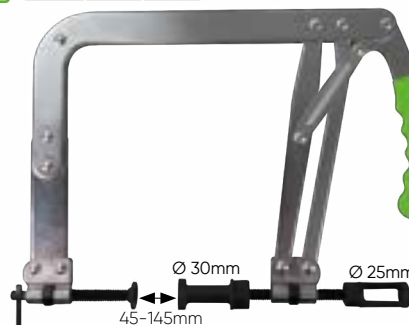

## ORGANIZADOR PARA COMPONENTES DO MOTOR

53637

84,50€

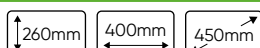

- Especial para peças de cabeçotes.
- Mantém todos os componentes limpos e arrumados à medida que são removidos da cabeça do cilindro.
- Economize tempo. Isso facilita o seu trabalho.

## GRAMPO DE MOLHA DE VÁLVULAS

52693

24,50€



- Válido para os motores OHV, OHC, CHV.
- Permite o reemplazo das molhas e sellos de válvulas com a cabeça del cilindro montada.
- Capacidade para comprimir u extraer.
- Com grampo / adaptador reversible e bloqueio da posição predeterminada.



## FERRAMENTA PNEUMÁTICA POLIMENTO VÁLVULAS - PERCUSSÃO E ROTAÇÃO

53572

275,00€



REGULA A VELOCIDADE

- Conteúdo:
- 1 x máquina pneumática para válvulas.
- 5 x ventosa (16, 20, 30, 35 e 45 mm).
- 5 x adaptador de válvula.
- Chave Allen de 1 x 3 mm.



14157  
7,50€

14158  
5,00€

14159  
11,00€

14160  
6,50€

14161  
12,00€



VIRAR À DIREITA +  
VIRAR À ESQUERDA

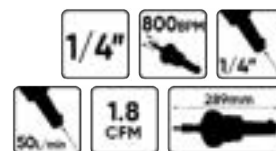

## KIT COMPRESSOR DE MOLAS

51121

26,00€



- Garras e pernos reforçados com aleação de ferro - carbono (termo-tratados).
- Indicada para usar em espaços limitados e baixo o arco da roda.
- Abertura máxima: 250mm.



## COMPRESSOR MOLAS PARA AMORTECEDORES 1T

53742

66,50 1 6

999,00€



- Capacidade de carga: 1000 kg
- Máx. comprimento de trabalho: 450 mm
- Curso do cilindro: 420 mm
- Diâmetro da mola: Ø102-165mm
- Direção do enrolamento: sentido horário
- Princípio de funcionamento: pneumático
- Pressão do ar: 6,5-9 bar (94,27-130,53 psi / 0,65-0,9 MPa)
- Modo de operação: pedal de pé

1410mm 690mm 560mm

1T



FORNECIDA COM FONTE DE ALIMENTAÇÃO PNEUMÁTICA

## COMPRESSOR DE MOLAS

53394

297 1 18

584,50€



- Kit profissional que permite remover e instalar rapidamente as molas da suspensão dianteira e traseira sem desmontar o eixo.
- Braço telescópico e superfícies antiderrapantes que permitem um aperto sólido das molas.
- Garras equipadas com uma proteção de plástico intercambiável para evitar danificar a pintura da mola.
- Impede que as molas se dobrem na compressão.
- Universal, cobre 90% da frota de veículos.
- Pode ser usado tanto para molas retas como cónicas.

- Conteúdo:  
Dispositivo / pistão.  
Três pares de grampos  
com tampas de plástico.



## COMPRESSOR MOLAS PARA AMORTECEDORES

50827

32,45 1 18

387,00€



1T

- Capacidade: 1T (2200 lbs)
- Diâmetro da mola comprimida: 200mm
- Comprimento de compressão: 200-500mm

830mm

350mm

190mm

200-500mm



## KIT PARA REMOÇÃO DE AMORTECEDOR

53118

6,66 2 42

204,50€



39 PCS

CRV 6140  
CRMO  
SCM415  
CRV 50BV30





## COMPRESOR DE MOLAS PROFESSIONAL McPHERSON

52227

198,00€

15,1

1

24

- BMW, Toyota, Ford, Mitsubishi, VW, Audi, Saab, Nissan, Honda Accord, Subaru, Volvo, Opel, Porsche.

- Especificações  
Carga máxima: 2500N.  
Um corpo principal.  
Um suporte estendido.  
3 pares de mandíbulas.

- Par 1: Alcance de uso: 80-115mm. Peso: 1.45kg.  
- Par 2: Alcance de uso: 110-195mm. Peso: 2.2kg.  
- Par 3: Alcance de uso: 140-195mm. Peso: 2.3kg.



NÃO USAR COM PISTOLA NEUMÁTICA

## MEDIDOR DE CAMBER IMANTADO

52318

64,50€

0,64

6

24

336

-6°/+6°



## ALINHADOR DE QUEDAS (VAG)

53488

56,50€

2,75

5

200

22mm



Largura de pressão:  
135-175mm

- Permite que uma única pessoa ajuste o ângulo de queda da roda.



- Inclui:  
Fuso hexagonal de 22 mm.  
3 comprimentos diferentes:  
- 75mm: Seat - Toledo | VW - Jetta / Golf.  
- 85mm: Seat - Córdoba | VW - Polo / 95>.  
- 115 mm: Chrysler - Voyager.

## CORTADOR DE CADEIA DE MOTOCICLETA

53665

15,50€

0,35

10

60

25-60



53666

22,00€

0,70

5

30

60-100

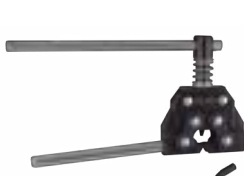

53665



53666

## DESMONTADOR E REBITADOR DE CADEIA DE MOTOCICLETAS

53055

30,50€

0,89

10

600

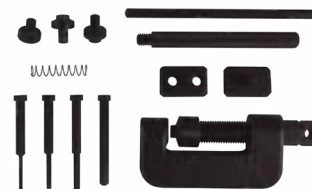

## BRACADEIRA PARA PRENDER BATERIA

52319

8,20€

0,16

12

48

720

52621

0,14

10

40

800



x2

## LIMPA BORNES DE BATERIA

52613

21,00€

0,57  
6  
18  
360



110-190mm

## KIT DE LIMPEZA DE ASSENTOS DE INJETORES

53650

48,00€

0,90

5

180

- Kit com três escovas de aço com revestimento de latão para limpar os depósitos de carbono restantes das paredes laterais do ASSENTO INJETOR, bem como duas escovas de nylon de silicone para limpar a base do ASSENTO.  
- As escovas de limpeza podem ser rapidamente conectadas à extensão flexível fornecida.  
- Este kit também contém seis tampões de vedação e uma haste de inserção para impedir que depósitos de carbono entrem acidentalmente na câmara de combustão durante o processo, além de uma escova de aço de pequeno calibre para limpar o fundo do ASSENTO.

- Contém:  
3 escovas de latão.  
2 escovas de silicone-nylon.  
1 extensor.  
6 tampões de fechamento para vedação da câmara de combustão.  
1 haste para inserção dos bujões de fechamento.  
1 escova de aço para limpeza da cabeça do cilindro.

CONJUNTO DE 3 ESCOVAS DE LIMPEZA DE LATÃO (REF.53650)

14348

12,50€

0,05  
50

CONJUNTO DE 2 ESCOVAS DE LIMPEZA DE SILICONE (REF.53650)

14349

20,50€

0,07  
50

## KIT DE FERRAMENTAS PARA AROS DE PISTÃO

**53251**

88,00€

	2,80
	4
	72



- Conjunto completo de aros e anéis de pistão.
- Pinça ou alicate para instalar segmentos de pistões.
- O aperto dos cintos tem um sistema de roquete dentado.



**H:3"**  
Ø 53-125mm

**H:4"**  
Ø 60-175mm

**H:6"**  
Ø 60-175mm

## COMPRESSOR AROS PISTÃO

**52697**

12,50€

0,55	5	40	480
------	---	----	-----

**6"**

Ø 60-175mm

**52696**

8,00€

0,29	5	40	1.280
------	---	----	-------

**3"**

Ø 53-175mm



## KIT 38 ESCOVAS DE LIMPIEZA METAL / PLÁSTICO

**51989**

46,00€

1,64	10	120
------	----	-----



- 1 Cabo de 1/4".
- 1 Alargador.
- 36 escovas.

Ø 8, 9, 10, 11, 12, 13, 14, 15, 16, 17, 18, 19mm

**38 PCS**

## CHAVE PARA TAPA DE AFORADORES

**53096**

26,50€

	1
	5
	10
	320



89-170mm

15mm



## ESCOVAS METÁLICAS

**52760**

4,10€

0,09	12	120	2.160
------	----	-----	-------

**52515**

9,10€

0,15	6	72	800
------	---	----	-----

225mm

**3 PCS**



- 1 x latão.
- 1 x nylon.
- 1 x aço.

## EXTRACTOR UNIVERSAL DE AFORADORES

**52757**

16,00€

0,55	5	20	360
------	---	----	-----



160mm  
75mm



## CHAVE VASO ESPECIAL PARA MOTAS

**53054**

4,00€

0,16	12	72	1.500
------	----	----	-------

19, 22, 24mm



## CHAVE PARA MOTAS

**53086**

9,00€

0,19	12	72	1.500
------	----	----	-------

17, 19, 22, 24mm

**3/8"**

Yamaha, Kawasaki, BMW, Suzuki, Honda



## POLIDORA DE CILINDROS

### 2 BRAÇOS

**52591**

12,00€

Ø ↑ 55mm  
↓ 19mm

28,6mm

1-1/8"

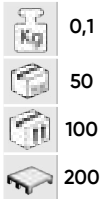

### 3 BRAÇOS

**52592**

19,00€

Ø ↑ 85mm  
↓ 35mm

50,8mm

2"

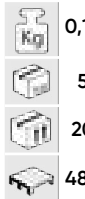

**52593**

31,30€

Ø ↑ 170mm  
↓ 55mm

101,6mm

4"



**PASTILHA DE POLIR 1 - 1/8" EM BLISTER DE 2 UNIDADES PARA REF. 52591**

**11878** 0,02 50  
4,10€

**PASTILHA DE POLIR 2" EM BLISTER DE 3 UNIDADES PARA REF. 52592**

**11879** 0,04 60  
5,10€

**PASTILHA DE POLIR 4" EM BLISTER DE 3 UNIDADES PARA REF. 52593**

**11880** 0,04 25 100  
10,50€



## PISTOLA ESTROBOSCÓPICA

### DIGITAL

- Ajuste de ignição de motores.

**53474**

78,00€

0,85 20 160 12V 1.8m 0,1° 9.000  
3,6W



2 PINÇAS

SENSOR INDUTIVO

**53240**

58,00€

0,75 5 20 160 12V 1.5m  
3,6W



2 PINÇAS

SENSOR INDUTIVO

## ESTETOSCÓPIO ELECTRÔNICO

**53249**

175,00€

2,85 5 50  
9V

- Kit adequado para detecção de falhas em coletores de admissão/escape, injectores, radiadores, etc.
- Permite a auscultação de diversos pontos do veículo de forma simultânea facilitando o trabalho do operário na hora de encontrar e diagnosticar avarias.
- Sondas marcadas por cor que facilitam o trabalho do operário.
- Inclui velcro de fixação para os sensores.

- Características
- Comprimento do cabo sensor: 4,8 m
- Comprimentos da sonda de áudio: 14 cm
- Baterias de 9V (incluída)
- Quantidade de sensores: 6
- Adequado para conector de 3,5 mm
- Comprimento ajustável do microfone: 21 cm



## ESTETOSCÓPIO

**51347**

9,00€

0,15 5 50 300  
9V

- Aumenta e localiza ruídos internos mecânicos e de passagem de fluidos.
- Localiza a fonte de ruído do motor rapidamente.
- Escuta os problemas de localização de fluidos de água, petróleo, gás ou vapor.
- Ponta à prova de golpes.



Ø 12mm

## FERRAMENTA DE DESMONTAGEM DE CONECTORES

**53663**

6,50€

0,01 10 100  
9V

VAG



- Ferramenta para desmontar conectores em veículos do grupo VAG sem danificá-los.





## CONJUNTO DE FERRAMENTAS PARA AJUSTAR FARÓIS

53729

18,00€

0,40 10 40



## REMOVEDOR PARA MAÇANETAS VAG

53655

11,50€

0,09 12 96



## PORTAPUNTAS ANGULAR

52620

8,00€

0,05 6 36 1.584



37mm

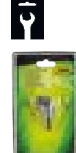

- Para áreas de difícil acesso.  
- Com a função de plugue rápido.  
- Extrair facilmente.

- Broca de 6mm.

## GRAMPO PARA ABRIDORES DO CAPO E PORTA-MALAS

53525

11,00€

0,08 5 30 300



## CABO EXTENSÍVEL MULTIFUNÇÃO

52497

18,00€

0,29 6 48 480



↑120mm

↓53mm



53196

21,00€

0,3 6 48 576



↑160mm

↓71mm

- Para comprobar o funcionamento correcto das luzes de travão: esticando o cabo, um extremo pressionando o pedal do travão e o outro no volante.  
- Para determinar a pressão dos pneumáticos.  
- Para eliminar pequenas pedras ou cravos nas ranhuras dos pneumáticos.  
- Para levantar o capô convenientemente e comprobar o óleo do motor, bateria, correia, radiador, etc.

COM 3 SESCOES DE ALUMÍNIO

FORTE E LEVE



## KIT DE ALICATES PARA OCLUSÃO DE TUBOS

3 PCS

NYLON



52066

12,00€

0,28 5 40 450



1/2"

3/4"

5/8"

- Adequado para o circuito de travões, gasolina e refrigerante.  
- Fabricadas em material leve e isoladas eléctricamente.

∅ 0-20mm

∅ 0-35mm

∅ 0-70mm

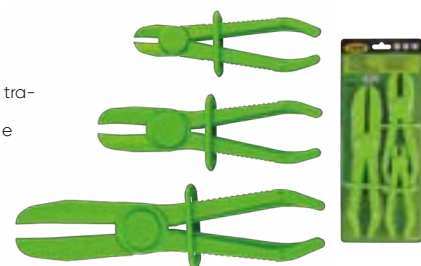

53395

16,00€

0,3 5 20 360



∅ 10, 15, 24mm



# CONJUNTO DE 3 BANDEJAS DE FERRAMENTAS ELÁSTICAS ANTI DERRAPANTE

**53903**

1,43 10

59,00€



- Materiale antiscivolo.
- Ideale per tutti condizioni operative, offre un accesso facile e comodo agli strumenti.
- Maniglia incorporata, portatile e comoda.
- Resistente all'olio.
- Resistente alle temperature fino a 140°C.
- Righello incorporato su entrambi i lati

- del vassoio.
- Scomparti separati per una corretta organizzazione degli utensili.
- Ventosa dal design unico per un fissaggio sicuro su superfici piane.



**VASSOIO PICCOLO**

**15010**  
16,50€

0,31 20

**VASSOIO MEDIO**

**15011**  
18,00€

0,31 20

**VASCHETTA GRANDE**

**15012**  
31,50€

0,82 10

- Piccolo: 285 x 137 x 27 mm
- Medio: 285 x 202 x 27 mm
- Grande: 543 x 300 x 27 mm
- Materiale: gomma morbida

## PRATO MAGNÉTICO FLEXÍVEL

- Prato de plástico flexível magnético para aguentar parafusos, parafusos e peças pequenas.

**52516**

25,50€

0,42 6 24 1.152

- Ø superior: 225mm.
- Ø base: 88mm.
- Medidas implementadas: 135mm.
- Medidas dobráveis: 43mm.

**52517**

5,50€

5,02 12 72 1.152

- Ø superior: 135mm.
- Ø base: 53mm.
- Medidas implementadas: 90mm.
- Medidas dobráveis: 31mm.



## MALGA MAGNÉTICA

**52466**

11,00€

0,43 1 20 180

Ø 150mm

112mm

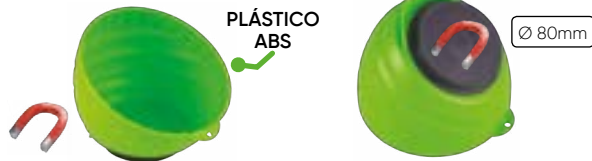

## PRATO MAGNÉTICO

**50787**

8,00€

0,31 36 648

x1 Ø 150mm



**50788**

14,50€

0,62 24 432

x1 239 x 139mm



## COLGADOR MAGNÉTICO

**52467**

10,00€

0,5 24 1.008

40mm 145mm 75mm

- Imán de grande alcance almofadado para evitar estragar as superficies.



## GANCHO MAGNÉTICO

**52378**

9,50€

0,36 10 40 720

3KG Ø 60mm



**51341**

35,00€

1,62 12 96

9KG Ø 70mm

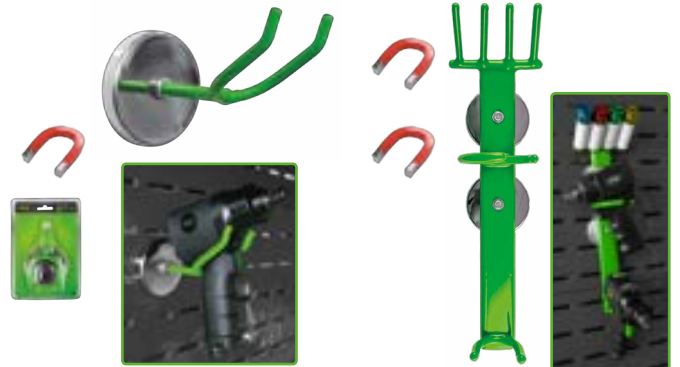

## KIT DE 2 ESTANTES COM IMAN

**50790**

29,00€

1,17 12 96

21x11,5cm

28x11,5cm

## CONJUNTO DE 5 ÍMÃS

**53958**

4,50€

0,05 10 100

5 PCS Ø 15mm



## BARRA MAGNÉTICA PARA FERRAMENTAS

**50789**

29,00€

0,89 10 20 300

600mm





BMW



218

MERCEDES



221

VAG



222

RENAULT / NISSAN



227

FORD / MAZDA



229

JAGUAR / LAND ROVER



230

OPEL / VAUXHALL



231

CITROËN / PEUGEOT



234

VÁRIOS



235

GABINETE COM FERRAMENTAS DE AJUSTE DE SINCRONIZAÇÃO



238



# KIT DE BLOQUEIO



ref. 53951 / 53952



## KIT DE BLOQUEIO BMW N42 / N46 1.8 / 2.0 CADEIA

**53259**  
97,00€

2,8 5 135

gasolina

<b>MARCAS</b>	BMW	BMW 1 SERIES: 118i E81/82/87/88 (04-14), 120i E81/82/87/88 (04-14). BMW 3 SERIES: 316i/ti Compact E46 (01-07), 318i/ti Compact E46 (01-07), 318i, E90/91/92/93 (05-12), 320i E90/91/92/93 (05-12). BMW 5 SERIES: 520i E60/61 (07-10), Z4 2.0 E85/86 (04-09). BMW X SERIES: X1 sDrive 18i E84 (10-12), X1 xDrive 18i E84 (10-12), X3 2.0 E83 (05-10).
<b>FERRAMENTAS OEM</b>	11.9.350 (1), 11.9.340 (2), 11.9.291 (3), 11.9.292 (4), 11.9.270 (5), 11.5.120 (6), 11.9.190 (7), 11.9.293 (8)	
<b>CÓDIGOS DE MOTOR</b>	1.8: N42; B18A, N46; B18. / 2.0: N42; B20A, N46; B20, B20B, N46T; B20, B20B, B20BD, B20BZ, B20O2, B2O2.	



## KIT DE BLOQUEIO BMW N43 1.6 / 2.0 CADEIA

**53260**  
230,50€

5,6 2 40

gasolina

<b>MARCAS</b>	BMW	BMW 1 SERIES: 116i E81/82/87/88 (07-12), 118i E81/82/87/88 (06-14), 120i E81/82/87/88 (06-14). BMW 3 SERIES: 316i E90/91/92/93 (07-11), 318i E90/91/92/93 (07-13), 320i E90/91/92/93 (07-14). BMW 5 SERIES: 520i E60/61 (07-10).
<b>FERRAMENTAS OEM</b>	11 8 690 (1) 8 691/11 8 692/11 8 693 (1), 11 8 710 (1) 8 711/11 8 712 (2), 11 3 340 (3) (4), 11 8 700 (5), 11 9 340 (1) 9 341/11 9 342 (6), 11 5 120 (7).	
<b>CÓDIGOS DE MOTOR</b>	1.6: N43 B16A/AA, B16AA, B16AA/OO. 2.0: N43 B20A, B20A/AA, B20AA, B20AY, B20KO, B20UO.	

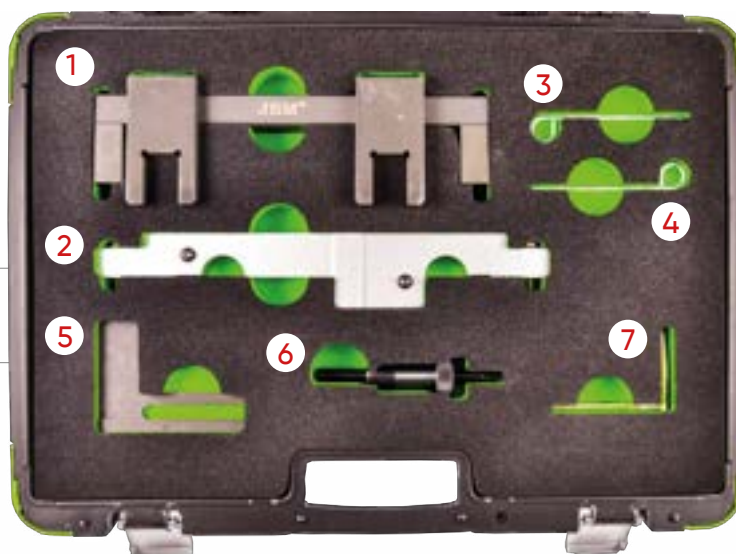

## KIT DE BLOQUEIO BMW N42 / N46

**53261**  
201,50€

5,2 2 40

gasolina

<b>MARCAS</b>	BMW	BMW 1 SERIES: 118i E81/82/87/88 (04-14), 120i E81/82/87/88 (04-14). BMW 3 SERIES: 316i/ti Compact E46 (01-07), 318i/ti Compact E46 (01-07), 318i E90/91/92/93 (05-12), 320i (E90/91/92/93 (05-14). BMW 5 SERIES: 520i E60/61 (07-10). BMW X SERIES: X1 E84 sDrive 18i (10-12), X1 E84 xDrive 18i (10-12), X3 E83 2.0 (05-10). BMW Z SERIES: Z4 2.0 E85/86 (04-09).
<b>FERRAMENTAS OEM</b>	11 9 190 (1), 11 9 310 (2), 11 9 302 (3)	
<b>CÓDIGOS DE MOTOR</b>	2.0: N42 B18A, N42 B20A, N46 B18, N46 B20, N46 B20B, N46T B20, N46T B20B, N46T B20BD, N46T B20BZ, N46T B20O2, N46T B2O2	

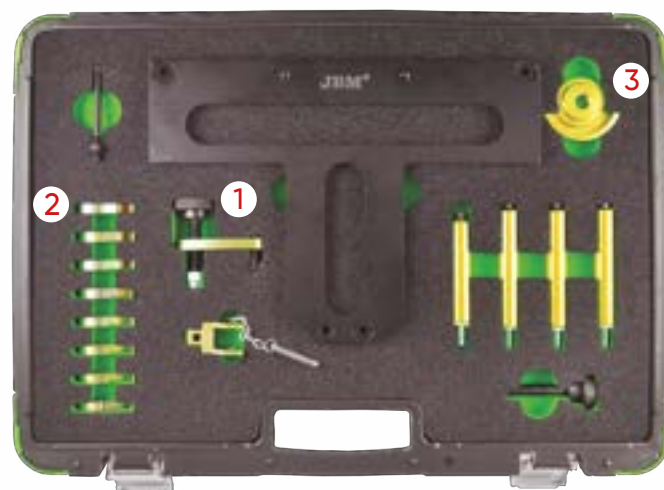

## KIT DE BLOQUEIO EIXO DE COMANDO BMW M52TU / M54 / M56 DUPLO VÃOS

53262

5,6 2 40

gasolina

233,00€

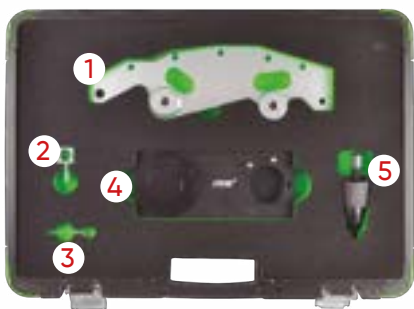

MARCAS

BMW

M52TUB25: 1997-2001 E46 323i/323Ci/323ti (M52T); 1998-2001 E39 523i (M52TU); 1998-2001 E36/7 Z3 (M52TU).  
M52TUB28: 1997-2001 E46 328i/328Ci (M52TU); 1997-2001 E36/7 Z3 2.8 (M52B28/Z3); 1998-2001 E39 528i (M52TU); 1998-2001 E38 728i (M52TU).  
M54B22: 2001-2003 E46 320i/320Ci; 2001-2003 E39 520i; 2001-2002 E36 Z3 2.2i; 2003-2005 E85 Z4 2.2i; 2003-2005 E60/E61 520i.  
M54B25: 2001-2002 E36/7 Z3 2.5i; 2001-2005 E46 325i/325xi; 2001-2006 E46 325Ci; 2001-2004 E46 325ti; 2001-2004 E39 525i; 2003-2004 E60/E61 525i/525xi; 2004-2006 E83 X3 2.5i; 2004-2006 E85 Z4 2.5i.  
M54B30: 2001-2005 E46 330i/330xi; 2001-2006 E46 330Ci; 2001-2003 E39 530i/2001-2002 E36 Z3 3.0i; 2003-2005 BMW E60 530i; 2003-2006 E85 Z4 3.0i; 2001-2006 E53 X5 3.0i.

FERRAMENTAS OEM

116150 (1), 113450 (2), 113292 (3), 116180 (4), 114220(5)

## KIT BLOQUEIO EIXO DE COMANDO BMW M47

53263

1,8 5 165

diesel

56,50€

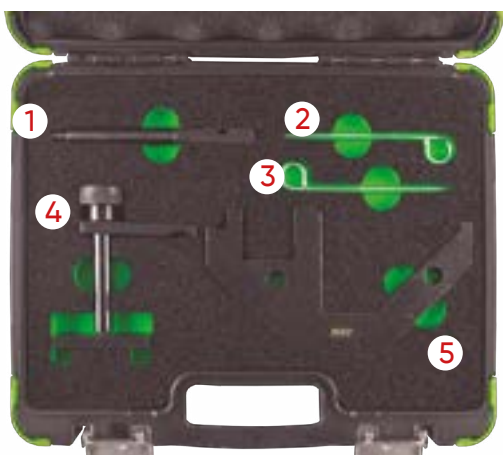

MARCAS

BMW

BMW 1 SERIES: 118d E87 (04-07), 120d E87 (04-07).  
BMW 3 SERIES: 318d/td Compact E46 (01-05), 318d/td E90/91 (05-08), 320d/td Compact E46 (98-05), 320d/cd E90/91 (05-08), 325d E90/91/92/93 (02-10), 330d/cd E46/90/91/92/93 (99-07), 335d E90/91/92 (06-11).  
BMW 5 SERIES: 520d E39/60/61 (00-09), 525d/xd E39/60/61 (00-10), 530d/xd E46/60/61 (98-10), 535d E60/61 (04-10).  
BMW 6 SERIES: 635d E63/64 (07-11).  
BMW 7 SERIES: 730d/ld E38/65/66 (98-08).  
BMW X SERIES: X3 2.0d E83 (04-07), X3 3.0d/sd E83 (03-10), X5 3.0d E53/E70 (00-10), X6 3.0d E71/72 (08-10), X6 3.5d E71/72 (08-10).  
LAND ROVER: Freelander Td4 (00-06), Range Rover Td6 (02-06).  
MG/ROVER: MG-ZT/T (01-05), Rover 75 CDT/CDTi (99-05).  
VAUXHALL/OPEL: Omega-B (01-03).

FERRAMENTAS OEM

11.2.300/12-108, 12-171/KM-813 (1), 11.3.340/12-172/KM-823 (2) (3), 11.6.322/12-174/KM-6267 (4) 11.6.320 (5)

CÓDIGOS DE MOTOR

BMW  
2.0D: M47, M47T2, M47TU / 2.5D: M57, M57T2, M57TU / 3.0D: M57, M57T2, M57TU  
LAND ROVER  
2.0D: 204D3 (TD4) / 3.0D: 306D1 (TD6)  
MG/ROVER  
2.0D: M47R / 2.0d CDT: M47R  
VAUXHALL/OPEL  
2.5D: Y25DT

## KIT DE BLOQUEIO BMW N62 / N73

53264

4,65 2 40

gasolina

141,50€

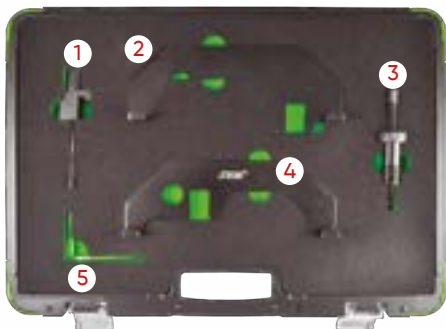

MARCAS

BMW

BMW 5 SERIES: 540i E60/61 (05-10), 545i E60/61 (03-06), 550i E60/61 (05-10).  
BMW 6 SERIES: 645i E63/64 (03-06), 650i E63/64 (05-11).  
BMW 7 SERIES: 735i E65/66 (02-05), 740i E65/66 (05-10), 745i E65/66 (02-05), 750i E65/66 (05-08), 760i E65/66 (02-08).  
BMW X SERIES: X5 4.4 E53 (03-07), X5 4.8 E53/E70 (04-10).

FERRAMENTAS OEM

11.9463 (1), 11.9462 (2), 11.9340 (3), 11.9461 (4), 11.9190 (5)

CÓDIGOS DE MOTOR

3.6 V8: N62 B36A 4.4 V8: N62 B44A 6.0 V12: N73 B60A  
4.0 V8: N62 B40A 4.8 V8: N62 B48B

## KIT DE BLOQUEIO BMW DIESEL

53265

5,45 2 40

diesel

185,50€

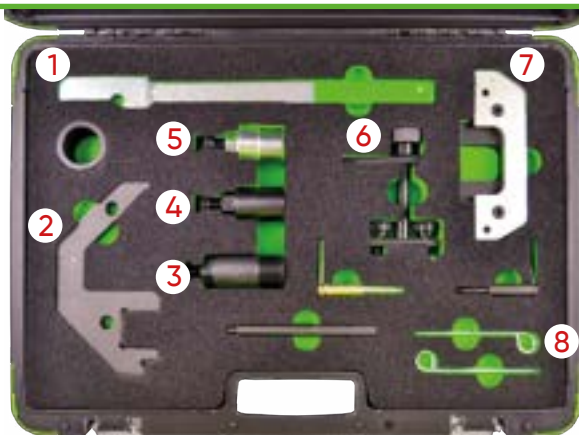

MARCAS

BMW

FERRAMENTAS OEM

113360 (1), 116321 (2), 135190 (3), 135191 (4), 135192 (5), 116322 (6), 112300 (7), 113340 (8)

CÓDIGOS DE MOTOR

Motor Diesel M41 / M51 / M47TU / M47TU T2. M57TU T2 3.0i 1998 - 2008.

## KIT DE BLOQUEIO BMW

53266

210,00€

6,3

2

42

diesel

gasolina

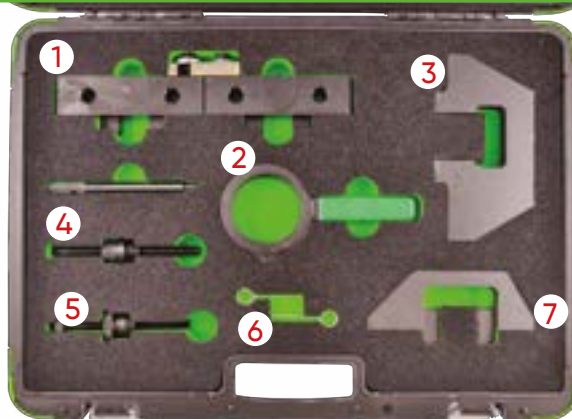

### MARCAS

BMW

### FERRAMENTAS OEM

113240 (1), 115490 (2), 113190 (3), 112300 (4) (5), 113292 (6), 113320 (7)

### CÓDIGOS DE MOTOR

GASOLINA: M42, M43, M50, M52, M60.  
DIESEL: M51

## KIT DE BLOQUEIO BMW M42 / 44 / 50 / 52 / 54 / 56

53267

255,50€

8

2

40

gasolina



### MARCAS

BMW

SERIES: 3, 5, 7, X, Z

### FERRAMENTAS OEM

114220 (1), 112300 (2), 113240 (3), 115490 (4), 113292 (5), 113450 (6)

### CÓDIGOS DE MOTOR

M40. M44. M50. M52. M54. M56.

## KIT DE BLOQUEIO BMW MINI / PSA 1.4 / 1.6

53268

92,00€

2,65

5

135

gasolina

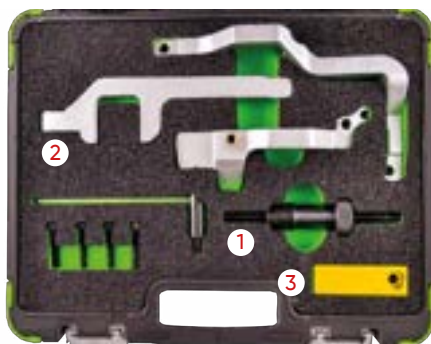

### MARCAS

BMW MINI: Mini Clubvan R55 (12-14), Mini Clubman R55 (08-14), Mini Countryman R55 (07-10), Mini Clubman R56/R57 (07-15), Mini R56/R57 (08-15), Mini Coupe R58 (11-15), Mini Roadster R59 (08-15), Mini Clubman R60 (10-14), Mini Clubvan R60 (12-14), Mini Roadster R61 (13-15), Mini Paceman R61 (14-15), Mini Countryman R60 (10-17).  
CITROËN: C4 (08-11), C4 Picasso (08-13) C4 Grand Picasso (13-15).  
PEUGEOT: 207 (06-14), 207CC (07-15), 308 (07-15), 3008 (09-15), 5008 (09-15).

### FERRAMENTAS OEM

BMW MINI: 11 5 590 (1), 11 9 340 (2), 11 9 551 (3)  
CITROËN: 0197-A1, 0197-A3, 0197-B.  
PEUGEOT: 0197-A1, 0197-A3, 0197-BZ.

### CÓDIGOS DE MOTOR

14: N12B14, N14B14AB.  
16: EP3(8FS), EP3C(8FR), EP6(5FW), EP6C(5FS), EP6CDT(5FV), EP6DT(5FT), EP-6DT(5FX), EP6DTS(5FY), N14B16A, N14B16CD, N14B16TO, N14B16CD/TO, N16B16A, N16B16KO, N16B16A/MO, N16B16A/MO, N16B16MO, N16B16UO.

## KIT DE BLOQUEIO BMW

53269

49,50€

1,25

5

10

diesel

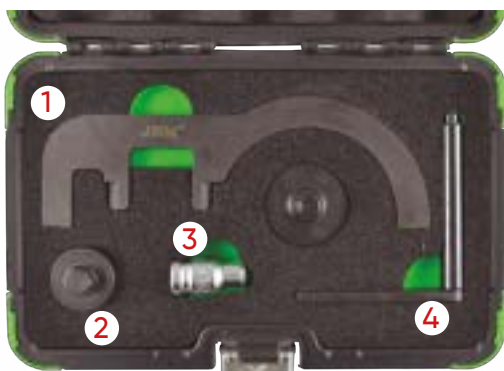

### MARCAS

BMW

BMW 1 SERIES: 116d E81/82/87/88 (08-12), 118d E81/82/87/88 (07-14), 120d E81/82/87/88 (07-14), 123d E81/82/87/88 (07-14).

BMW 2 SERIES: 218d (11-14), 220d (11-14), 225d (11-14).

BMW 3 SERIES: 316d E90/91/92/93 (09-12), 318d E90/91/92/93 (07-12), 320d E90/91/92/93 (07-12), 325d E90/91/92/93 (10-14), 330d/xd E90/91/92/93 (08-14).

BMW 5 SERIES: 520d E60/61 (07-10), 525d F10/11 (10-12), 530d F10/11 (10-13), 530dGT F07 (09-12), 535d F10/11 (10-17), 535dGT F07 (10-12).

BMW 7 SERIES: 730d/Ld F01/02/04 (08-12), 740d F01/02/04 (09-12), 740d xDrive F01/02/04 (09-12), 750d xDrive F01/02/04 (12-15).

BMW X SERIES: X1 sDrive 18d E84 (09-15), X1 sDrive 20d E84 (09-12), X1 xDrive 18d E84 (09-15), X1 xDrive 20d E84 (09-15), X1 xDrive 23d E84 (09-12), X3 2.0d E83 (07-10), X3 xDrive 18d E83 (08-10), X3 xDrive 30d E83 (11-12), X3 xDrive35d F25 (11-17), X5 3.0d E70 (10-13), X5 xDrive 40d X5 F15 M50d (13-17), E70 (10-13), X6 xDrive 30d E71/72 (10-14), X6 xDrive 40d E71/72 (10-14), X6 F16 M50d (14-17).

BMW MINI: Paceman (13-17), Countryman (10-17), Mini (10-15), Roadster (12-14), Clubman (10-14), Clubvan (12-14).

### FERRAMENTAS OEM

11.8.760 (1), 1.8.740 (2), 11.6.480 (3), 11.5.320 (4)

### CÓDIGOS DE MOTOR

1.6 D: N47; C16K1, C16U1.  
2.0 D: N47; C20U1N47; D20, D20A, D20B, D20D, D20K1, D20O0, D20O1, D20T1, D20U0, D20U1, N47S D20T0, N47T; D20, D20O1, D20U1.  
3.0 D: N57; B30B, B30B/T0, B30C, D30BT0, D30O0, D30O1, D30T0, D30T1, D30U0.



## KIT DE BLOQUEIO MERCEDES BENZ M271

53271

213,50€



diesel

gasolina

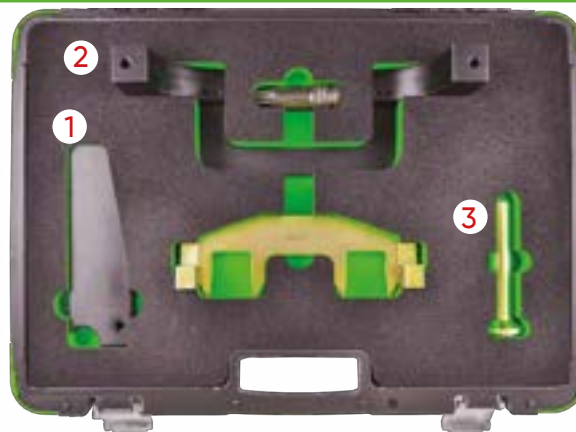

MARCAS	MERCEDES
FERRAMENTAS OEM	271 589 003100 (1), 271589014000 (2), 271589001500 (3)
CÓDIGOS DE MOTOR	M271. E18ML 2002. DE18ML 2003 - 2005. E16ML 2008. DE18LA 2009.

## KIT DE BLOQUEIO MERCEDES AMG 156

53272

172,50€



diesel

gasolina

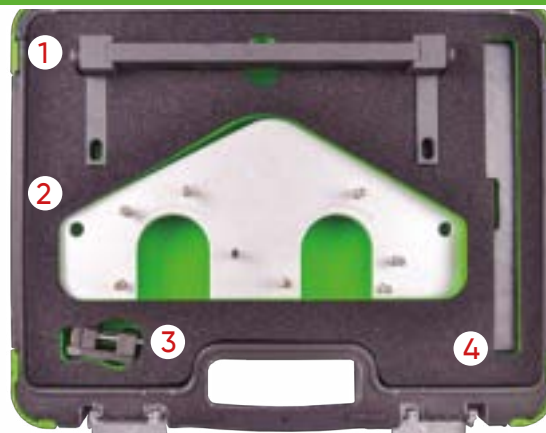

MARCAS	MERCEDES
FERRAMENTAS OEM	156 589 00 61 00 (1), 156 589 00 32 00 (2), 156 589 01 63 00 (3), 156 589 00 61 00 (3)
CÓDIGOS DE MOTOR	BENZ AMG 156.ML 63 AMG.S 63L AMG.S 63. AMG. R 63 AMG L 4MATIC. R63 AMG 4MATIC. E 63 AMG. CLS 63 AMG. CLK 63 AMG. CLK 63 AMG Black series. CLK 63 AMG Cabrio. CL 63 AMG.

## KIT DE BLOQUEIO MERCEDES M276 / M157 / M278

53273

68,00€

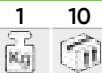

diesel

gasolina



MARCAS	MERCEDES		
FERRAMENTAS OEM	27658901400		
CÓDIGOS DE MOTOR	<table border="0"> <tr> <td>CL 500 / 63 AMG (C 216) 2010-2013. S 500 / 63 AMG (C 217) 2014. CLS 300 (C 218) 2012. E 300 / 350 / 400 (C/A 207) 2011. CLS 350 / 400 / 500 / 63 AMG (C/X 218) 2011-2014. SLK 350 (R 172) 2011. SL 350 / 400 / 500 / 63 AMG (R 231) 2012. S 500 PLUG-IN HYBRID (V 222) 2014. ML 300 / 350 / 500 / 63 AMG (W 166) 2011.</td> <td>C 400 (W 205) 2014. E 400 HYBRID (W 212) 2012. G 63 AMG (W 463) 2012. E 300 / 350 / 400 / 500 / 63 AMG (W/S 212) 2011. C 350 (W/S/C 204) 2011. S 350 / 500 / 63 AMG (W/V 221) 2010. S 400 / 63 AMG (W/V 222) 2013. R 350 BlueEFFICIENCY (W/V 251) 2012. GL 450 / 500 (X 166) 2012. GLK 350 (X 204) 2011.</td> </tr> </table>	CL 500 / 63 AMG (C 216) 2010-2013. S 500 / 63 AMG (C 217) 2014. CLS 300 (C 218) 2012. E 300 / 350 / 400 (C/A 207) 2011. CLS 350 / 400 / 500 / 63 AMG (C/X 218) 2011-2014. SLK 350 (R 172) 2011. SL 350 / 400 / 500 / 63 AMG (R 231) 2012. S 500 PLUG-IN HYBRID (V 222) 2014. ML 300 / 350 / 500 / 63 AMG (W 166) 2011.	C 400 (W 205) 2014. E 400 HYBRID (W 212) 2012. G 63 AMG (W 463) 2012. E 300 / 350 / 400 / 500 / 63 AMG (W/S 212) 2011. C 350 (W/S/C 204) 2011. S 350 / 500 / 63 AMG (W/V 221) 2010. S 400 / 63 AMG (W/V 222) 2013. R 350 BlueEFFICIENCY (W/V 251) 2012. GL 450 / 500 (X 166) 2012. GLK 350 (X 204) 2011.
CL 500 / 63 AMG (C 216) 2010-2013. S 500 / 63 AMG (C 217) 2014. CLS 300 (C 218) 2012. E 300 / 350 / 400 (C/A 207) 2011. CLS 350 / 400 / 500 / 63 AMG (C/X 218) 2011-2014. SLK 350 (R 172) 2011. SL 350 / 400 / 500 / 63 AMG (R 231) 2012. S 500 PLUG-IN HYBRID (V 222) 2014. ML 300 / 350 / 500 / 63 AMG (W 166) 2011.	C 400 (W 205) 2014. E 400 HYBRID (W 212) 2012. G 63 AMG (W 463) 2012. E 300 / 350 / 400 / 500 / 63 AMG (W/S 212) 2011. C 350 (W/S/C 204) 2011. S 350 / 500 / 63 AMG (W/V 221) 2010. S 400 / 63 AMG (W/V 222) 2013. R 350 BlueEFFICIENCY (W/V 251) 2012. GL 450 / 500 (X 166) 2012. GLK 350 (X 204) 2011.		

## KIT DE BLOQUEIO MERCEDES / CHRYSLER / JEEP

53270

63,50€

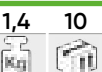

diesel

gasolina

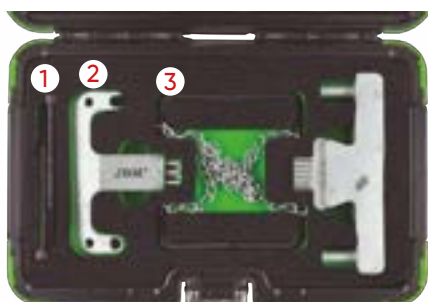

MARCAS	MERCEDES CHRYSLER JEEP
FERRAMENTAS OEM	112 589 03 40 00 (1), 601 589 02 40 00 (2), 111 589 03 15 00 (3)
CÓDIGOS DE MOTOR	Herr.: 112 589 03 40 00: 112, 113, 137, 155, 156, 272/979, 273, 629, 642/992. Herr.: 601 589 02 40 00: 102, 103, 104, 111, 601, 602.91/93/94/96/983, 603.91/93/96/97, 604, 605, 606, 611, 612/965/966, 613. Herr.: 111 589 03 15 00: 111, 119, 604, 605, 606, 611/980, 612, 613, 628, 629, 640, 642/922, 612.965/966, 646, 647, 648.



## KIT DE BLOQUEIO DE DISTRIBUIÇÃO PARA VAG 1.2/1.4 TSI

53648

3,70 2 40

gasolina

106,50€

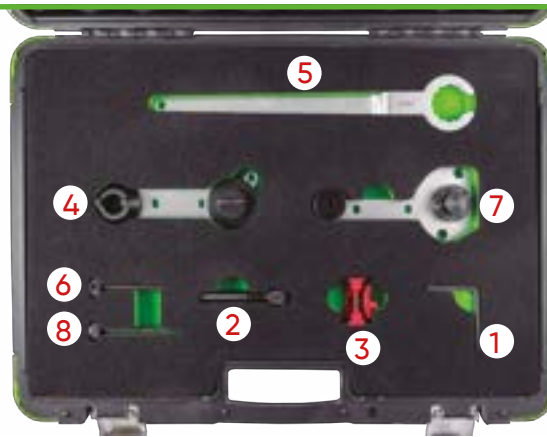

<b>MARCAS</b>	AUDI: A1 (12-15), A1 Sportback (12-15), A3 (13-15), A3 Sportback (12-15). SEAT: Ibiza (12-15), Leon (12-15), Toledo (12-15). SKODA: Fabia (10-13), Octavia II (10-13), Octavia III (10-15).
<b>FERRAMENTAS OEM</b>	T10060A (1), T10340 (2), T10476 (3), T10494 (4), T10499 (5), T10504/1 (6), T10504 (7), T10504/2 (8).
<b>CÓDIGOS DE MOTOR</b>	1.2 TSI: CJZA, CJZB. 1.4 TSI: CGGA, CHPA, CMBA, CPVA, CRJA, CXSA. 1.4 TSI ACT: CPTA.

## KIT DE ALINHAMENTO DO EIXO DE COMANDO VAG 1.4/1.6/2.0 TDI COM O SISTEMA COMMON RAIL

53706

1,5 5

diesel

88,00€



<b>MARCAS</b>	VOLKSWAGEN: Golf Alltrack, Golf Sportsvan, Golf VII, Golf VII Kombi, Passat, Polo. AUDI: A1, A1 Sportback, A3, A3 Cabriolet, A3 Limousine, A3 Sportback, TT, TT Roadster. SEAT: Ibiza, Ibiza V Sportcoupe, Ibiza V ST, Leon, Leon SC, Leon ST, Toledo IV. SKODA: Fabia, Fabia Kombi, Octavia, Octavia Combi, Rapid, Rapid Spaceback.
<b>FERRAMENTAS OEM</b>	OEM 3204 (1), OEM 3359 (2), OEM T10490 (3), OEM T10051 (4), OEM T10060A (5), OEM T10264 (6), OEM T10265 (7), OEM T10492 (8), OEM T40098 (9).
<b>CÓDIGOS DE MOTOR</b>	1.4, 1.6, 2.0 TDI CR CXXB, DBKA, DCXA, CGLE, CKFB, CKFC, CLHA, CLHB, CNHA, CNHC, CRBD, CRFA, CRFC, CRKA, CRKB, CRLB, CRLC, CRMB, CRUA, CRVA, CRVC, CSUA, CSUB, CUNA, CUPA, CUSA, CUSB, CUTA, CUUD, CXEB, DBKA, DCXA, DCZA, DFSD.

## KIT DE ALINHAMENTO EIXO DE COMANDO VW / AUDI

53280

3,5 5 165

gasolina

102,50€

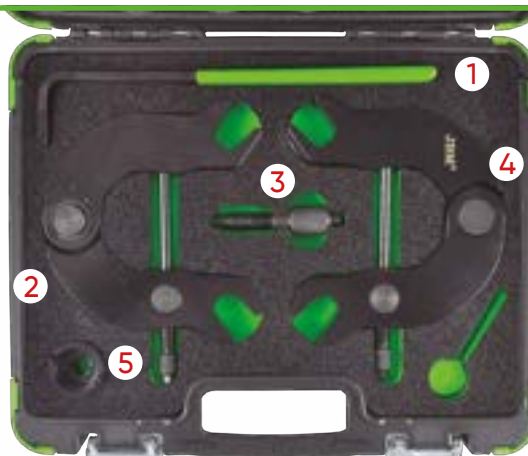

<b>MARCAS</b>	AUDI: A4 (01-08), A6 (01-08), A8 (03-10).
<b>FERRAMENTAS OEM</b>	3387 (1), T40030 (2) (4), T40026 (3), T40028 (5)
<b>CÓDIGOS DE MOTOR</b>	3.0 V6 30v: ASN, AVK, BBJ, BGN.

## KIT DE BLOQUEIO AUDI V6 2.0 / 2.8 / 3.0 TFSI

53278

4,75 2 40

gasolina

141,50€

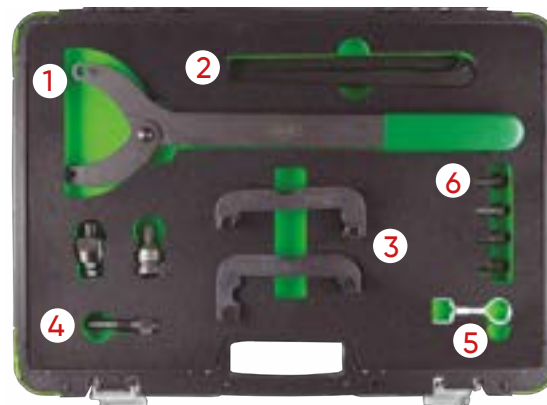

<b>MARCAS</b>	AUDI: Q5, V6 2.0, 2.8, 3.0T FSI SEAT: Ibiza/Cordoba, Toledo, Alhambra, Inca 1.6, 1.8, 1.8 16v, 2.0, 2.0 16v, Ibiza/Cordoba, Leon, Toledo 1.6 (99-), Alhambra 2.0 (00-). VOLKSWAGEN: V6 2.0, 2.8, 3.0T FSI. AUDI/VOLKSWAGEN: V6 2.0, 2.8, 3.0T FSI. AUDI Q5: 2.0, A6L 2.8, 3.0T.
<b>FERRAMENTAS OEM</b>	T10172 (1), 3212 (2), T40070 (3), T40069 (4), T40071 (5), T10172/2 (6)
<b>CÓDIGOS DE MOTOR</b>	2.0, 2.8, 3.0

## KIT DE FERRAMENTAS PARA CORREIA DE DISTRIBUIÇÃO **BMW / AUDI**

**53277**

45,00€

1,6

5

165



**diesel**

**gasolina**

**MARCAS**

**GASOLINA**

**AUDI:** 80, 100, A3, A4, A6 1.6, 1.8/Turbo, 2.0, 2.0 16v, A3, A4 1.6 (96-).  
**SEAT:** Ibiza/Cordoba, Toledo, Alhambra, Inca 1.6, 1.8, 1.8 16v, 2.0, 2.0 16v, Ibiza/Cordoba, Leon, Toledo 1.6 (99-), Alhambra 2.0 (00-).  
**VOLKSWAGEN:** Polo Classic, Scirocco, Corrado, Golf, Jetta, Vento, Passat, Sharan, Transporter 1.6, 1.8/Turbo, 1.8 16v, 2.0, 2.0 16v, Polo Classic, Golf, Bora, Beetle 1.6 (97-), 2.0 (99-).  
**SKODA:** Octavia 1.6 (97-), 2.0 (99-).

**DIESEL**

**AUDI:** 80, 100, A3, A4, A6 1.9 Turbo D, 1.9TDi, 2.5TDi, A3, A4, A6 2.0TDi, A2, A3, A4, A6 1.2TDi, 1.4TDi, 1.9TDi (99-).  
**SEAT:** Ibiza/Cordoba, Leon, Toledo, Alhambra, Inca 1.7SDi, 1.9D/TD /Sdi/Tdi.  
**FORD:** Galaxy (02-06).  
**SKODA:** Felicia, Octavia 1.9D/Tdi.  
**VW:** Polo, Polo Classic, Golf, Jetta, Vento, Bora, Beetle, Passat, Sharan, Caddy, Transporter 1.5D, 1.6D/Turbo, 1.7D/Sdi, 1.9Sdi/Tdi, Golf, Passat 2.0TDi.

**FERRAMENTAS OEM**

T10020 (1), 3387 (2), V159 (3), T10060/T100604 (4), T10115 (5), T40011 (6)

**CÓDIGOS DE MOTOR**

2.0, 2.8, 3.0

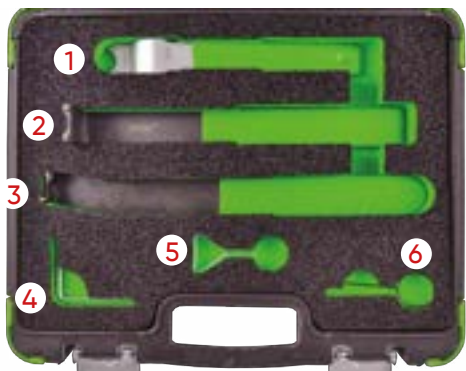

## KIT DE BLOQUEIO **AUDI / SKODA**

**53276**

156,00€

5,3

2

40



**diesel**

**gasolina**

**MARCAS**

**MOTORES AUDI/VW:** V6 2.0, 2.8, 3.0T FSI.  
**AUDI/Q5:** 2.0, A6L 2.8, 3.0T.

**FERRAMENTAS OEM**

T0016 (1), T10123 (2) (3), T10098A (5), T10264 (7), T10265 (8), 3369 (12), T10120 (13), T10008 (15), T10060/T10060A (18), 2064 (19), T20102/3359 (21), T10050 (22) T10100 (23), 3458 (26)

**CÓDIGOS DE MOTOR**

2.0, 2.8, 3.0

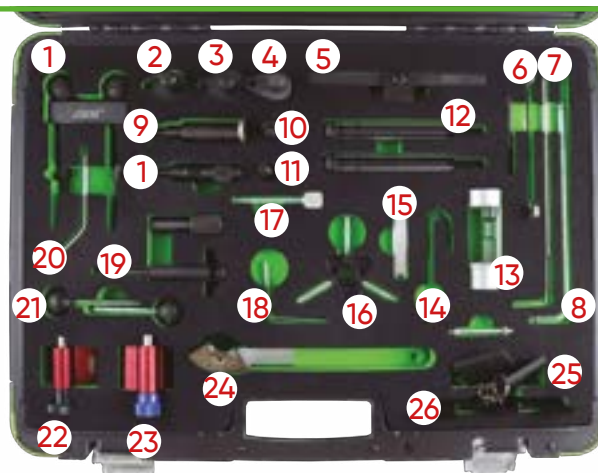

## KIT DE ALINHAMENTO EIXO DE COMANDO **VW / AUDI**

**53281**

53,50€

1,3

5

**diesel**

**MARCAS**

**VOLKSWAGEN:** 2.5 TDi V6 DIESEL  
**AUDI:** A4, A6, A8

**FERRAMENTAS OEM**

3369 (1), 3242 (2), 3458 (3)

**CÓDIGOS DE MOTOR**

AFB/AKN



## KIT DE BLOQUEIO **VW / AUDI**

**53282**

48,00€

1,75

5

135



**gasolina**

**MARCAS**

**SEAT:** Alhambra (10-15), Altea/Altea XL (08-15), Ibiza/Cordoba (08-12), Leon (07-13), Toledo (07-15).  
**VOLKSWAGEN:** Beetle (11-15), Caddy/Caddy Maxi (10-15), EOS (06-12), Golf (03-12), Golf Plus (03-14), Golf V Estate (07-13), Golf VI Cabriolet (10-15), Jetta (06-14), Passat (05-11), Polo (02-14), Scirocco (08-12), Tiguan (07-12), Touran (03-15).  
**SKODA:** Fabia II (07-15), Octavia II (04-15), Praktik (10-15), Rapid (12-15), Roomster (06-15), Superb II (09-14), Yeti (09-14).  
**AUDI:** A1 (10-15), A3 (03-13).

**FERRAMENTAS OEM**

T10171 (1), T10170 (2), T40011 (3)

**CÓDIGOS DE MOTOR**

1.2 TFSi: CBZA, CBZB, CBZC.  
 1.4 FSI: AXU, BKG, BLN.  
 1.4 TFSi: BLG, BMY, BWK, CAVA, CAVB, CAVC, CAVD, CAVE, CAVF, CAXA, CAXC, CDGA, CSMA.  
 1.6 FSI: BAG, BLF, BLP, BTS.





## KIT DE BLOQUEIO VW / AUDI 2.0TFSI

**53279**  
90,00€

2,1 5 135

gasolina



### MARCAS

AUDI: A3 (96-09), A4 (94-09), A6 (95-11), S3 (99-13), TT (98-14).  
SEAT: Alhambra (97-10), Altea/Altea XL (06-09), Cordoba (99-02), Exeo (09-10), Ibiza (99-02), Leon (99-13), Toledo (99-09).  
SKODA: Octavia/Octavia Tour (98-10), Octavia II (04-09).  
VOLKSWAGEN: Beetle (99-11), Bora (97-04), Eos (06-10), Golf Plus (05-09), Jetta (05-09), Passat (96-10), Scirocco (09-14), Sharan (97-10), Touran (03-09).

### FERRAMENTAS OEM

T10020 (1), T10252 (2), T10092 (3), T10115 (4), T40011 (4), 3366 (5), T10060 (6)

### CÓDIGOS DE MOTOR

1.8: ADR, AFY, AGN, AJP, APG, APT, AQE, ARG, ARH, AVV.  
1.8T: AEB, AGU, AJH, AJL, AJQ, AMK, AMU, ANB, APP, APU, APX, APY, AQA, AQX, ARX, ARY, ARZ, AUM, AUQ, AVC, AWC, AWT, AWU, AYP, BAM, BFV, BVP, BVY.  
2.0 TFSI: AXW, BHD, BLR, BLX, BLY, BMB, BVX, BVY, BVZ.  
2.0 TFSI/S/R/Tsi: AXX, BPY, BWA, BGB, BPG, BPJ, BUL, BWE, BWI, BYK, BHZ, BZC, BWJ, BYD, CDLA, CDLB, CDLC, CDLD, CDF, CDMA.

## KIT DE BLOQUEIO VOLKSWAGEN / SEAT / SKODA 1.2L

**53274**  
30,50€

1,05 5 10

gasolina

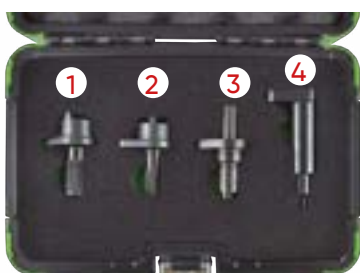

### MARCAS

VOLKSWAGEN  
1.2: Lupo / Polo / Eos / Fox.  
SEAT  
1.2: Ibiza / Cordoba  
SKODA  
1.2: Fabia

### FERRAMENTAS OEM

T10123 (1) (2), T10120 (3), T10121 (4)

### CÓDIGOS DE MOTOR

AWY / BMD / AZQ / BME.

## KIT DE BLOQUEIO VW / AUDI

**53326**  
13,50€

0,3 10 40

diesel



### MARCAS

VW: V6 2.5TDi.  
AUDI: V6 2.5TDi, V8 3.3TDi.

### FERRAMENTAS OEM

3458 (1), T40069 (2)

## KIT DE BLOQUEIO VW 1.2L

**53327**  
11,00€

0,2  
10  
60

gasolina



### MARCAS

SEAT: Ibiza 1.2 6v/3cyl (2002-09), Cordoba 1.2 12v/3cyl (2002-13).  
VW: Polo 1.2 6v-12v/3cyl (2002-14).  
SKODA: Fabia 1.2 6v-12v/3cyl (2002, 2003-), Fabia II 1.2 6v/3cyl (2007-13), Roomster 1.2 12v/3cyl (2006-13), Praktik 1.2 6v/3cyl (2007-13).

### FERRAMENTAS OEM

T10123.

### CÓDIGOS DE MOTOR

1.2 6v: AWY, BMD, BBM, CHFA, CHFB  
1.2 12v: AZQ, BME, BXV, BZG, CEVA, CGPA, CGPB.

## KIT DE BLOQUEIO VAG 2.7 / 3.0 TDI

**53283**  
92,00€

2,1 5

diesel



### MARCAS

VOLKSWAGEN: Touareg, Phateon  
VAG: Diesel 2.7 / 3.0 V6  
AUDI: A4, A5, A6

### FERRAMENTAS OEM

3242 (1), T40060 (2) (3), 3359 (4), T40058 (5), T40061 (6), T40062 (7), T40049 (8)

### CÓDIGOS DE MOTOR

ASB, BKN, BKS, BWZ, BNG, BPP, BSG, BUG, BUN, CAWA, CAMB, CANA, CANB, CANC, CAND, CAPA, CARA, CARB, CASA, CASE, CASC, CAM, CC/HA, CCWA, CCWB, CDYA, CDVB, CDVC, CEXA, CGKA, CGKB.

## KIT DE BLOQUEIO VAG 2.5 / 4.9D / TDI

53284

285,00€



diesel

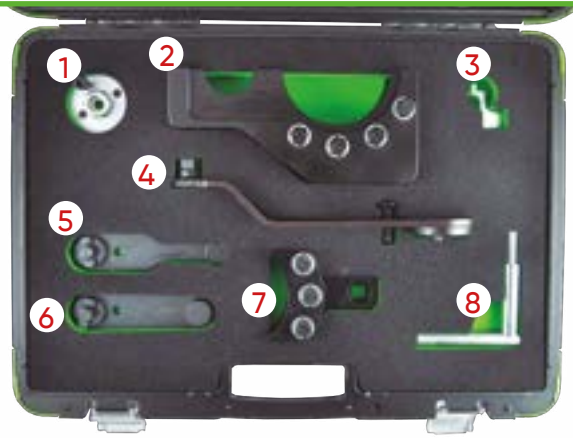

MARCAS	VOLKSWAGEN: Touareg (03-10), Transporter (03-09).
FERRAMENTAS OEM	T10225 (1), T10199 (2), T10234 (3), T10226 (4), T10193 (5), T10194 (6), T10199/01 (7), T10226 (8)
CÓDIGOS DE MOTOR	2.5D TDi PD: AXD, AXE, BAC, BLJ, BLK, BNZ, BPC, BPD, BPE.

## KIT DE BLOQUEIO VAG 2.4 / 2.5D SDI

53285

56,00€



diesel



MARCAS	VOLKSWAGEN: Crafter (06-13), LT (96-06), Transporter (90-03).
FERRAMENTAS OEM	2065A (1), T50009 (2), T10025 (3), 3248/3419 (4), 2064 (5), 3355 (6)
CÓDIGOS DE MOTOR	2.4D: AAB, AJA. 2.5D SDI: AGX. 2.5D Tdi: ACV, AHD, AHY, AJT, ANJ, APA, AUF, AVR, AXG, AXL, AYC, AYY, BBE, BBF. 2.5D TDiCR: BJJ, BJK, BJL, BJM.

## KIT DE BLOQUEIO VAG 1.8 / 2.0TSI

53286

87,00€



gasolina

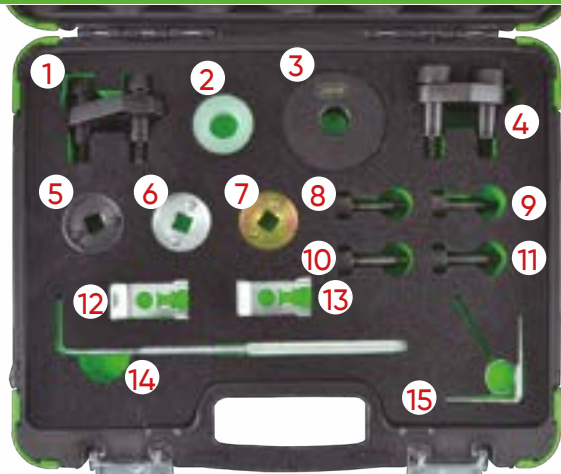

MARCAS	VOLKSWAGEN: 1.8 / 2.0 TSI / TFSI.
FERRAMENTAS OEM	T10368 (2), T10354 (3), T40271 (4), T10352/2 (5), T10352/1 (6), T10352 (7), T40196 (8) (9) (10) (11), T40267 (12) (13), T40098 (14), T10060A (15), T40011 (15)
CÓDIGOS DE MOTOR	BYT, BZB, CABA, CABB, CABD, CADA, CAEA, CAEB, CAWA, CAWB, CBFA, CCTA, CCZA, CCZB, CCZC, CDA, CDAB, CDHA, CDHB, CDNB, CDNC, CDND, CESA, CETA, CFKA, CGYA, CJEB, CJBA, CJSB.

## KIT DE BLOQUEIO VW / AUDI 1.8 / 2.0L TURBO

53287

228,50€



gasolina

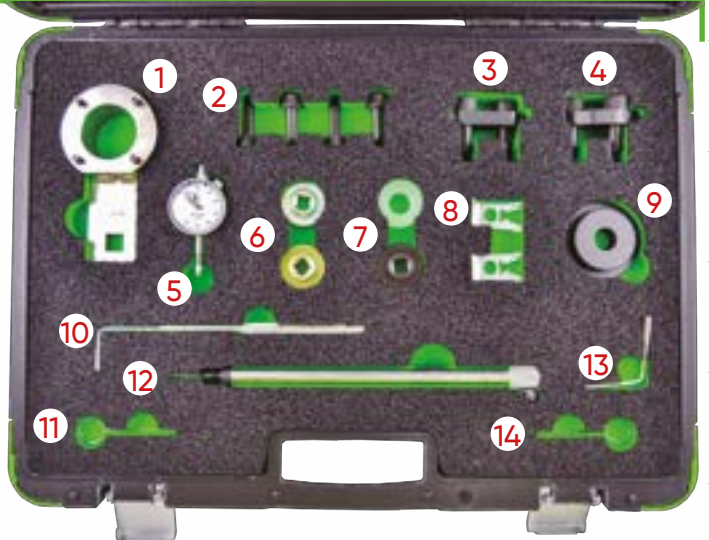

MARCAS	VOLKSWAGEN AUDI	1.8 / 2.0 TURBO
FERRAMENTAS OEM	T10355 (1), T40196 (2), T40271 (3) (4), T10352 (5), T10352/1 (6), T10352/2 (7), T10368 (7), T40267 (8), T10354 (9), T40265 (10), T40011 (11) (14), T40098 (12), T10060A (13)	
CÓDIGOS DE MOTOR	BYT, BZB, CABB, CABD, CADA, CAEA, CAEB, CAWA, CAWB, CBFA, CCTA, CCZA, CCZB, CCZC, CDA, CDAB, CDHB, CDNB, CDNC, CDND, CESA, CETA, CFKA, CGYA, CJEB, CJS, CJSB.	



## KIT DE BLOQUEIO VAG 1.6 / 2.0L TDi PD COMMON RAIL

53288

72,00€

2,15

5

diesel



### MARCAS

SEAT: Exeo, Leon, Altea, Toledo, Ibiza.  
VOLKSWAGEN: Jetta, Touran, Golf, Golf Plus, Polo, Passat, Tiguan, Scirocco.  
SKODA: Roomster, Fabia, Praktik, Octavia, Yeti, Superb.  
AUDI: A1, A3, A4, A5, Q5, A6, TT.

### FERRAMENTAS OEM

T10264 (1), T10265 (2), T20102 (3), T10052 (4), T10051 (5), T10255 (6), T10050 (7), T10100 (8), T40098 (9)

### CÓDIGOS DE MOTOR

1.2 TDI CR, 1.6 D TDI CR, 2.0 D TDI CR

CAGA, CAGB, CAGC, CAHA, CAHB, CFHC, CBAA, CBAB, CFFB, CGLA, CGLB, CJCA, CJCB, CAAA, CBAA, CBAB, CBAC, CBBA, CBBB, CBDA, CBDB, CBDC, CCHA, CEGA, CJAA, CAAB, CAAC, CFJA, CFWA, CAYB, CAYC, CAYA.

## KIT BLOQUEIO DE DISTRIBUIÇÃO PARA AUDI / VW / SEAT / SKODA

53649

112,60€

3,53

2

42

gasolina

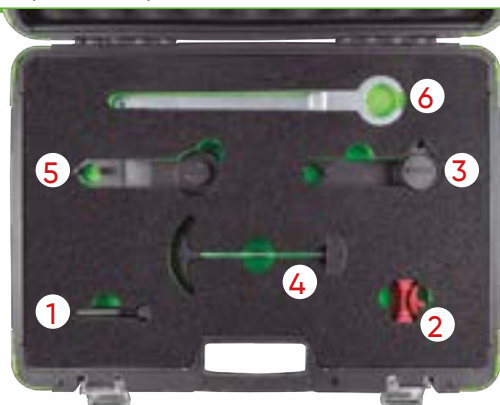

### MARCAS

AUDI SEAT SKODA VW

### FERRAMENTAS OEM

T10340 (1), T10476 (2), T10477 (3), T10487 (4), T10494 (5), T10499 (6)

### CÓDIGOS DE MOTOR

1.0 MPI: CHYA.  
1.0 TSI: CHZE, CHZC, CHZA, CHZB, CHZC, CHZD, CHZJ.  
1.2 TSI: CJZB, CJZC, CYVA, CJZA, CJZD, CYVB.  
1.4 TSI: CZCC, CMBA, CZCA, CHPA, CPTA (ACT), CZDA, CVNA, CZEA (ACT).

## KIT DE BLOQUEIO VW / AUDI

53275

35,50€

0,7

5

10

330

diesel

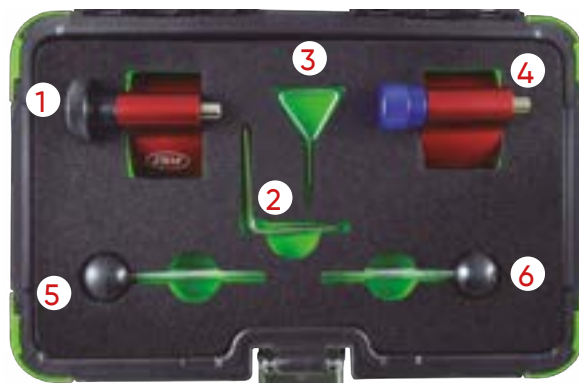

### MARCAS

DODGE: Caliber (06-11)  
FORD: Galaxy (02-06)  
MITSUBISHI: Grandis (05-10), Lancer (05-10), Outlander (07-10).  
SEAT: Alhambra (00-15), Altea/Altea XL (04-15), Cordoba (02-09), Ibiza (02-15), Leon (00-13), Toledo (04-11).  
SKODA: Fabia (00-14), Fabia II (07-15), Octavia (00-10), Octavia II (04-15), Praktik (10-15), Rapid (11-15), Roomster (07-15), Superb (02-08), Superb II (08-15), Yeti (09-14).  
AUDI: A1 (10-15), A2 (00-06), A3 (01-13), A4/Allroad (01-16), A5 (08-15), A6 (11-14), TT (08-14), Q3 (11-15), Q5 (08-15), A6 (10-14).  
VOLKSWAGEN: Amarok (10-16), Beetle (02-15), Bora (02-08), Caddy/Maxi (03-15), EOS (06-15), Fox (05-11), Golf (02-15), Golf Plus (05-14), Jetta (05-15), Lupo (02-05), Passat/CC (02-15), Polo (99-14), Scirocco (08-14), Sharan (02-15), Tiguan (07-15), Touran (03-15), Transporter (03-17).

### FERRAMENTAS OEM

DODGE: 9882, 9883.  
FORD: 310-085/23-059, 303-1054.  
MITSUBISHI: MB995206, MB995209.  
VAG: T10100 (4), T10050 (1), 3359 (3/6)/T20102, T10115 (3), T10060A (2)/T40098, T20167.

### CÓDIGOS DE MOTOR

1.2D TDI CR: CFWA.  
1.4D TDI PD: AMF, BAY, BMS, BNM, BNV, BWB.  
1.6D TDI CR: CAYA, CAYB, CAYC, CAYD, CAYE, CLNA.  
1.9D TDI PD: AJM, ANU, ARL, ASZ, ATD, AUY, AVB, AVF, AVQ, AWX, AXB, AXC, AXR, BJB, BKC, BLS, BLT, BMT, BPZ, BRM, BRR, BRS, BRU, BSU, BSV, BSW, BDJ, BDK, BEW, BGW, BHW, BKD, BKP, BKQ, BLB, BMA, BMM, BMN, BMP, BMR, BNA, BPW, BRA, BRC, BRD, BRE, BRF, BRT, BSS, BST, BSY, BUY, BUZ, BVA, BVE, BVF, BVG, BVH, BWC, BWV, CAAA, CAAB, CAAC, CAAD, CAAE, CAGA, CAGB, CAGC, CAHA, CAHB, CBAA, CBAB, CBAC, CBBA, CBBB, CBDA, CBDB, CBDC, CBEA, CCHA, CCHB, CDBA, CDCA, CEGA, CFCA, CFFA, CFFB, CFFD, CFFE, CFGB, CFGC, CFHA, CFHB, CFHC, CFHD, CFHE, CFHF, CFJA, CGLA, CGLB, CGLC, CGLD, CJAA, CJCA, CJCB, CJCC, CLCA, CLCB, CLJA, CLLA, CNEA, ECD, ECD/BSY, ECD/BYL, ECE/BWD.

## KIT BLOQUEIO DE DISTRIBUIÇÃO PARA SEAT / VW / AUDI / SKODA

51943

199,50€

5,13

2

64

### MARCAS

AUDI: 80, 100, A2, A3, A4, A6, TT  
SEAT: Terra, Ibiza, Córdoba, Leon, Toledo, Inca, Alhambra  
SKODA: Fabia, Felicia y Octavia.  
VW: Lupo, Polo/Classic, Caddy, Golf, Jetta, Vento, Bora, New Beetle, Passat, Sharan, Transporter y LT

### FERRAMENTAS OEM

3418/2065A (1), 3411 (2), 3458 (3), T40069 (4), 2064/U20003 (5), T10050 (6), 3359 (7), T10008 (8), 3387 (9), 2065A (10), 3418 (11), 3369 (12), T10016/ T10074 (13), T40011 (14), T20038/MPI-312&T10098 (15), T10123 (16), T10121 (17), T10120 (18), T10115 (19), M5x55mm (20), T10004 (21), T10020 (22), T10252 (23), 3366 (24), T10060/T10060A (25), T10092 (26), T40026 (27), 3268 (28), T40011 (29)

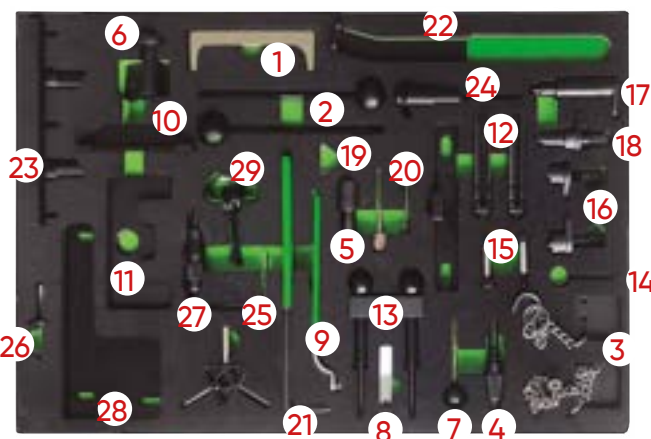



## KIT DE BLOQUEIO RENAULT 1.4 / 1.6 / 1.8 / 2.0 16V

53289

45,00€



gasolina

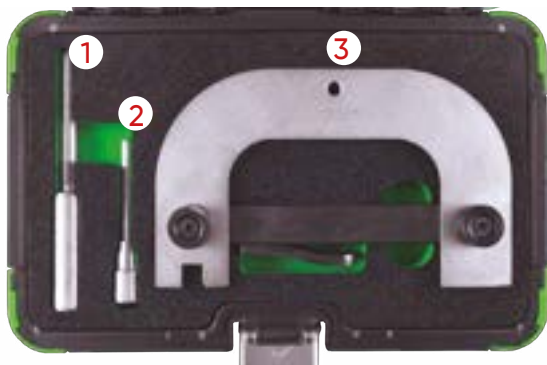

### MARCAS

**RENAULT:** Espace/Grand Espace (98-02), Espace/Grand Espace IV (02-10), Kangoo/Trekka (01-09), Laguna (98-01), Laguna II (01-07), Laguna III (07-13), Megane (99-03), Megane II (02-10), Megane III/Sport (08-13), Megane/Scenic (99-00), Scenic/RX4 (99-03), Scenic/Grand Scenic II (03-09), Trafic II (01-11), Twingo II (08-14), Vel Satis (00-10), Wind (10-14)  
**DACIA:** Logan/MCV (05-11).  
**NISSAN:** Kubistar X76 (03-09), Primastar (02-11).  
**VAUXHALL/OPEL:** Jetta, Touran, Golf, Golf Plus, Polo, Passat, Tiguan, Scirocco.

### FERRAMENTAS OEM

Mot1489 (1), Mot1054 (2), Mot1496 (3)

### CÓDIGOS DE MOTOR

1.4 16v K4J: 730, 732, 740.  
 1.6 16v K4M: 752, 753, 760, 761, 764, 788, 812, 813, 854, 856.  
 1.8 16v F4P: 720, 722, 760, 770, 771, 772, 773, 774, 775.  
 2.0 16v F4R: 700, 701, 712, 713, 714, 715, 720, 722, 730, 732, 736, 738, 740, 741, 744, 746, 747, 762, 763, 764, 765, 766, 767, 770, 771, 780, 790, 791, 792, 820, 830, 832, 867.  
 2.0 16v F4R(t): 720, 722, 764, 765, 774, 776, 784, 786, 787, 794, 795, 796, 797, 800, 802, 810, 811, 870, 872, 874, 886, 887, 896, 897.

## KIT DE BLOQUEIO RENAULT

53291

68,00€



gasolina

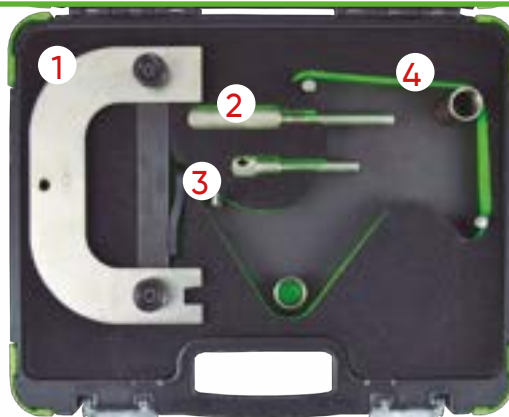

### MARCAS

**RENAULT:** Clio, Laguna, Megane

### FERRAMENTAS OEM

MOT1496 (1), MOT1489 (2), MOT861/1863 (3), MOT1490 (4)

### CÓDIGOS DE MOTOR

K4J, K4M, F4P, F4R.

## KIT DE BLOQUEIO RENAULT / VOLVO 16V / 20V

53290

51,00€



gasolina



### MARCAS

**RENAULT:** Laguna 2.0 16V / 2.5 20V (1996-1999), Safrane 2.0 16V / 2.5 20V (1996-2001)  
**VOLVO:** 850 (1992-1997), C70 (1998-2002), S40 (1996-2004), V40 (1996-2004), S60 (2001-2005), S70 (1997-2000), S80 (1999-2005).

### FERRAMENTAS OEM

MOT1348 (1), MOT1337 (2), MOT1340 (3)

### CÓDIGOS DE MOTOR

**RENAULT:** N7Q 704/710/711(2.0 16V), N7U 700/701(2.5 20V).  
**VOLVO:** B4164S, B4164S2, B4184S, B4184S2, B4184S3, B4184S9, B4184S10, B4194T, BS194T2, B420S4, B4204S2, B4204T, B4204T2, B4204T3, B4204T5, B5202Fs, B5204FT, B5204T2, B5204T3, B5204T4, B5204T5, B5234FS, B5204FT, B5234T3, B5234T4, B5234T5, B5234T6, B5234T7, B5234T8, B5234T9, B5244S, B5244S2, B5244SG, B5244SG2, B5244T, B5244T3, B5244T4, B5244T5, B5244T7.

## CONJUNTO DE BLOQUEIO DE MOTORES A DIESEL RENAULT / NISSAN 1.6 DCI

53523

89,60€



diesel



### MARCAS

**RENAULT:** Espace/Grand Espace IV (06-10), Kaleos (08-11), Laguna II (05-07), Laguna III (07-12), Master III (10-12), Magane II (06-10), Scenic/Grand Scenic II (06-09), Scenic/Grand Scenic III (09-12), Trafic II (06-12), Vel Satis (05-10)  
**NISSAN:** Primastar X83 (06-10), Qashqai/Qashqai+2 J10 (07-10), X-Trail T31 (07-12).  
**VAUXHALL / OPEL:** Movano-B (10-12), Vivaro (06-12).

### FERRAMENTAS OEM

MOT1969 (1), MOT1970 (2), MOT1770, MOT1773, EN-48330, EN-48332, EN-48334, EN-48831, KM-6130

### CÓDIGOS DE MOTOR

M9R 2.0dCi: 610, 615, 630, 700, 721, 740, 742, 760, 761, 762, 763, 780, 782, 784, 786, 788, 800, 802, 803, 805, 808, 816, 830, 832, 833.  
 M9T 2.3dCi: 670, 672, 676, 678, 680, 686, 690, 692, 694, 698.

## KIT DE BLOQUEIO RENAULT / NISSAN / OPEL / VOLVO

53769

170,00€

5,90

3

36

diesel

gasolina

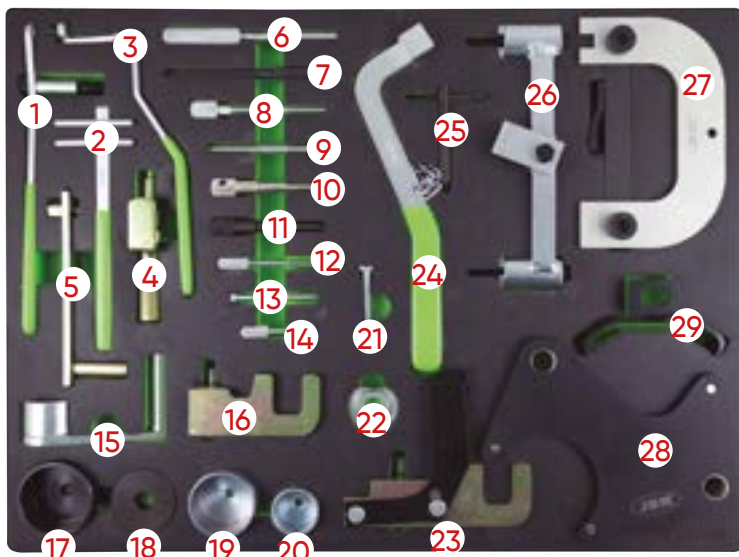

<b>MARCAS</b>	<p><b>RENAULT:</b> Avantime, Clio, Espace, Kangoo, Laguna, Master, Megane, Modus, Scenic, Twingo, Traffic.  <b>OPEL/VAUXHALL:</b> Movano, Vivaro.  <b>DACIA:</b> Dokker, Duster, Logan, Sandero.  <b>NISSAN:</b> Almera, Interstar, Kubistar, Micra, Note, Primera, Qashqai.  <b>VOLVO:</b> S40, V40</p>
<b>FERRAMENTAS OEM</b>	<p>MOT 1312 (1), MOT 1135-01 (2), MOT 1384 (3), MOT 1340 (4), MOT 1543 / KM-6234 / KV113 B0360 (5), MOT 1489 / KV113 B0130 (6), MOT 1536 / KM-6203 (7), MOT 1489 (8), MOT 1054 / KM-6031 / KV113 / B0280 (10), MOT 1318 (11), MOT 910 (12), MOT 910 (14), MOT 1386 (15), MOT 1534 / KM-6205 (16), MOT 1543 / KM-6234 / KV113 B0360 (17), MOT 1543 / KM-6234 / KV113 B0360 (18), MOT 1543 / KM-6234 / KV113 B0360 (19), MOT 1543 / KM-6234 / KV113 B0360 (20), MOT 1386 (22), MOT 1537 / KM-6204 (23), MOT 1348 (24), MOT 1538 (25), MOT 1337 (26), MOT 1496 / MOT 1750 (27), MOT 1490-01 (28), MOT 1200-01 (29)</p>
<b>CÓDIGOS DE MOTOR</b>	<p><b>GASOLINA:</b> 2.0 16V, 2.5 20V, 1.4, 1.6 16V, 1.8, 2.0 16V, 1.2, 1.7, 1.8, 2.0 16V, 2.2  <b>DIESEL:</b> 1.9, 2.5, 2.8</p> <p>D4F702/706/708/712/714/716/722/728/730/740/764, D7F700/701/710/720/722/726/730/744/746/764/766, E7F700/704/706/750, E7J601/624/626/634/635/680/700/706/710/711/716/718/719/720/724/726/728/740/742/745/754/756/757/764/770/771/773/780, F3P670/682/700/704/706/708/710/712/714/720/724/755/758/760, F7P704/722, F3R611/722/723/728/729/750/751/752/791/796/797/798, F5R700/701/740, J7R732/733/734/735/768, F7R710/714, J7T600/760/761/762/766/772/780/782, N7Q704/710/711, N7U700/701, K4J700/710/711/712/713/714/715/730/732/740/750/770/780, K4M700/701/704/706/707/708/709/710/711/712/714/716/718/720/724/730/732/734/736/740/742/743/744/745/746/748/750/752/753/754/760/761/762/764/765/766/768/776/782/788/790/791/794/800/801/802/804/812/813/830, K9K700/702/704/706/710/712/714/716/718/722/724/728/729/732/734/740/750/752/760/762/764/766/768/802/804/806, F9Q610/650/664/670/674/71/716/717/718/720/722/730/731/732/733/734/736/738/740/744/748/750/752/754/758/759/760/768/762/770/772/774/780/782/784/786/788/790/796/800/803/804/808/812/816/818/820, C9T600/605/700/702/703/706/707/710/712/720/722/742/743/750, G9U720/724/726/730/750/754, F8M736/760, F8Q600/610/606/620/622/624/630/632/640/644/646/648/662/672/678/680/682/684/692/696/706/714/720/722/730/732/740/742/744/764/768/770/6/776/784/786/788, J8S620/621/622/758/760/776/778, G8T714/716/740/752/760/790/792/794, S8U720/722/730/731/742/748/750/752/770/772/780/782, S9U700/702/704/714/740, S9W700/702/206/208/212, E5F, E6J, K7M, F4P/F4R, F1N, F2N, F3N, F2R, F3P, F4P, F3R, J5T, J6R, J7R</p>

## KIT DE BLOQUEIO RENAULT / OPEL 2.2 / 2.5 TDI DCI

53292

116,00€

2,35

5

165

gasolina



<b>MARCAS</b>	<p><b>RENAULT:</b> Laguna II, Espace, Master, Traffic, 2.2 / 2.5 DCI  <b>OPEL:</b> Vivaro, Movano, DIESEL: 2.2 / 2.5 DTI, Astra B, Vectra B, Signum, Zafira, 2.2 16V</p>
<b>FERRAMENTAS OEM</b>	<p>KM6205 (1), KM6204 (2), KM6077 (3)</p>
<b>CÓDIGOS DE MOTOR</b>	<p>2.2 / 2.5</p>

## KIT DE BLOQUEIO FORD

53293

133,50€

4,15

2

40

diesel

gasolina

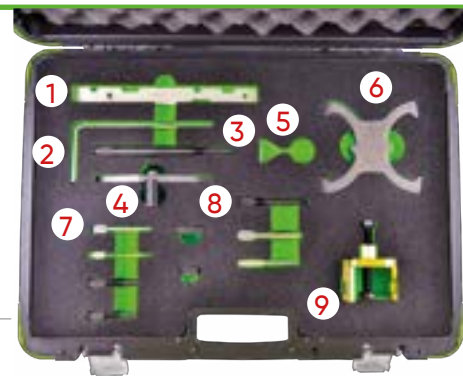

<b>MARCAS</b>	<p><b>FORD</b> B-Max (12-17), C-Max (07-17), Cougar (98-01), Courier (00-02), Escort (94-98), Fiesta (95-17), Focus (98-17), Focus C-Max (03-07), Fusion (02-12), Galaxy (06-15), Grand C-Max (10-17), Kuga (08-15), Maverick (01-07), Mondeo (93-15), Orion (94-94), Puma (97-02), S-Max (06-15), Tourneo Connect (02-15), Transit (06-11), Transit Connect (02-16), EcoSport (13-15), Tourneo Courier (14-15), Grand Tourneo Courier (13-15).</p>
<b>FERRAMENTAS OEM</b>	<p>303-376 (21-162B) (1), 303-1059 (2), 303-193 (21-104) (3), 303-393-01 (4), 303-1054 (5), 303-1097 (6), 303-748 (7), 303-734 (21-262) (8), 303-651 (21-229) (9), 303-393A (21-168) / 303-393-02 / 303-507 (21-210) / 303-620 (21-163) / 303-732 (21-260) / 303-735 (21-263).</p>
<b>CÓDIGOS DE MOTOR</b>	<p><b>GASOLINA:</b> AODA/B, ASDA, ASDB, CFBA, CGBA/B, CHBA/B, CJBA/B, CSDA/B, DHA, DHB, DHC, DHD, DHE, DHF, DHG, EDBB, EDDB, EDDC, EDDD, EDDF, EYDB, EYDC, EYDD, EYDE, EYDF, EYDG, EYDI, EYDJ, EYPA, EYPC, F8JA, F8JB, FHA, FHD, FHE, FHF, FUJA, FUJB, FXDA/C, FXDB/D, FXJA, FXJB, FYDA/C, FYDB/D, FYJA, FYJB, HWDA, HWDB, LIF, LIL, LIL, LIN, LIQ, LIT, LIV, LIW, M7JA, M7JB, MHA, MHB, NGA, NGB, NGC, NGD, QQDA/B/C, QQDB, RKA, RKB, RKF, RKH, RKJ, RKK, HXDA.  <b>DIESEL:</b> F6JA, F6JB, F6JC, HHJA, HHJB, G8DA, HHDA, HHDB, RTN, RTQ, RTP, C9DC, BHDA/B, BHPA, C9DA/B, F9DA/B, FFBA, FFDA, HCPA, HCPB, KKDA, P7PA, P9PA, QYWA, R2PA, R3PA, RWPA, G6DA, G6DB, G6DC, AZWA, QXWA.</p>

## KIT DE BLOQUEIO FORD

53653

195,00€

5,50

2

40



gasolina

**MARCAS** FORD: Fiesta, Focus, B-MAX, EcoSport.

**FERRAMENTAS OEM** 303-1605 (1), 303-1606 (2), 303-1604 (3), 303-1602 / 503-393A / (21-168) (4), 303-1054 (5), 303-732 (6)

**CÓDIGOS DE MOTOR** M1DD, M1JA, M1JC, M1JE, M1JHM1JJ, M1DA, M2DA, M2DB, M2DC, SFDBSFJA, SFJB, SFJC, SFJD

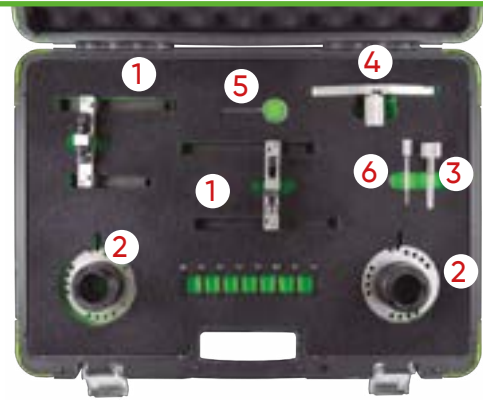

## KIT DE BLOQUEIO FORD

53324

12,50€

0,3

10

50



gasolina



**MARCAS**

FORD: B-Max (15-17), C-Max (07-10), Cougar (98-01), Fiesta (95-17), Focus (98-11), Focus C-Max (03-07), Fusion (02-12), Galaxy (06-15), Maverick (01-07), Mondeo (93-15), Puma (97-02), S-Max (06-15), Tourneo Connect (02-06), Transit (06-12), Transit Connect (02-06).  
 MAZDA: 121 ZQ (95-00), 2 DY (02-07), 3 BK (03-09), 3 BL (09-15), 5 CR (05-10), 5 CW (10-12), 6 GG/GY (02-07), 6 GH (07-15), MPV LW (02-05), MX-5 NC (05-16), Tribute EP (04-06).  
 VOLVO: C30 (06-13), S40 (06-12), S80 (07-11), V50 (04-12).

**FERRAMENTAS OEM**

FORD: 303-1054, 303-507 (21-210), 303-620 (21-163), 303-574, 303-748, 303-376 (21-162B), 303-376B  
 MAZDA: 49 JE01 061, 303-574, 49 JE02 061, 303-465, 49 JE01 054  
 VOLVO: 999 7152, 999 7151.

**CÓDIGOS DE MOTOR**

1.4 / 1.6

## KIT DE BLOQUEIO FORD 1.8TDDI / TDCI

53295

77,00€

2,1

5

165



diesel

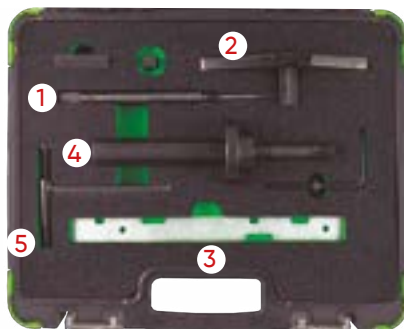

**MARCAS**

FORD

C-Max (07-10), Courier (00-02), Fiesta (00-02), Focus (98-11), Focus C-Max (03-07), Galaxy (06-10), Mondeo (07-10), S-Max (06-14), Tourneo Connect (02-13), Transit Connect (02-13).

**FERRAMENTAS OEM**

303-193 (21-104) (1), 303-393 (21-168) (2), 303-376 (21-162B) (3), 303-652 (21-230) (4), 310-095 (23-067) (5)

**CÓDIGOS DE MOTOR**

1.8D TDCi: BHPA, F9DA, F9DB, FFBA, FFDA, FFWA, HCPA, HCPB, KHBA, KKDA, KKDB, P7PA, P9PA, P9PB, QYBA, QYWA, R2PA, R3PA, RWPA, RWPC.  
 1.8D TDCi ECOnetic: KHBA.  
 1.8D Tdi: BHDA, BHDB, BHPA, C9DA, C9DB, C9DC.  
 1.8D Turbo: C9DC, RTN, RTP, RTQ.

## KIT DE BLOQUEIO FORD / MAZDA

53294

119,00€

3,7

2

40



diesel

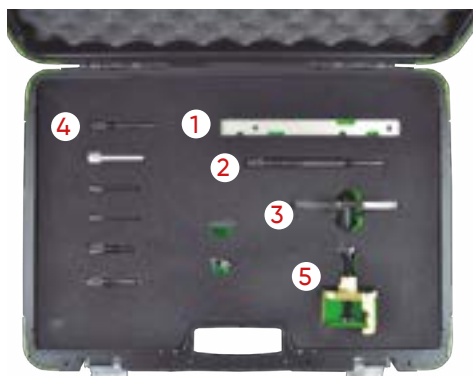

**MARCAS**

FORD: Courier (00-02), C-Max (03-10), Fiesta (02-11), Focus (98-11), Fusion (02-11), Galaxy (06-10), Kuga (06-10), Mondeo (07-10), S-Max (06-10), Tourneo Connect (02-13), Transit Connect (02-13).  
 PEUGEOT: Bipper (08-10) Dispatch/Jumpy III (07-12) Expert III (07-12) Nemo (08-10) Partner I/II (05-11) Partner III (08-16) 107 (05-10) 1007 (05-10) 206 (01-12) 206+ (09-13) 206 CC (05-07) 207 (06-13) 207 CC (07-15) 208 (11-15) 307 (01-08) 308 (07-15) 308 CC (09-15) 407 (05-11) 508 (04-15) 2008 (13-15) 3008 (09-15) 4008 (12-15) 5008 (09-15).  
 MAZDA: 2 (02-15), 3 (09-14).  
 CITROËN: C1 (05-10), C2 (03-10), C3 I/II (02-10), C3 III (10-15), C3 Pluriel (04-10), C3 Picasso (09-12), C4 (04-11), C4 II (11-15), C4 Picasso (06-12), C4 Grand Picasso (10-12), DS3 (09-12), DS4 (11-12), DS5 (12-15), C5 II (04-08), C5 III (04-12), Xsara II (02-04), Xsara Picasso (04-10).

**FERRAMENTAS OEM**

FORD: 303-376B (1), 303-193 (2), 303-393 (3), 303-732 (4), 303-651 (5), 303-393/01, 303-1059, 303-734, 303-735.  
 MAZDA: 303-732, 303-734, 303-735.  
 PSA: 0194-A, 0194-C, 0194B.

**CÓDIGOS DE MOTOR**

1.4D TDCi/Hdi: DV4TD(8HT), DV4TD(8HX), DV4TD(8HZ), DV4TD(8HW), DV4TED4(8HX), DV4TED4(8HV), DV4TED4(8HY), DV4C(8HP), DV4C(8HR), DV4TED(8HS), F6JA, F6JB, F6JC.  
 1.6D TDCi/HDi: DV6TED4(9HZ), DV6ATED4(9HX), DV6TED4(9HY), DV6DTE(9HP), DV6C(9HR), DV6ATED(9HX), DV6C(9HL), DV6TED(9HP), DV6ATED(9HY), DV6TED4(9HV), DV6TED4(9HX), DV6C(9HD), DV6C(BHX), DV6C(BHZ), DV6(9HR), DV6BTED4(9HW), DV6DTE(9HJ), DV6TED(9HN), DV6TED4BU(9HS), DV6BTED4(9HT), DV6BUTED4(9HT), DV6TED4B(9HV), DV6UTED4(9HX), DV6TED(9HD), DV6UTED4(9HU), DV6D(9HP), DV6TE-D4(9HV), DV6C(9HD), DV6TED4(9HW), DV6AT(9HX), DV6ATED(9HX), DV6CTED(9HC), DV6AUTED4(9HX), DV6TED4B, DV6DTE(9HF), HHJA, HHJB, G8DA, G8DB, HHDA, HHDB, MZ-CD, Y6.  
 1.8D TDCi/HDi: BHPA, C9DA/B, FFBA, G6DA, G6DB, G6DC, HCPA, HCPB, KKDA, P7PA, P9PA, R2PA, R3PA, RWPA.  
 1.8d: C9DC, RTN, RTQ.  
 1.8D Tdi: C9DA/B, C9DC.  
 2.0D TDCi/HDi: AZWA, G6DA, G6DB, G6DC, RHE(DW10CTED4), QXWA, QXWB.



## KIT DE BLOQUEIO PARA BOMBA DE INJEÇÃO FORD E JAGUAR DURATORQ

53296

60,00€



diesel

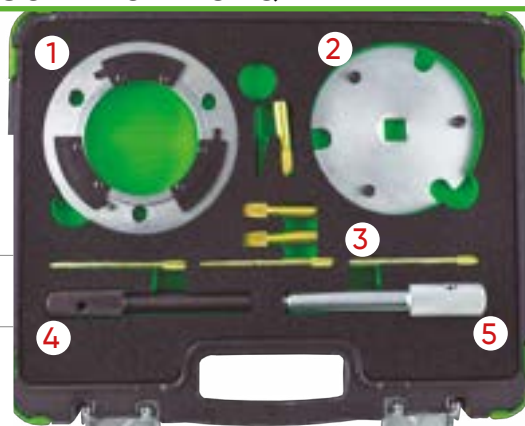

### MARCAS

FORD: Mondeo (00-07), Transit (00-14).  
CITROËN: Relay, Jumper III (06-13).  
FIAT: Ducato (06-11).

JAGUAR: X-Type (03-10).  
PEUGEOT: Boxer III (06-12).  
LAND ROVER: Defender Td4 (06-11).  
LDV: Convoy (02-06).

### FERRAMENTAS OEM

303-1151 (1), 303-679A/21-238 (2), 303-732 (3), 303-675/21-234 (4), 303-698/21-251 (5)

### CÓDIGOS DE MOTOR

12.0D Di/TDci/TDCi: ABFA, D3FA, F3FA, D5BA, D6BA, FIFA, FMBA, FMBB, HJBA, HJBB, HJBC, HJBE, N7BA, N7BB.  
2.2D TDCi/ECOnetic: BG, CYFA, CYFB, CYFC, DRFA, DRFB, DRFC, P8FA, P8FB, PGFA, PGFB, QJBA, QJBA (BG), QJBB, QJBC, QJBD, QVFA, QWFA, SRFA, SRFB, SRFC, SRFD, SRFE, UHFA.  
2.2D HDi/JTD: P22DTE (4HM), P22DTE (4HU), P22DTE (4HV).  
2.4D Di/TDCi: DOFA, D2FA, D2FB, D4FA, F4FA, FXFA, H9FA, H9FB, H9FD, JXFA, JXFC, PHFA, PHFC.  
2.4D TD/Tdi: ZSD 424.  
2.4D Td4: 244DT.

## KIT DE BLOQUEIO JAGUAR / LAND ROVER

53297

44,50€



diesel

### MARCAS

JAGUAR: MS TypeTDVi.  
LAND ROVER: Discovery 2.7 TDV6.  
RANGE ROVER: Sport 2.7 TDV6.

### FERRAMENTAS OEM

303-1117 (1), 303-1116 (2), 303-1132 (3), 303-1126 (4) (5)

### CÓDIGOS DE MOTOR

276DT, 306DT.

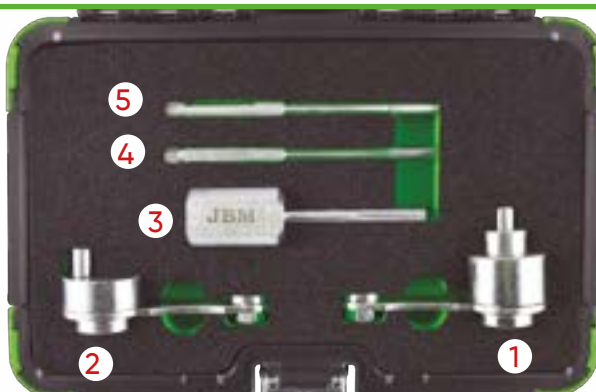

## KIT DE BLOQUEIO LAND ROVER

53298

84,50€



### MARCAS

MOTOR DIESEL: 200 TDI. 300 TDI. 2.5

- Pino de sincronização de transmissão manual.
- 200 tdi. 300 tdi. 2.5 motores diésel.
- Extrator de amortecedor de cambota.
- Ferramenta de bloqueio da bomba de injeção.
- Perno de sincronização da bomba de injeção 200/300 tdi.
- Ferramenta de sincronização do volante do motor 200/300 tdi.
- Ferramenta de sincronização da bomba dsp 2.5.
- Ferramenta de sincronização do volante do motor 2.5.



## KIT DE BLOQUEIO OPEL / FORD / FIAT / ALFA ROMEO / LANCIA / SUZUKI

53452

26,50€



diesel

### MARCAS

VAUXHALL/OPEL 1.3 CDTi: Agila, Corsa, Combo (03-08), Astra-H(05-08), Meriva, Tigra-B(04-08)  
SUZUKI 1.3 DDiS: Ignis, Wagon R(03-08), Swift(04-08)  
FORD: 1.3 TDCi  
FIAT/ALFA ROMEO/LANCIA: 1.3 JTD Multijet

### FERRAMENTAS OEM

104-A EN 46781 (1), EN 46785 (2)

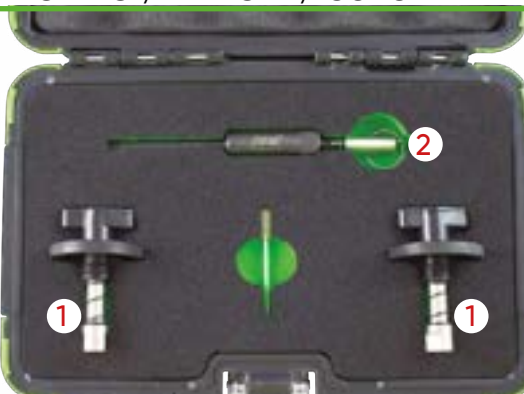

## KIT DE BLOQUEIO OPEL / VAUXHALL / CHEVROLET 2.0CDI

53300

40,50€



diesel

MARCAS	OPEL VAUXHALL CHEVROLET
FERRAMENTAS OEM	EN-48245 (1), EN-48246 (2), 205083060 (3) (4) (5) (6)
CÓDIGOS DE MOTOR	DIESEL 2.0 CDI  OPEL / VAUXHALL: Z20DM, Z20DMH CHEVROLET: LLWZ20DMH, RA 420, Z20SI, Z 20S3, Z 20S4, Z 20S5

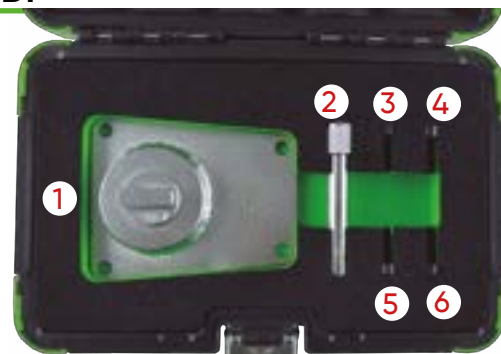

## KIT DE BLOQUEIO OPEL / VAUXHALL

53299

267,00€



diesel

MARCAS	OPEL / VAUXHALL
FERRAMENTAS OEM	EN-46788 (1), KM927 (2), EN-46789 (3), KM929 (4), EN-46785 (5), EN-46788 (6), 1 860 985 000 (7), KM932 (8), KM933 (9), EN-49978 (10), KM933 (11)
CÓDIGOS DE MOTOR	1.3 CDTi 16V, 1.9 CDTi, 2.0 DTi, 2.2 DTi.



## KIT DE BLOQUEIO AUDI / OPEL / VAUXHALL 1.0 1.2 1.4 TURBO

53651

82,50€

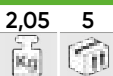

gasolina

MARCAS	OPEL: Adam, Ampera, Astra-J, Aveo, Corsa-D, Insignia, Meriva-B, Mokka, Zafira-C Tourer
FERRAMENTAS OEM	EN 49977-100 (1), EN 49977-200 (2), EN 49978 (3), KM 952 (4), KM 953-A (5), KM 955-1 (6), KM 955-2 (7).
CÓDIGOS DE MOTOR	1.0: A10XEP (LDB) 1.2: A12XEL (LWD), A12XER (LDC) 1.4: A14XEL (L2Z), A14XER (LDD), LDU A14NEL (LUH), A14NET (LUJ), Twinport / ecoFLEX engines A14XFL (LUU), A14NEL (LDD), A14NEL (LUJ), A12XEL (L2Q)



## KIT DE BLOQUEIO OPEL 1.0 / 1.2 / 1.4

53301

44,00€



gasolina

MARCAS	SUZUKI: Wagon R (05-08). VAUXHALL / OPEL: Agila (00-08), Astra-G (98-06), Astra G Classic II (03-10), Astra-H (04-11), Combo (04-12), Corsa-B (97-00), Corsa-C (00-07), Corsa-D (06-12), Meriva-A (04-10), Tigra-B (04-10).
FERRAMENTAS OEM	KM-953/09919-58310 (1), KM-952/09912-38310 (2), KM-954/09919-08310 (3), KM-6130 (4), KM-955/09919-58320 (5)
CÓDIGOS DE MOTOR	1.0 12v: X10XE, Z10XE, Z10XEP. 1.2 16v: X12XE, Z12XE, Z12XEP. 1.4 16v/ecoFLEX: Z14XEL, Z14XEP.

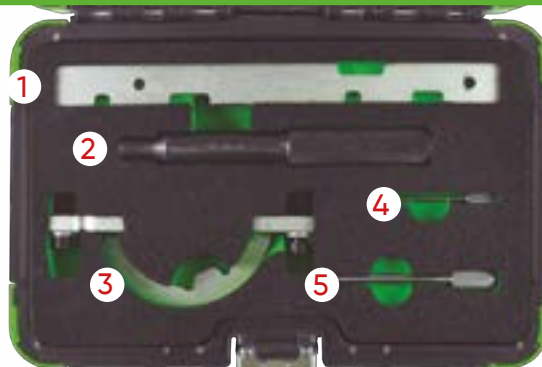

## KIT DE BLOQUEIO OPEL / VAUXHALL ASTRA, VECTRA, ZAFIRA 1.9CDTI

53302

44,00€

1,1

5

10

diesel

### MARCAS

SAAB: 9-3 (04-08), 9-5 (05-08).  
VAUXHALL / OPEL: Astra-H, Vectra-C, Signum (04-07), Zafira-B (05-07).

### FERRAMENTAS OEM

EN46789/32 025 008 (1) (3), EN46788/32 025 009 (2), KM6349 (4)

### CÓDIGOS DE MOTOR

Z19DT, Z19DTH, Z19DTL.



## KIT DE BLOQUEIO FIAT / OPEL

53303

89,00€

2

5

diesel

### MARCAS

FIAT: 19D/JTD (Motor Peugeot), 2.4D.  
ALFA ROMEO: 145, 146, 156 JTD.  
GM: GM 1.3, 1.6, 1.9, 2.0, 2.4 CDTI (2004 -).

### FERRAMENTAS OEM

EN-46789 (1), EN-46789-100 (2), EN-46785 (3), EN-46788 (4), EN-46781 (5), EN-46789 (6)

### CÓDIGOS DE MOTOR

GM: K1.3 CDTI | Z13DT Common Rail engine.  
1.9 CDTI / 04-12 - Z19DT | Z19DTH | Z19DTJ | Z19DTL  
2.0 CDTI / 08-12 - A20DT | LBS / LBX / LBY / LCDV  
SAAB: 1.9 TID.



## KIT DE BLOQUEIO SAAB / OPEL / VAUXHALL

53305

135,50€

3,6

2

42

gasolina

### MARCAS

VAUXHALL / OPEL: Antara (06-10), Calibra (93-98), Cavalier/Vectra-A (93-95), Omega-B (94-03), Signum (03-05), Sintra (96-99), Vectra-B (95-02), Vectra-C (02-05).  
SAAB: 900 (93-98), 9000 (95-97), 9-5 (98-03)

### FERRAMENTAS OEM

KM-800-1 (1), KM-800-2 (2), KM-800-20 (3), KM-800-10 (4), 83 95 006 (5), KM-800-30 (6), MKM-6038, 83 95 006 (7)

### CÓDIGOS DE MOTOR

2.5 V6: Saab; B2581, Vauxhall/Opel; C25XE, X25XE.  
2.6 V6: Vauxhall/Opel; Y26SE.  
3.0 V6: Saab; B308E, B308i; Vauxhall / Opel; X30XE.  
3.2 V6: Vauxhall/Opel; Y32SE, Z32SE.



## KIT DE BLOQUEIO FIAT

53304

257,50€

6

2

42

diesel

gasolina

### MARCAS

FIAT

### FERRAMENTAS OEM

1 860 874 000 (1), 1 860 895 000 (2), 1 860 898 000 (3), 1 860 905 000 (4), 1 860 845 000 (3)

### CÓDIGOS DE MOTOR

MOTOR GASOLINA: Fiat Brava , Bravo, Barchetta, Cargo, Coupe, Marea, Palio, Weekend, Punto, Multila, Stilo, Idea, Doblo Twin Cam Engines - 1.2, 1.4, 1.6, 1.8, 16V  
MOTOR DIESEL: Fiat Brava, Bravo, Marea, Weekend, Palio, Punto, Multila, Doblo, Ulysse, Ducato, Stilo JTD Diesel Engines - 1.9D/TD . 1.9JTD . 2.4TD/JTD.

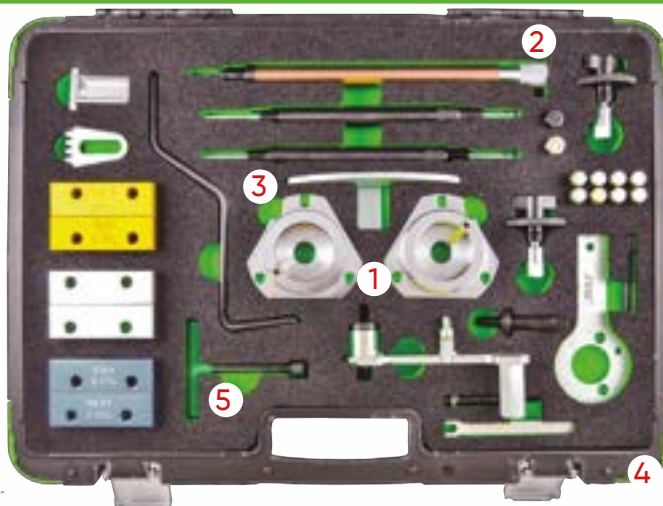



## KIT DE BLOQUEIO FIAT 1.2 16V

**53306**

54,50€



gasolina



<b>MARCAS</b>	FIAT: Fiat 1.2L 16V, Fiat Punto / Brava / Bravo / Stilo
<b>FERRAMENTAS OEM</b>	1860992000 (1) (2), 1871000900 (3), 1860987000 (4), 186985000 (5)
<b>CÓDIGOS DE MOTOR</b>	176 B9000, 182 B2.000, 188 A5.000

## KIT DE BLOQUEIO ALFA / OPEL / VAUXHALL 1.6 / 1.8 16V

**53307**

38,50€



gasolina

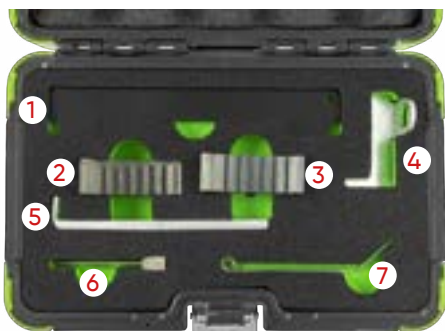

<b>MARCAS</b>	OPEL / VAUXHALL: Corsa-D, Agila, Astra-G-H, Meriva, Zafira-B, Vectra-C, Signum, Insignia	1.6, 1.8
	CHEVROLET: Aveo, Cruze, Orlando	1.4, 1.6, 1.8
	ALFA ROMEO: 159 FIAT: Croma	1.8
<b>FERRAMENTAS OEM</b>	E10290 (1), 23056-06 (2) (3), E10230 (4), 23164-04 (5), 23174-01 (6), 23056-05 (7)	
<b>CÓDIGOS DE MOTOR</b>	Opel / Vauxhall: Z16LEL, Z16LER, Z16LET, Z16XE1, Z16XEP, Z16XER, A16XER, 18XER, A18XER, 2HO/A18XEL. Chevrolet: G14D, LDD, LXV (F16D4), 2HO(Z18XER). Alfa / Fiat: 939A4.000.	

## KIT DE BLOQUEIO FIAT / OPEL / VAUXHALL 2.2 16V CADEIA

**53316**

31,50€

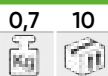

gasolina



<b>MARCAS</b>	OPEL: Astra-G (2000-2006), Astra-H (2006-2011), Signum (2003-2008), Vectra-B (2000-2002, Vectra-C (2002-2008), Zafira-A (2000-2005), Zafira-B (2005-2012), Speedster (2000-2006). VAUXHALL: VX220 (2000-2006). FIAT: Croma (2005-2009).
<b>CÓDIGOS DE MOTOR</b>	VAUXHALL / OPEL: Z22SE, Z22YH FIAT: 194A1.000.

## KIT DE BLOQUEIO FIAT / IVECO 2.3 / 3.0 JTD

**53319**

15,00€



diesel



<b>MARCAS</b>	FIAT: 2.3 / 3.0 JTD. IVECO: Daily.
<b>FERRAMENTAS OEM</b>	99360614, 1 860 617 000, 99360615, 2 000 018 200.
<b>CÓDIGOS DE MOTOR</b>	FIAE0481C, FIAE0481D, FIAE0481N, FICE0481A/D.

## KIT DE BLOQUEIO CITROEN/PEUGEOT 1.0/1.2 VTI

**53876**

63,50€



gasolina



<b>MARCAS</b>	CITROEN: C3 (III) PEUGEOT: 208, 308, 2008 SUV (2012-2014)
<b>FERRAMENTAS OEM</b>	0109-2A (1), 0109-2B (2)
<b>CÓDIGOS DE MOTOR</b>	1.0/1.2 VTI EBO, (ZMZ), EB2, (HMZ)

## KIT DE BLOQUEIO CITROËN / PEUGEOT

53313

139,00€



diesel gasolina

### MARCAS

CITROËN: AX, BX, Boxer, Berlingo, C25, Dispatch, Evasion, J5, Jumpy, Jumper, Relay, Saxo, Synergie, Visa, XM, Xsara, Xantia, XZ, ZX.  
PEUGEOT: 106, 205, 206, 305, 306, 307, 309, 405, 406, 605, 607, 806, Expert, Partner, Solara, Talbot.

### FERRAMENTAS OEM

7099TM (1), 0188X (2), 0188P (3), 0189AZ (4), 0188H (5), 0132AJ1 (6), 0189A (7), 0188PM (8), 21-260 (9), 4527-TS1 (10), M8X70 (11), 0188K (12), 0188J (13), 0132Q (14), 4507-TL (15), 4507-TJ (16), 9044-T (17), 4507-TJ (18), 5711-TA (19), 7014-TJ (20), 7017-TR (21), 0188X (22), 7017-TW (23), 7014-TM (24), 0189L (25)

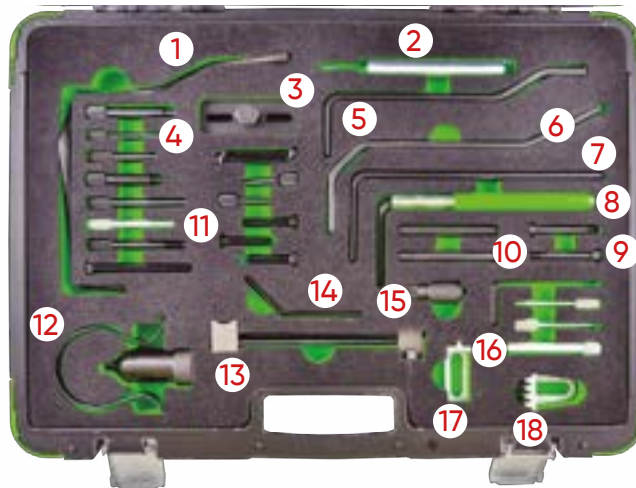

## KIT DE BLOQUEIO CITROËN / PEUGEOT 1.8 / 2.0

53314

97,50€

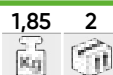

gasolina

### MARCAS

CITROËN: C4 Picasso/Grand Picasso (06-10), C5 II (04-08), C8 (05-10), Dispatch/Jumpy (07-11), Xsara 2.0 16v, C5 1.8/2.0/HPI, Xsara Picasso 1.8/2.0 16v (02-05).  
PEUGEOT: 406 1.8 16v (00-04), 407 (06-10), 807 2.0 16v (02-05).

### FERRAMENTAS OEM

0189S2 (1), 0188J (2), 0188J2 (2), 0189S1 (3), 21-260 (4), 0189B (5), 0188M (6), 0188AH (7), 0189R (8)

### CÓDIGOS DE MOTOR

1.8 16v: EW7A(6FY).  
2.0 16v: EW10A(RFJ), EW10ABE4(RFH), EW10J4S (RFK).

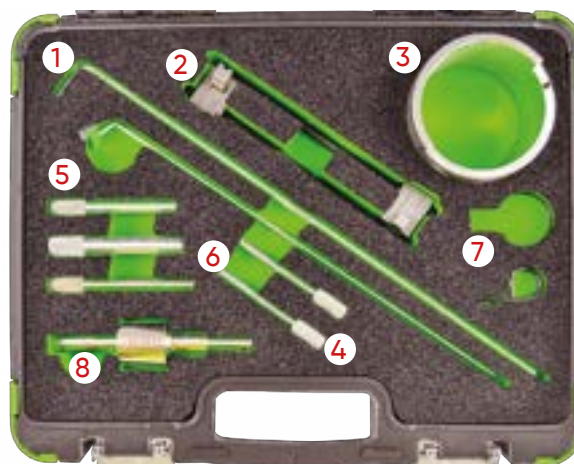

## KIT DE BLOQUEIO ALFA ROMEO

53308

52,50€



gasolina

### MARCAS

ALFA ROMEO: 145,146,147,155,156, 1.4 1.6 1.8 2.0 TS, 1.4/1.6 16v; 145/146/147/155/156 (96-10), 1.8 16v; 145/146, (96-01), 155/156 (96-06), Spider/GTV (98-05), 2.0 16v; 145/146 (96-01), 147 (01-10), 155/156 (95-02), 166 (98-07), Spider/GTV (96-05), Púrpura: 1.4, 1.6 // Azul: 1.8, 2.0

### FERRAMENTAS OEM

1822149000 (1), 1822154000 (2), 1825041000 (3), 1825042000 (4)

### CÓDIGOS DE MOTOR

1.4/1.6-321.02, 321.03, 321.04, 335.03, 676.01  
1.8/2.0-323.01, 672.04, 162.01, 323.10, 671.06, 322.01, 671.02, 322.05, 341.03, 363.01.

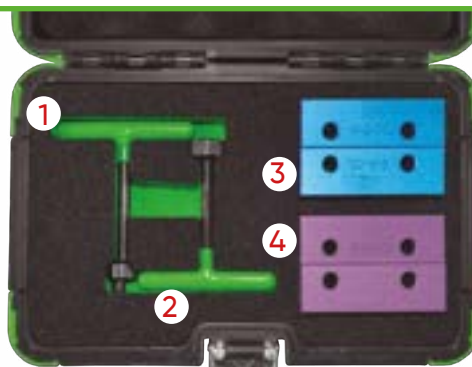

## KIT DE BLOQUEIO ALFA / FIAT / LANCIA 1.4 / 1.6 / 1.8 / 2.0 16V

53309

262,50€

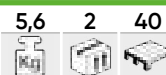

gasolina



### MARCAS

ALFA ROMEO: 145,146,147,155,156, 1.4 1.6 1.8 2.0 TS, 1.4/1.6 16v; 145/146/147/155/156 (96-10), 1.8 16v; 145/146, (96-01), 155/156 (96-06), Spider/GTV (98-05), 2.0 16v; 145/146 (96-01), 147 (01-10), 155/156 (95-02), 166 (98-07), Spider/GTV (96-05), Púrpura: 1.4, 1.6 // Azul: 1.8, 2.0  
FIAT: Barchetta (96-00), Brava (95-00), Bravo (95-00), Coupe (96-01), Marea (96-00), Marea Weekend (96-00), Punto/Punto Classic (99-06), Stilo (01-08)  
LANCIA: Deada (95-99), Delta (96-99), Kappa (98-02), Lybra (99-06).

### CÓDIGOS DE MOTOR

1.4 16v: 335.03  
1.6 16v: 321.02, 321.03, 321.04, 372.03, 676.01  
1.8 16v: 322.01, 322.05, 671.06, 182A2.000, 183A1.000, 183A6.000, 188A6.000, 192A4.000  
2.0 16v: 162.01, 323.01, 323.1, 341.03, 363.01, 672.04  
2.0 20v: 175A3.000, 182A1.000, 182B7.000, 185A8.000.

## KIT DE BLOQUEIO FIAT / ALFA / LANCIA

53310

455,00€

10,7 2 40



gasolina

<b>MARCAS</b>	ALFA FIAT LANCIA	Alla, Barchetta, Bravo, Brava, Coupe, Delta, De- dra, Punto, Spider, GT
<b>FERRAMENTAS OEM</b>	1860845000 (1), 1822154000 (2), 1860905000 (3), 1860992000 (4), 1860895000 (5), 1860874000 (6), 1860985000 (7), KM571A (8), 1860896000 (9), 0153A (10)	
<b>CÓDIGOS DE MOTOR</b>	1.2 / 16V, 1.4 / 12V, 1.6 / 16V, 1.6 eco, 1.8, 2.0 / 16V, 2.0 / 20V, 2.4 / 20V, 3.0 / V6.	



## KIT DE BLOQUEIO FIAT / ALFA / FORD

53312

127,00€

2,6 5



gasolina



<b>MARCAS</b>	FIAT: New 500 (07-09), Idea (04-09), Linea (07-09), Gran- de Punto (07-09), Doblo 1 Cargo (05-09), Panda EV02 (05) FORD: KA 1.2 Duratec (09) ALFA ROMEO
<b>FERRAMENTAS OEM</b>	1860987000 (1), 2000004400 (2), 2000015800 (3), 2 000004300 (4), 2000004500 (5)
<b>CÓDIGOS DE MOTOR</b>	1.2: 169A4.000 / 199A4.000 . 1.4: 350A.1000 / 188A4.000-EV02.

## KIT DE BLOQUEIO RENAULT / NISSAN / OPEL / VAUXHALL 2.0 / 2.3 DCI / CDTI M9R / M9T

53311

97,00€

2,15 5 135



diesel



<b>MARCAS</b>	NISSAN: Primastar X83 (06-15), Qashqai/Qashqai+2 J10 (07-14), X-Trail T31 (07-14). VAUXHALL/OPEL: Movano-B (10-17), Vivaro (06-15). RENAULT: Espace/Grand Espace IV (06-10), Koleos (08-15), Laguna II (05-07), Laguna III (07-14), Master III (10-15), Megane II (06-10), Scenic/Grand Scenic II (06-09), Scenic/Grand Scenic III (09-15), Traffic II (06-14), Vel Satis (05-10)
<b>FERRAMENTAS OEM</b>	Mot1769 (1), EN-48334 (2), Mot1766 (3), EN-48330 (3), KM-6130 (4), EN-48332 (5), Mot1773 (6), EN-48831 (6)
<b>CÓDIGOS DE MOTOR</b>	2.0D dCi M9R: 630, 780, 782, 784, 786, 788, 830, 832, 833, 834, 835, 836, 838, 855, 856. 2.0D CDTi M9R: 630, 780, 782, 784, 786. 2.3 Bi-CDTi: LP6/M9T706, LW7/M9T706. 2.3D dCi M9T: 670, 672, 676, 678, 680, 686, 690, 692, 694, 698.



VÁRIOS





# KIT DE BLOQUEIO FORD / SEAT / VOLKSWAGEN / MAZDA / VOLVO

53770

190,50€

6,15 3 36



diesel

gasolina

## MARCAS

**FORD:** Fiesta, Fusion, Courier, Escort, Focus, Focus C Max, Puma, Mondeo, Sierra, Cougar, Galaxy, C-Max, Orion, Tourneo Connect, Transit, Transit Connect.  
**VW:** Sharan.  
**SEAT:** Alhambra.  
**MAZDA:** 121.  
**VOLVO:** S40, V50.

## FERRAMENTAS OEM

303-1061 (1), 303-1054 (2), 23-059 / 310-085 (3), 21-105 (4), 323-029 (6), 0194-B / 21-263 / 303-735 / 49 JE 02 021 (7), 0132-AB / 0178-D / 21-151 (9), 0194-C, 21-262, 303-734, 49 JE 02 020 (10), 21-238 / 303-679A / 303-1151 (11), 21-238 / 303-679A / 303-1151 (12), 303-1054 (13), 303-1151 (14), 21-238 / 303-679A (15), 303-393 / 303-393-02 (16), 303-1097 (17), 21-168 / 303-393 (18), 303-0985 (20), 2064 / 23-047 / 310-055 / U20003 (21), 303-652 (22), 21-229, 303-651 (23), 303-748 (24), 21-210 (25), 21-260, 303-732 (26), 21-163, 303-620 (27), 21-234 / 21-251 (28), 303-675 / 303-698 (29), 21-104 / 303-193 (30) / 21-162B / 303-367 / 303-376 (31), 21-162B / 303-376 / 303-376B (32), 23-019 (33), 23-058 / 310-084 (34), 0153-M / 0178-C / 0178-D (35), 0178-B / 5711-TB (36), 21-123 (37), 23-020 (38), 21-234 / 21-251 (39), 303-1059 (40), 23-019 (41), 303-1060 (42), 303-393 / 303-393-01 (43)

## CÓDIGOS DE MOTOR

FUJA, FUJB, FXJA, FXJB, FXJB, FYJA, FYJB, F8JA, F8JB, M7JA, M7JB, DHA, DHB, DHC, DHD, DHE, DHF, DHG, FHA, FHE, LIT, LIV, LIE, LIG, LIH, LJK, RDA, RDB, RKC, RQB, RQC, FXDA/C, FXDB/D, FYDA/C, FYDB/D, FYDH, HWDAlZ, AHU, AVG, AFN, D24, D24T, D24TIC, RFN, RTJ, RTK, RVA, RFK, RKD, B416AS3, DV4TD (8HW/8HX/8HZ), DV4TED4(8HV/8HY), DV6ATED4 (9HX/9HY/9HZ) F6JA, F6JB, F6JC, G8DA, G8DB, KKDA, SNJA, SNJB, STJA, STJB, ASDA, ASDB, FXJC, SPJA, SPJC, FYJC, HWDA, HWDB, SHDA, SHDB, SHDC, JQDA, LQDB, JTDA, JTDB, HXDA, HXJA, HXJB, IQDA/B, IQDB, PNBA, PNDA, RHBA, SIDA, F6JD, TZJA, TZJB, HHDA, HHDB, HHJA, HHJC, HHJD, HHJE, HHJF, RTA, RTB, RTC, RTD, RTG, RTE, RTF, RTH, RTJ, RTK, RFN, BHPA, HCPA, HCPB, KKDA, P7PA, P9PA, P9PB, R2PA, R3PA, RWPA, RWPC, F9DA/B, FFBA, FFWA, KHBA, QYBA, QYWA, KKDB, C9DC, RVA, IZ, AFN, AHU, ANU, AUY, G6DA, G6DB, G6DC, G6DD, G6DE, G6DF, G6DG, UFDB, TXDB, TYDA, UKDB, QXBA, AZBA, KLBA, QXBB, LPBA, AZBC, TYBA, UKBA, UFBA, TXBA, IXDA, QXWA, QXWB, AZWA, KLWA, AZWC, TYWA, UKWA, TXWA, UFWA, UFDA, TXDA, UKDA, Q4BA, KNBA, 4BA, 4BB, 4BC, 4CC, 4FA, 4CA, 4CB, 4DA, 4EA, 4FA, 4FB, 4FC, 4FD, 4GA, 4HB, 4HC, 4EB, 4EC, 4ED, 4GA, 4GB, 4GC, 4GD, 4GE, 4GF, 4HA, 4HD, FMBA/B, D5BA, ABFA, D3FA, D6BA, HJBA/B, F3FA, D2FA, D4FA, F4FA, F5FA, DOFA, QJBA, QJBB, QJBC, QJBD, FXFA, H9FA, H9FB, N7BA, N7BB, MZ-CD 1,6, V6



# KIT DE BLOQUEIO OPEL / CHEVROLET / SAAB / FIAT / LANCIA / SUZUKI / FORD

53774

189,50€

6,95 3 36



diesel

gasolina

## MARCAS

**ALFA:** 145, 146, 147, 156, 159, 166, GT, Crosswagon Q4  
**FIAT:** Punto, Grande Punto, Bravo, Brava, Marea Weekend, Stilo, Doblo, Cargo, Multipla Idea, Panda  
**LANCIA:** Ypsilon, Musa, Lybra, Thesis  
**OPEL:** Corsa B/C, Combo, Tigra, Agila, Tigra B, Meriva, Astra F/G/H, Astravan, Speedster VX220, Zafira A/B, Vectra B/C, Signum, Omega B, Sintra, Frontera A/B, Astravan, Kadett, Ascona, Omega, Monterey, Antara, Croma, Speedster VX220  
**SUZUKI:** Ignis, Swift, Wagon R+  
**FORD:** Ka  
**CHEVROLET & DAEWOO:** Epica, Captiva, Nubira, Lacetti, Evanda  
**SAAB:** 9-3, 9-5 (98-04)

## FERRAMENTAS OEM

1860905000 / 1860905010 / EN-46788 (1), KM-6148 (2), KM-6148 (3), 1870900400 / 1871000200 (4), KM-954 (5), KM-J-43651 (6), 1860905000 / 1860905010 / EN-46788 (7), KM-852 (8), KM-853 (9), 1870900300 / 303-1468 (10), EN-46785 / KM-951 (11), KM-932 (12), 1860703000 (13), KM-955 (14), KM-6130 / KM-6349 / KM-6349 (15), KM-927 (16), EN-48245 (17), KM-933 (18), EN-46785 (19), 1860985000 / 1871000900 / EN-46781 (20), 1860985000 / 1871000900 / EN-46781 (21), EN-48246 (22), KM-929 (23), 1870896900 / EN-46789 (24), KM-952 (25), 21-162B / 303-376 / 303-376B (26), KM-933 (27)

## CÓDIGOS DE MOTOR

X14XE, Z14XE, X16SEJ, X16XE, X16XEL, Y16XE, Z16XE, Z16YNG, C18XEL, X18XE, X18XE1, Z18XE, Z18XEL, C20SEL, C20XE, X20XEV, Z20LEH, Z20LEL, Z20LER, Z20LET, X22SE, X22XE, Y22SE, Y22XE, Z22XE, D223L, X10XE, Z10XE, Z10XEP, X12XE, Z12XE, Z14XEP, X20DTL, X20DTH, X22DTH, Y22DTR, 169A1.000, 955A4.000, 350A3.000, 192B4.000, 198A2.000, 350A2.000, 955A3.000, 192A8.000, 198A6.000, 198A3.000, 199B1.000, 199B2.000, 199A2.000, 199A3.000, 199A9.000, 940A3.000, 188A3.000, 939A2.000, 188B2.000, 188A8.000, 188A9.000, 323.02, 371.01, 937A2.000, 182B4.000, 182B9.000, 188A2.000, 188A7.000, 192A9.000, 186A6.000, 186A8.000, 192A1.000, 192A3.000, 192B1.000, 192A5.000, 186A9.000, 939A1.000, 199A5.000, 223A7.000, 223A9.000, 342.02, 362.02, 841G.000, 841H.000, 841P.000, 939A3.000, 185A2.000, 185A6.000, Z13DT, Z13DTJ, Z13DTH, Z19DT, Z19DTH, Z19DTJ, Z19DTL, X10XE, Z10XE, Z10XEP, Z12XE, Z14XEP, X16SZR, Z16SE, 4EC1/T, 4EC1, 4EE1/T, 4EE1, X17DT, Y17DT, Y17DTI, Y17DTL, 16DA, 17D, 17DR/X, 7DTL, X17DTL, 4-JX1/4, JG2T, 4FC1/T, 4FD1, X20DTL, Y20DTL, D223L Z20DMH, Z20DM, RA420, Z20S1, 194A1.000, Z22SE, Z22YH



# KIT DE BLOQUEIO FIAT / ALFA / LANCIA / OPEL / SUZUKI / FORD

53773

293,00€



diesel

gasolina

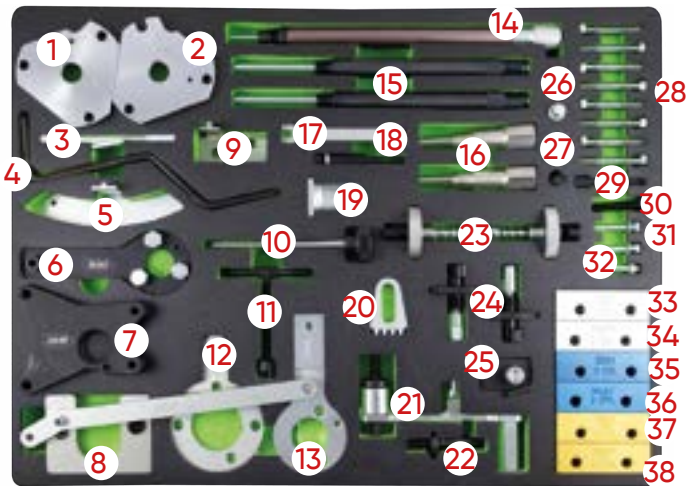

<b>MARCAS</b>	ALFA: Romeo 145, 146, 147, 155, 156, 159, 166, Spider, GTV, TS, GT, Crosswagon Q4 FIAT: Punto, Grande Punto, Brava, Bravo, Marea, Weekend, Stilo, Doblo, Cargo, Idea, Panda, Multipla, Palio, Stilo, 500 LANCIA: Lybra, Ypsilon, Thesis, Musa OPEL: Corsa, Agila, Meriva, Combo, Vectra, Zeta, Astra, Insignia, Signum 19 CDTi SUZUKI: Ignis, Swift, Wagon R+ FORD: Ka
<b>FERRAMENTAS OEM</b>	1860874000 (1), 1860874000 (2), 2000004400 / 2190754400 (3), 1860863000 (4), 1860898000 (5), 2190754500 (6), 2000004300 (7), 1870900400 (8), 1860703000 (9), 1860933000 (10), 1860845000 (11), 1870900300 (12), 1860905000 / EN-46788 (13), 1895443000 (14), 1860992000 (15), 1870896900 (16), 1860987000 (17), 1860905000 (18), 1860771000 (19), 1860161000 (20), 1860876000 (21), 1860876000 (22), 1871000900 (23), 1860985000 (24), 2000004200 / 2190754200 (25), 1860965000 (29)
<b>CÓDIGOS DE MOTOR</b>	176B9.000, 182B2.000, 188A5.000, 843A1.000, 323.02, 371.01, 182B4.000, 182B9.000, 186A6.000, 188A2.000, 188A7.000, 188B2.000, 192A1.000, 192A3.000, 937A2.000, 939A1.000, 192A5.000, 192B1.000, 198A5.000, 937A5.000, 939A2.000, 325.01, 342.02, 362.02, 185A6.000, 841C.000, 841G.000, 939A3.000, 940A3.000, 940A4.000, 940A5.000, Z19DT/DTH/DTR/DTJ/DTL, 169A1.000, 955A4.000, 350A3.000, 192B4.000, 198A2.000, 350A2.000, 955A3.000, 192A8.000, 198A6.000, 198A3.000, 199B1.000, 199B2.000, 199A2.000, 199A3.000, 199A9.000, 188A3.000, 188A8.000, 188A9.000, 192A9.000, 186A8.000, 186A9.000, 199A5.000, 223A7.000, 223A9.000, 841H.000, 841P.000, 185A2.000, Z13DT, Z13DTJ, Z13DTH, 182A4.000, 182A6.000, 182B6.000, 178B3.000, 186A3.000, 186A4.000, 350A1.000, 169A4.000, 188A4.000, 199A4.000, 199A7.000

# KIT DE BLOQUEIO FIAT / FORD / CITROËN / PEUGEOT

53771

154,50€



diesel

gasolina

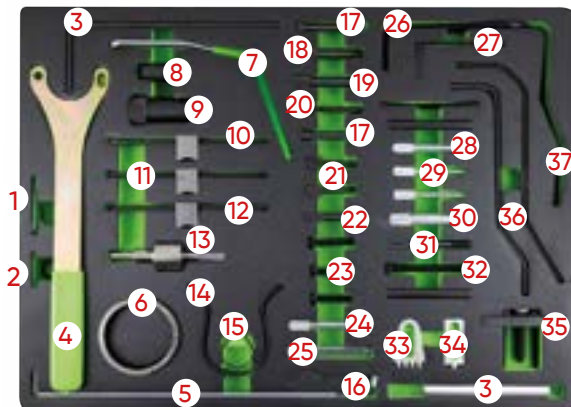

<b>MARCAS</b>	FIAT: Ulysse, Scudo, Ducato LANCIA: Zeta, Phedra FORD: Fiesta, Fusion, Focus, Focus C-Max CITROËN: C15, C1, C2, C3 Pluriel, C4, C4 Picasso, C5, C6, C8, DS3, DS4, DS5, Xantia, Xsara, Xsara Picasso, Evasion, Berlingo, Jumpy, Jumper, Saxo, ZX, XM, Evasion, AX PEUGEOT: 107, 1007, 206 cc, 207, 208, 306, 307 cc, 308, 406, 407, 508, 607, 806, 807, Partner, Expert, Boxer, 206, 106, 605, 205, 405
<b>FERRAMENTAS OEM</b>	4200-TH (1), 0117-AR (2), 0188-X (3), 0606-A1A2 (4), 0188-Q2 (5), 0189-S1 (6), 7017-TR (7), 0132-P / 4507-TL (8), 0189-C (9), 0188-J1 (10), 0188-J2 (11), 0178-E (12), 0189-R (13), 0132-AK / 0188-AK / 0189-K / 0153-AK / 4533-TAD / MOT 1436 (14), 0188-AH (15), 0189-S2 (16), 0153-AB / 9041-TZ (17), 0153-M / 0178-C / 0178-D / 7014-TM / 9767-94 (18), 0189-A (19), 4527-TS1 (20), 0153-AB / 9041-TZ (21), 0189-B / 21-163 (22), 0132-AJ1 / 0153-G / 0188-M / 0189-J / 4533-TAC1 / 5711-TA (24), 0189-L (25), 0188-D / 7017-TM (26), 0132-X / 0188-Q1 / 4507-TJ / 9767-89 (27), 0194-B (28), 0132-AB / 0194-A (29), 0194-C / 21-262 / 303-734 (30), 4527-TS2 (31), 0188-E (32), 0153-A / 6012-T / 9765-54 (33), 0134-AF / 0134-Q / 0188-F / 9004-T (34), 0188-P2 / 0188-P / 174 / 7015-T (35), 0153-U 7019-T (36), 0153-N / 0188-Y / 7014-TJ / 7099-TM / 9797-34 (37)
<b>CÓDIGOS DE MOTOR</b>	F6JA, F6JB, F6JC, G8DA, G8DB, HHDA, HHDB, HHJA, HHJB Citroën_Peugeot: 1.0 / 1.1 / 1.4 / 1.6 / 1.6 16V, 1.4 / 1.6HD1 / 1.8 / 1.8 16V / 2.0 / 2.0 Turbo, 1.9D / 2.0HD1 / 2.2HD1 / 1.8 16V / 2.0 16V TU9 (CDY/CDZ), TU1 (HDY/HDZ/HFX/HFY/HFZ), TU3 (KDX/KDY/KDZ/KFX/KFZ), TU5JP4 (NFU/NFX), TU5 (BDY/BFZ/NFT/NFV/NFW/NFY/NFZ), XU7 (LFW/LFX/LFZ), EW7J4 (RLZ), XU7JP4 (LGY), XU10 (RFL/RFU/RFW/RFX/RGX/RGY), XU10JP4 (RGX/RGY), EW10A (RFJ), EW10J4S (RFK), EW10D (RLZ), EW12J4 (3FZ), ET3JE (KFU), TU3A/JP (KVF/KFW), DV4TD (8HW/8HX/8HZ), DV4TED4 (8HV/8HY), DV6A-TED4 (9HX/9HY/9HZ), EW10-CVI (RLZ), EW12 (3FZ), DW8 (WJZ/WJY), DW10 (RHY/RHV/RHZ/RHS/RHM/RHW/RHT/RHR/RHX), DW12 (4HX/4HZ/4HW/4HY), EW7J4 (6FZ), EW10J4 (RFR), EW10J4D (RLZ), DW12TED4 (4HW), DW10ATED (RHT/RHV/RHW/RHX/RHZ) Ford 1.4 / 1.6 Durateco TDCI

# KIT DE BLOQUEIO FORD / VAG / MAZDA / VOLVO

53772

211,00€



diesel

gasolina

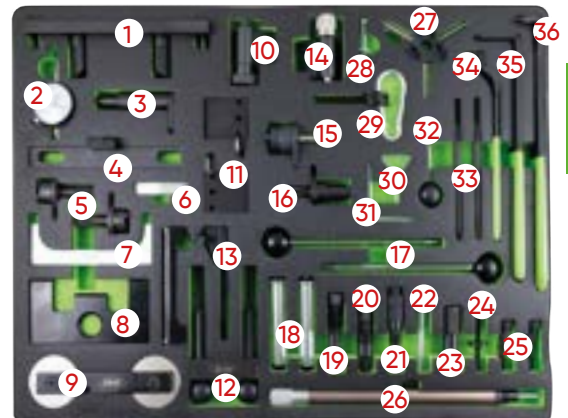

<b>MARCAS</b>	AUDI: 80, A1, A2, A3, S3, A4, A5, A6, TT, Q5 SEAT: Arosa, Ibiza, Cordoba, Leon, Toledo, Alhambra, Altea, Inca (99-04) SKODA: Fabia, Octavia, Superb VW: Lupo, Polo, Fox, Golf, Bora, Jetta, Golf Plus, Passat, Beetle, Touran, Sharan, Caddy, Caddy Maxi, Transporter, Golf VI Cabrio, Tiguan FORD: Galaxy
<b>FERRAMENTAS OEM</b>	T10252 (1), VAS6079 (2), T10121 (3), MP1-1312 / T10098 / T20038 / T20038 (4), T10123 (5), 23-058 / 310-084 / T10008 (6), 2065A / T10008 / U40021 (7), 3418 (8), T10171 (9), 23-059 / 23-059 / 310-085 / T10050 / T10050 (10), 3458 / T30094 (11), T10016 / T10074 / T10074 (12), T10100 (14), T10414 (15), 3366 / T20018 / T20044 (16), 3411 (17), 3369 / T30092 (18), T10341 (19), 3242 / T40069 / T30052 (20), T40026 (21), 3359 / MP1-301 / T20102 (22), 2064 / U20003 (23), T10120 (24), MP1-1312 / T10098 / T20038 (25), T10170 (26), T00115 / T10264 / T40098 (27), T10092 (28), T00115 / T10264 / T40098 (29), 303-1054 / T10115 (30), T10060 / T10060A (31), 3359 / MP1-301 / T20102 (32), T10340 (33), 2587 (34), 3387 / U30009A (35), 3387 / T10020 (36)
<b>CÓDIGOS DE MOTOR</b>	ARC, ATN, AUS, AVY, AZD, AFH, BCA, AJV, AKQ, AUA, AUB, AXP, AFH, AFN, AFK, AHW, AHU, APE, AQQ, AUS, AXP, AZD, BBY, BBZ, BCB, ANY, AZY, AMF, ATL, BAY, BHC, BMS, BNM, BNV, BWB, AJM, AMG, ANU, ARL, ASZ, ATD, ATJ, AUY, AVB, AVF, AVQ, AVX, AXB, AXC, AXR, BEW, BJB, BKC, BKE, BLS, BLT, BMT, BPX, BRB, BRM, BRN, BRS, BRU, BSU, BSW, BTB, BUK, BVK, BXE, BXF, AZV, BDJ, BDK, BGW, BHW, BKD, BKP, BLB, BMA, BMM, BMN, BMP, BMR, BNA, BPW, BRC, BRE, BRF, BRU, BUZ, BE, BVF, BVG, BVH, BWK, BTS, BMY, BLF, BWV, AZV, BKD, AWY, AZQ (55 - 64 PF), AXU, BAG, BKG, BLF, BLN, BLP, BFV, BKF, BNU, BVP, BVR, IZ, CBZA, CBZC, CBZB, CAXA, CAGA, CAGB, CAGC, CAHA, CAYA, CAYB, CAYC, CBAA, CBAB, CBAC, CBBA, CBBB, CBDA, CBDB, CBDC, CBEA, CECA, CKUB, AZV, BDJ, BHP, BKD, BLB, BMA, BMM, BMN, BMP, BMR, BNA, BPW, BRC, BRE, BRF, BRU, BSS, BUJ, BUZ, BVA, BVE, BVF, BVH, BWV, ACV, ACV, AFB, AGX, AHD, AHY, AHY, AJT, AKE, ANJ, APA, AUF, AXG, AXG, AXL, AYC, AYM, AYY, BAU, BBE, BBF, BCZ, BDG, BDH, BFC, BJJ, BJK, BJL, BJM





# KIT DE BLOQUEIO VOLVO 3.0 / 3.2T6 FREELANDER2 3.2I

**53315**

262,50€



gasolina

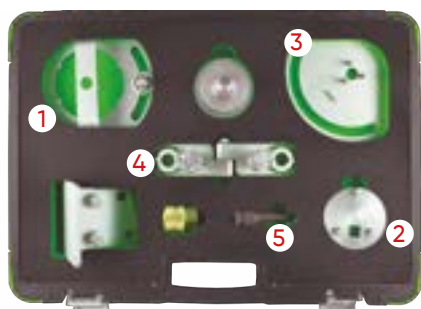

**MARCAS**

**VOLVO:** S60 (10-16), S80 (07-15), XC60 (08-15), XC70 (06-15), XC90 (10-14), V60 (10-15), V70 (10-15).  
**LAND ROVER:** Freelanders II (11-14).

**FERRAMENTAS OEM**

**VOLVO:** 999-7263 (3), 999-7264 (1), 999-7272 (5), 999-7257 (2), 999-7261 (4).  
**LAND ROVER:** 303-1225 (3), 303-1226 (1), 303-1219 (2), 303-1223 (4).

**CÓDIGOS DE MOTOR**

**3.0 Turbo:** B6304T2, B6304T4.  
**3.2:** B6324S, B6324S5.  
**3.2i6:** B6324S.

## CONJUNTO DE 6 FERRAMENTAS DE SINCRONIZAÇÃO DE MOTOR

**53775**

1.108,50€



diesel gasolina

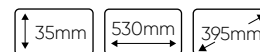

**53769** RENAULT / NISSAN / OPEL / VOLVO



**53770** FORD / SEAT / VOLKSWAGEN / MAZDA / VOLVO



**53771** FIAT / FORD / CITROËN / PEUGEOT



**53772** FORD / VAG / MAZDA / VOLVO



**53773** FIAT / ALFA / LANCIA / OPEL / SUZUKI / FORD



**53774** OPEL / CHEVROLET / SAAB / FIAT / LANCIA / SUZUKI / FORD



## GABINETE COM 7 GAVETAS COM KIT DE FERRAMENTAS DE AJUSTE DE SINCRONIZAÇÃO

**53951**

1.794,00€

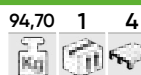

**53952**

1.794,00€



**53775**

1.108,50€

diesel  
benzina

### CONJUNTO DE 6 MÓDULOS DE SINCRONIZAÇÃO DE MOTOR





## CHAVE UNIVERSAL PARA ÁRVORE DE CAMES + ADAPTADORES

51340

38,00€

2,15 6 200



- Contém:  
1 Chave: Faixa de abertura: 40 mm min. - 235 mm máx. + Comprimento 540mm.  
4 jogos de 2 parafusos adaptadores de 4 medidas.  
1 jogo de 2 roscas de 1cm de diâmetro.



## EXTRATOR DE PINHÃO DE EIXO DO COMANDO FORD

53318

24,00€

0,4 20



diesel



MARCAS FORD

APLICÁVEL A MOTORES F8M, F8Q, S8U, S9U.

## CHAVES DE AJUSTE DO EIXO DE COMANDO VAG 1.8 / 2.0 TFSI

53323

9,50€

0,15 18 36



gasolina

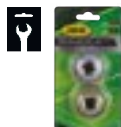

MARCAS AUDI: A3, A4, A5, Q5 1.8.  
VW: 2.0 corrente.

FERRAMENTAS OEM T10352, T10352/1.

CÓDIGOS DE MOTOR 1.8 / 2.0

## FERRAMENTA DE BLOQUEIO DE EIXO DE COMANDO GRUPO VAG

53320

12,00€

0,15 10 40



diesel

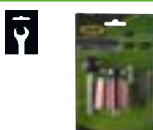

MARCAS SEAT: Alhambra, Altea, Arosa, Cordoba, Ibiza, Leon, Toledo 1.4/1.9/2.0 TDI.  
VW: Passat 1.9.  
AUDI: A4/A6 1.9.

FERRAMENTAS OEM T10008, T20102, T10100.



## KIT DE BLOQUEIO DE DISTRIBUIÇÃO VAG

52271

18,00€

0,43 5 40 320



MARCAS

AUDI: A2 1.4TDI (02-06), A3 1.9, 2.0TDI (02-08), A4 1.6TDI (02-05), A4 1.9, 2.0TDI (04-08), A6 1.9TDI (02-05).  
SEAT: Altea 1.9SDI/TDI (05-08), Leon 1.9, 2.0TDI (05-08), Toledo 1.9SDI/TDI (05-08).  
SKODA: Fabia 1.4TDI (03-06), Octavia II 2.0TDI (03-06)  
VW: Beetle 1.9TDI (02-08), Bora 1.9TDI (02-08), Fox 1.4TDI (02-08), Golf 1.9, 2.0TDI (02-08), Lupo 1.4TDI (02-08), Polo 1.4, 1.9TDI (02-08), Sharan 1.9TDI (02-08).

CÓDIGOS DE MOTOR

AUDI: AMF, ASZ, ATD, AVB, AVF, AWX, AXR, AZV, BHC, BKC, BKD, BKE, BLB, BMN, BNA, BPW, BRB, BR, BRD, BRE, BRF, BUY, BVA, BVF, BVG.  
SEAT: BJB, BKC, BLS, BMM, BXE  
SKODA: AMF, AZV, BKD  
VW: AJM, AMF, ANU, ARL, ASZ, ATD, AUY, AVB, AVF, AWX, AXR, BAY, BMS, BNM, BNV, BVWB

## KIT DE BLOQUEIO DA ÁRVORE DE CAMES

51489

12,00€

0,35 10 40 2.250



gasolina



- Fácil de usar para o bloqueio das polias da árvore de cames quando se leva a cabo a manutenção.

MARCAS

VW: Lupo 99, Polo 95, Caddy 96, Polo Classic, Variant 96, Beetle 1.4L 99, Golf 1.4L, 1.6L 98 y 1.4L, Bora, 1.6L 99.  
AUDI: A2.

FERRAMENTAS OEM

T10016.

CÓDIGOS DE MOTOR

1.4 / 1.6 16V



## BLOQUEADOR DE CAMBOTA LEVA E A/ CAMES RENAULT / NISSAN / DACIA / SUZUKI

51488

16,00€

0,25 5 100 2.250



- Passadores de segurança para o conjunto de árvore de cames e a cambota para Renault, motores diesel e de gasolina.  
- Conveniente para o bloqueio do motor durante a substituição ou manutenção do conjunto da árvore de cames.

MARCAS

RENAULT: Captur, Clio II, III, IV, Espace/Grand Espace III, IV, Fluence, Kadjar, Kangoo, Laguna I, II, III, Logan/Logan MCV, Megane I, II, III, IV, Modus/Grand Modus, Scenic/Grand Scenic I, II, III, IV, Twing II, Trafic II, Master II 1.5dCi & 1.9 dCi.  
DACIA: Dokker, Duster, Lodgy, Logan, Sandero 1.5dCi  
NISSAN: Almera, Cube, Juke, Kubistar, Micra, Note, NV200/Evalia, Primera, Tiida, Interstar, Primastar 1.5dCi & 1.9 dCi  
SUZUKI: Grand Vitara, Jimny 1.5DDiS & 1.9DDiS

FERRAMENTAS OEM

MOT1489, MOT1430, MOT1054.

CÓDIGOS DE MOTOR

K9K, F8Q, F9Q - Gasolina, Clio, R19, Laguna 1.8/2.0 F3R F3P



## KIT DE BLOQUEIO CITROEN/PEUGEOT 1.0/1.2 VTI

53875

1,85

4

125,00€



### MARCAS

VW: Golf, Touran  
AUDI: A3, A4

### FERRAMENTAS OEM

OEM T10134.

### CÓDIGOS DE MOTOR

1.4i turbo  
1.4 e 1.6 injeção direta de combustível  
1.9 / 2.0 SDI  
2.0 motores diesel Common Rail

## DESMONTADOR E TENSOR DE CORREIAS EN POLI-V

51927

0,65

5

640

25,00€



- Para montar-desmontar e extrair as novas correias em POLI-V facilmente.

- Adequado para o PSA e motores de Ford Fiesta 1.4/1.6, Citroën C4, Peugeot 307, Fiat Doblo, Dacia Logan.

- Ferramenta indispensável para uso profissional.

- Sem um ponto de agarre preciso, não é possível desmontar ou extrair as correias adequadas para este utensílio.



## TENSIÔMETRO PARA CORREIA DE TRANSMISSÃO

52616

0,35

10

40

800

42,00€



- Dois escalas ajustáveis (daN) com leitura dianteira e traseira.

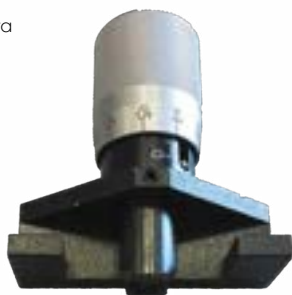

## FERRAMENTA DE SINCRONIZAÇÃO DE POLIAS VW / AUDI 2.5 TDI 32MM

53325

0,1

20

100

gasolina

7,50€



### MARCAS

AUDI: 100 ('91-), A6 (2.5 TDI) 2.3, 2.4, 2.5, 2.8, 2.9D TDI (1991-2003)  
VW: LT, Transporter

### CÓDIGOS DE MOTOR

AAB, AAT, ACU, ACV, AEL, AET, AGX, AHG, AHY, AJA, AJT, ANJ, APA, APL, AUF, AVT, AXG, AXL, AYC.

### FERRAMENTAS OEM

3355

## FERRAMENTA AJUSTE TENSÃO CORREIA VAG

53321

0,25

10

50

gasolina

10,50€

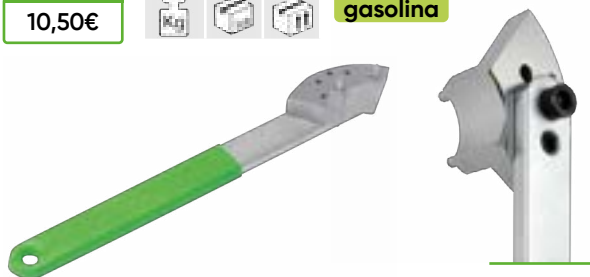

### MARCAS

AUDI: A4/1.8T/2.0 1999-2004 A6/1.8T 2002-2004 A4/3.0 (2002 - ), A6/3.0 (2002 - ), A8/7.0 (2003 - ).  
VW: Golf Passat 2.0 TDI DIESEL, Golf 88-97, Passat 92-97, VW T4/2.0 1992-2004.

### FERRAMENTAS OEM

T10020.

## FERRAMENTA RETENÇÃO BOMBA ANTICONGELANTE

53317

0,64

12

diesel

32,00€



- Usado para manter o motor na posição cronometrada durante a remoção / instalação da bomba de refrigeração.  
- Permite que a bomba seja substituída sem deslocar a corrente de distribuição

### MARCAS

OPEL 2.2 Corrente  
VAUXHALL 2.2 Corrente



## CHAVE 1/2 PARA CAMARA COMBUSTIÓN

52819

0,24

5

50

22,00€



1/2"

MERCEDES

58 DENTES



VÁRIOS

TANQUE DE ARMAZENAMENTO



242

BOMBAS DISPENSADORAS



244

PARA UREA AUS32



245

BOMBA DE EXTRAÇÃO



246

DRENAGEM DO OLEO



247

SERINGA



250

APARADEIRA PARA LÍQUIDOS



251

FUNILS



252



# ACESSÓRIOS LUBRIFICANTES





## TANQUE DE ARMAZENAMENTO DE TAMBOR

Tampa removível / Paleta fixa para derramamento / Remover os tambores antes de usar uma empilhadeira / Fácil transporte / Para uso com a maioria das empilhadeiras e paletizadores / Feita de polietileno (PE) de 100% recicláveis.

SUPORTA 400 KG

**52804**

337,50€



230L



1 TAMBOR VERTICAL

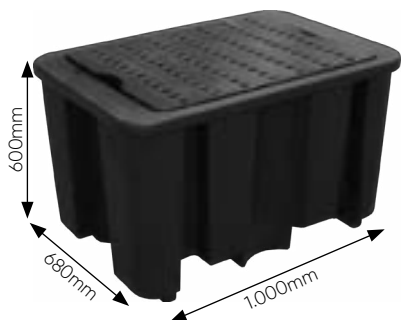

SUPORTA 650 KG

**52805**

422,50€



250L



2 TAMBORES VERTICAIS



NÃO ADEQUADO PARA PORTA PALETES. SUPORTA 1.250 KG

**52806**

739,00€



250L



4 TAMBORES VERTICAIS

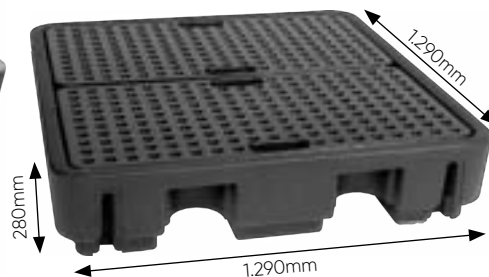

APROVADO DIBT

## TANQUE DE ARMAZENAMENTO DE TAMBOR ESPECIAL EUROPALETE 2 BIDÕES

**53214**

281,50€



- Para 2 bidões.
- Compatível com a europallet (1200 mm x 800 mm) e paletes plásticas com dimensões similares.
- Empilhável para o transporte e o armazenagem económico.
- Colocar a europallet directamente acima da cubeta para reduzir o custo.
- As paletes carregadas podem ser postas em/retiradas da cubeta com o sem grelha por carreta elevatória.
- Cubeta com uma altura baixa ideal para o trabalho
- Capacidade em linha o por acima das normas Europeias, Britânicas e Americanas.
- Pode ser manipulado por carreta elevatória dos 4 lados ou transpallet por 2 lados coando esteja vazio.
- Fabricado em polietileno - 100% reciclável.



## CONTAINER IBC 1.000L

**52807**

1.540,00€



- Empilhável, economiza espaço, inovador.
- Altura baixa (700mm) Para uma utilização mais fácil.
- Ampla área de trabalho (2,5 m<sup>2</sup>).
- Plataforma com furos para as mãos e orifícios de inspeção.
- Fácil transporte.
- Compatível com a maioria das empilhadeiras e pallets.
- PE 100% reciclável e resistente aos tays UV.

SUPORTA 2.500 KG



APROVADO DIBT

## CARRO PORTA BIDÕES

**50924**

- Apto para bidões de óleo de 200L.

**299,00€**



RODA GIRATÓRIA

## BRAÇADEIRA PARA TAMBORES (CAPACIDADE DE 500 KG.)

**53612**

4,75 1 50

**88,00€**



- Para lidar com bidão de óleo.
- Capacidade: 500kg
- Tipo de recolha vertical do bidão.
- Bidões de óleo especiais de 200L.



## CHAVE PLÁSTICA PARA BIDÕES

**52452**

0,12 6 60 1.080

**8,00€**



- Material: Nylon.
- Anti-chispa.
- Pontas em acabado de 3/4" e 2".
- Útil para bidões de 200L.



## TORNEIRA PARA BIDÃO DE 200L

**53078**

0,25 5 25 300

**18,00€**



- Permite o esvaziamento rápido de tambores de 200 litros.
- Adequado para água, todos os tipos de óleos, álcool ou cetona, bem como ácidos fracamente concentrados e líquidos levemente alcalinos.

- Material: PE.
- Junta de EPDM.
- Mola em aço inoxidável.



## TORNEIRA DE PLÁSTICO DE 3/4" PARA BIDÃO DE ÓLEO 200L

**53518**

0,05 10 500 3.000

**3,50€**



200L

- Adequado para todos os tipos de fluidos.
- 3/4" rosca externa.

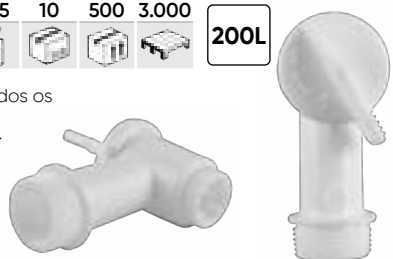

## TORNEIRA DE 3/4" PARA BIDÃO DE ÓLEO DE 200L

**52453**

0,19 5 100 1.000

**19,00€**



200L

- Torneira de segurança.
- Rosca de 3/4".
- Corpo de aleação.
- Junta de Nylon.
- Aplicações: Óleos, gasolina, diesel, queroseno, etc.
- Válido para Urea AUS32.



## ADAPTADOR DE ROSCA DE TAMBORES PLÁSTICOS

**13982**

0,05 100

**4,00€**



- Permite o ajuste e compensação de várias rosca de tanques, tambores e bombas.



## BOMBA MANUAL EXTRAÇÃO PLÁSTICA

**52329**

0,98 10 140

**34,50€**



- Para bidões de 25, 50, 200L.
- 350ml por caudal.
- Corpo e pistão de polipropileno.
- Cabo de plástico ABS.
- Aplicações: alcoóis, óleos, gasolina, diesel, queroseno, etc.
- Conducto de sucção: Comp. mínimo: 320mm. Comp. máximo: 900mm.



320-900mm

## BOMBA DE BOMBEAMENTO DE COMBUSTÍVEL DIESEL COM DOSADOR E INDICADOR (200-240 V)

53697

369,50€

14



1



- Tensão nominal: 200-240V.
- Potência nominal: 550W.
- Máx. vazão: 60 l/min.

- Comprimento do cabo: 2m.
- Comprimento da mangueira de sucção: 2m.
- Comprimento da mangueira de pressão: 4m.

COM PARADA AUTOMÁTICA

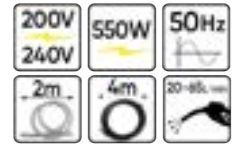

BOMBA

14607

8,6

2

164,50€

14

1



DOSADORL COM PARADA AUTOMÁTICA

14606

0,98

20

57,00€

14

1



INDICADOR DIESEL/ GASOLINA

14608

1,7

20

69,00€

14

1



MANGUEIRA PARA REMOÇÃO

14609

0,6

10

16,00€

14

1



MANGUEIRA PARA FORNECIMENTO

14610

2,4

5

36,50€

14

1

## BOMBAS DISPENSADORAS DE DIESEL COM PISTOLA

- Bomba de transferência de combustível portátil.
- Fácil de transportar: tamanho compacto com alça incorporada.

### ELÉTRICO

53610

242,50€

13



2



28



COM PARADA AUTOMÁTICA

- Eléctrico.
- Fornecido com pistola e mangueiras.

- Comprimento da mangueira de entrada: 2m.
- Comprimento da mangueira de saída: 4m.

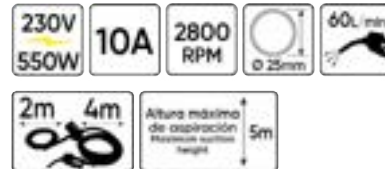

BOMBA

14607

8,6

2

164,50€

14

1

DOSADORL

14606

0,98

20

57,00€

14

1

MANGUEIRA PARA REMOÇÃO

14609

0,6

10

16,00€

14

1

MANGUEIRA PARA FORNECIMENTO

14610

2,4

5

36,50€

14

1

53609

180,00€

7,30



2



28



COM PARADA AUTOMÁTICA

- Comprimento da mangueira de entrada: 2m.
- Comprimento da mangueira de saída: 4m.

- Incorpora cabo longo com braçadeiras que permite uma fácil conexão com a bateria do veículo, ideal para aplicações agrícolas e industriais.
- Fornecido com pistola e mangueiras.
- Solução prática para reabastecer e transferir combustível / diesel quando apenas a bateria estiver disponível.



BOMBA

15553

107,50€

DOSADORL

14606

0,98

20

57,00€

14

1

MANGUEIRA PARA REMOÇÃO

14609

0,6

10

16,00€

14

1

MANGUEIRA PARA FORNECIMENTO

14610

2,4

5

36,50€

14

1



## TANQUE DE UREA AUS32 (75 L)

53644

18,15

1

4

948,00€



- Uma construção autónoma e totalmente móvel de 75 L com uma bomba de 12V (permite atingir o desempenho no nível de 10 L/min com a pressão operacional de 40PSI), man-gueira e válvula de fechamento automático.
- O tanque de polietileno que é resistente ao impacto, corrosão e UV.
- As rodas de grande diâmetro (200mm) permitem que sejam manobradas facilmente no terreno desigual.

1.040mm 440mm 520mm

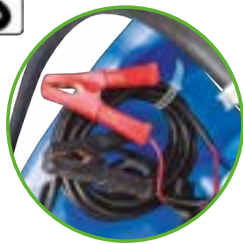

75L



## MEDIDOR DE FLUXO DIGITAL PARA BOMBA DE COMBUSTÍVEL

53699

0,3

20

63,05€



- Bateria incluída.
- Canal de entrada: BSPT 1/2".
- Fluxo: 1-50 l/min.



DIESEL



## BOMBA ELÉTRICA DE UREA AUS32

53645

3,10

4

24

199,00€



- Bomba de tambor elétrica projetada para meios à base de água, Urea AUS32 DEF e produtos químicos selecionados de tambores de metal de IBC de 205 L ou 1000-1250 L.
- Construção compacta e leve.
- Fusível incorporado para proteção contra sobrecarga e motor silencioso.
- Filtro de aço inoxidável embutido no tubo de sucção evitando que os contaminantes en-trem e causem danos.



INTERRUPTOR ON/OFF CONVENIENTE COM INDICADOR LED

850-1246mm

O TUBO DE SUÇÃO TELESCÓPICO ESTENDE-SE DE 850MM A 1245MM

O ADAPTADOR EMBUTIDO DE 2" + CONVERSOR DE ROSCA ADICIONAL PARA ADAPTADORES DE 2"



PISTOLA

15123

32,00€

MANGUEIRA 4M

14473

46,00€

ADAPTADOR DE ENTRADA PARA O TANQUE IBC

14703

13,00€

30mm

187mm

187mm

2" BSP



## BOMBA DE ÓLEO + MANGUEIRA COM TORNEIRA

**52601**

352,50€

9,1

2

30

200L

- Pressão bombagem: 5:1.
- Entrada Ar: 1/4".
- Saída Ar: 1/4".
- Pressão trabalho: 6-8 bar.
- Pressão Máx.: 8 bar.
- Consumo de Ar: 250 L/min.
- Capacidade relativa 6 bar: 18 L/min.
- Temperatura do óleo: -10~50°C.
- Viscosidade máxima: 240 SAE.
- Compr. do tubo: 950mm.



MANGUEIRA COM TORNEIRA PARA REF. 52601

**12056**

57,00€

1,71

61

## KIT BOMBA ÓLEO + MANGUEIRA + PISTOLA ÓLEO DIGITAL

**50935**

495,00€

10,7

1

20

200L

- Viscosidade máxima: 240 SAE.
- Compr. da mangueira: 2 m.
- Compr. do Tubo: 950 mm.
- Pressão Bombagem: 5:1.
- Capacidade relativa 6 bar: 18 L/min.
- Alcance de Temperatura do óleo: -10~50°C.
- Consumo de ar: 250 L/min.
- Pressão Bombagem: 5:1.
- Entrada de Ar: 1/4".
- Saída de Ar: 1/2".
- Pressão trabalho: 6-8 bar.
- Pressão Máx.: 8 bar.

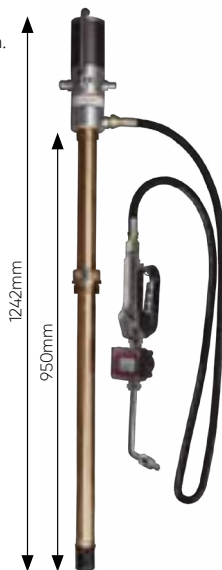

## BOMBA PARA BIDÃO DE ÓLEO

**50918**

299,00€

7,25

1

34

200L

- Pressão Bombagem: 5:1.
- Entrada Ar: 1/4".
- Saída Ar: 1/2".
- Pressão trabalho: 6 - 8 bar.
- Pressão Máx.: 8 bar.
- Consumo de Ar: 250 L/min.
- Capacidade relativa 6 bar: 18 L/min.
- Temperatura do óleo: -10~50°C.
- Viscosidade máxima: 240 SAE.
- Compr. do tubo: 950mm.

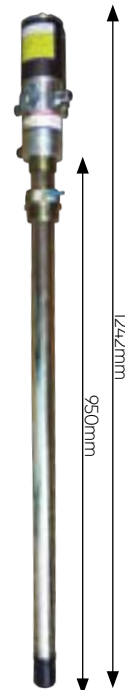

PORCA DE BIDÃO PARA REF. 50935 E 50918



**10767**

21,00€

0,28

90



**10925**

18,00€

0,67

90

## PISTOLA DE BOMBEAMENTO DE ÓLEO COM CAUDALÍMETRO DIGITAL

**50917**

228,00€

2,15

10

50

- Entrada de Ar: 1/2".
- Alcance de Caudal: 1-35 L/min.
- Pressão trabalho: 6 - 8 bar.
- Alcance de Temperatura do óleo: -10~60°C.
- Viscosidade máxima: 240 SAE.
- Pilha incluída.
- Peso: 1,4Kg.



PILHA DE RECAMBIO P/50917

**10000**

7,00€

2,1

10

80

## CARRO PORTA BIDÕES

**50924**

299,00€

- Apto para bidões de óleo de 200L.



31

1

7

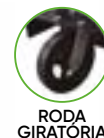

RODA GIRATORIA



## BOMBA DE ÓLEO MANUAL

**51253**

39,00€

465mm

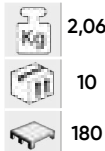

2,06

10

180

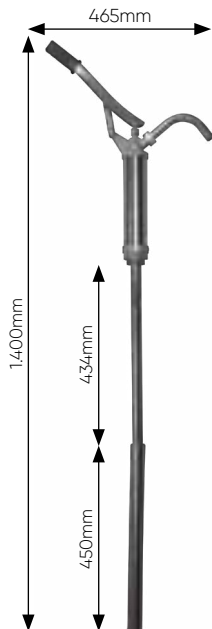

## ADAPTADOR DE ROSCA DE TAMBORES PLÁSTICOS

**13982**

4,00€

0,05

100

- Permite o ajuste e compensação de várias roscas de tanques, tambores e bombas.



## BOMBA MANUAL PARA EXTRAÇÃO

**52428**

39,00€

1,39

1

10

120



- Para bidões entre 50 e 200L.
- Caudal 400ml por impulso.
- Capacidade de caudal: 32 L x minut.
- Adaptador de boca de 2" incluído.
- Tubos de sucção de 101cm com entrada de 1 1/4" e saída de 1".
- Não permitido a: Ácidos fortes, lixívia, gasolina.
- Aplicações: óleos, lubrificantes, diesel, fluidos à base de óleo.
- Recomendado para: diluente de laca, líquido de travões, detergentes, glicerina, ácidos suaves fluidos à base de petróleo.

## DRENAGEM DO ÓLEO COM SISTEMA DE ASPIRAÇÃO

**53874**

**398,00€**



**90L**

**8-10 BAR**

### DESMANCHA DISPONÍVEL



Projetado para coletar e drenar o óleo do motor e da transmissão dos veículos.

- Pressão do ar de trabalho 8 ~ 10 bar
- Nível de vácuo: negativo 0 ~ 0,8 bar
- Volume do tanque: 70 l
- Volume do filtro de coleta 10 l
- Volume do copo de medição: 10 l
- Velocidade de sucção do óleo de acordo com o diâmetro da sonda: 0,8 l/min (Ø25x3,5 mm); 1 l/min (Ø6x4,5 mm); 1,6 l/min (Ø8x6,5 mm)
- Dimensões: 43x49x163 cm Meio: óleo do motor e óleo da transmissão
- Temperatura de óleo operacional recomendada: 40 ~ 60°C
- Com aspiração a vácuo.
- Sistema de medição pictórico.
- Grande tanque.
- Botão para controlar o uso.
- Rolos para fácil transporte.

REF.	CARACTERÍSTICAS	1	2	3	4	€
15018	Módulo de chaves para bujão de carter, 22pcs	1,45	-	10	480	46,00€
14937	Roda para colector de óleo 80l	0,30	-	14	-	9,50€
15282	Manômetro	0,20	-	20	-	15,00€
15283	Mangueira	0,40	-	20	-	27,50€
15305	Mangueira com válvula curvada	0,65	-	40	-	19,50€
15306	Mangueira para ligar o funil a um tanque com válvula de fechamento	0,35	-	20	-	27,50€
15307	Funil	2,10	-	10	40	39,55€
15310	Topo da válvula	0,05	-	20	-	11,50€
15311	Kit de encaixes	0,20	-	20	-	11,50€
15312	Encaixe para conexão de tanque e mangueira	0,10	5	40	-	11,50€
15318	Tubo de conexão	0,80	-	20	-	17,00€
15308	Pequena roda auto-orientante	0,35	-	40	-	7,00€
14014	Tubulação de substituição 4mm	0,02	-	100	-	6,00€
14015	Tubulação de substituição 6mm	0,05	-	100	-	6,00€
14016	Tubulação de substituição 8mm	0,05	-	100	-	6,00€
15550	Tubo de sucção de metal 6 mm	0,07	-	100	-	6,00€
15551	Tubo de sucção de metal 8 mm	0,08	-	100	-	6,00€



## DRENAGEM DO ÓLEO

**53873**

**325,00€**



**80L**

**1-3 BAR**

Projetado para coletar e drenar o óleo do motor e da transmissão dos veículos.

- Pressão do ar de trabalho 1-3 bar
- Volume do tanque: 70 l
- Volume do filtro de coleta 10 l
- Dimensões: 35x48x163 cm
- Meio: óleo do motor e óleo da transmissão
- Grande tanque.
- Botão para controlar o uso.
- Rolos para fácil transporte.
- Pode ser usado para óleos de alta temperatura (sem limitação).

### DESMANCHA DISPONÍVEL



REF.	CARACTERÍSTICAS	1	2	3	4	€
15018	Módulo de chaves para bujão de carter, 22pcs	1,45	-	10	480	46,00€
14937	Roda para colector de óleo 80l	0,30	-	14	-	9,50€
15305	Mangueira com válvula curvada	0,65	-	40	-	19,50€
15307	Funil	2,10	-	10	40	39,55€
15309	Tubo de conexão	0,75	-	20	-	17,00€
15312	Encaixe para conexão de tanque e mangueira	0,10	5	40	-	11,50€
15308	Pequena roda auto-orientante	0,35	-	40	-	7,00€





## BOMBA DE ASPIRAÇÃO DE ÓLEO - 12V

**53566**

**32,00€**



- O extrator de óleo é um dispositivo ideal para trocas de óleo rápidas e limpas.
- Funciona ligando os grampos à bateria do carro de 12V.
- O óleo é simplesmente retirado do motor através do orifício do medidor de óleo.
- Use o extrator apenas para óleo de motor, óleo diesel ou óleo de aquecimento.

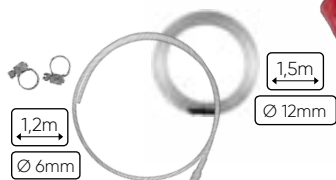
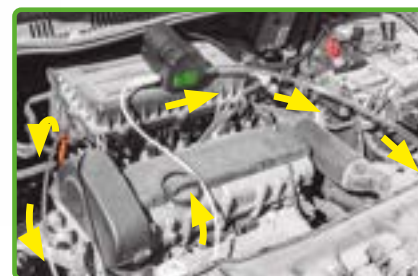

## KIT DE EXTRAÇÃO DE ÓLEO E COMBUSTÍVEL

**53627**

**22,50€**

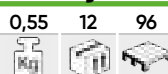

- O dispositivo é projetado e fabricado para a remoção rápida de óleo, combustível e óleo de transmissão/diferencial de tanques de geradores, lavadoras de alta pressão, compressores pneumáticos, tratores de jardim ou veículos todo-terreno.



## COMPROVADOR DE ANTICONGELANTE

**53453**

**6,00€**

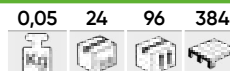

-43°C - 131°C



## BOMBA DE MASSA NEUMÁTICA

**50751**

**38,00€**

- Pressão: 30Mpa

500ml



## PISTOLA DE LUBRIFICAÇÃO COMPACTA

**53849**

**14,50€**

0,30 40

80cc

- Esta pistola engrasadora é perfeita para barcos, motos, bicicletas elétricas, bicicletas ou outro tipo de máquina ou equipamento que precise lubrificação.
- Muito confortável para trabalhar só com uma mão.

- Boca 0.5mm.
- Tampa removível com tubo 50°.
- Pressão de trabalho 1000 psi.
- Bomba de carga: impulso por mola.



## PISTOLA GRAXEIRA MANUAL COM TUBO FLEXÍVEL

**50852**

**24,50€**



- Ø 14mm exterior.
- Ø 5mm interior.
- Pressão: 20Mpa.



500ml

## BOMBA MANUAL PARA SISTEMAS DE TRANSMISSÕES COM ADAPTADORES

52797

227,50€

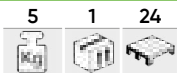

- Capacidade: 7,5L.
- Descarga: 80cc ciclo.
- Alcance de viscosidade até SAE 140.
- Suporta enchimento e esvaziamento

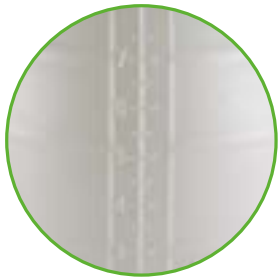

BOMBA DE ENCHIMENTO  
SISTEMA TRANSMISSÃO SEM  
ACESSÓRIOS REF. 52797

13234

224,50€



+



## SET DE ADAPTADORES PARA O SISTEMA DE BOMBA DE TRANSMISSÃO

12044

147,00€

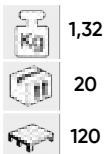

101  
FORD 1/8 - 27 (NPT)

102  
UNIVERSAL, BMW,  
HONDA, NISSAN, etc

103  
VW/AUDI, SKODA

104  
VW/AUDI, PORSCHE

105  
VW/AUDI, MINI  
COOPER M10x1.0

106  
VW/AUDI DSG M24x1.5

107  
VW/AUDI CVT M22x1.5

108  
MERCEDES M12x1.5

109  
VW/SKODA M18x1.5

110  
AUDI/VW, SKODA,  
M30x1.5

111  
UNIVERSAL FLEXIBLE  
300mm, HONDA,  
HYUNDAI, KIA, etc.

112  
VOLVO 5/16 - 24  
(UNF)

113  
TOYOTA, LEXUS  
M18x1.0

114  
NISSAN, INFINITY M8x1.0

115  
ATF - ADAPTER  
VW PASSAT



15  
PCS

## BOMBA INJECTOR DIESEL

52801

24,00€



- Durante a substituição da bomba de injeção, filtros ou outras partes, impede e retracção do combustível para o depósito.
- Após a montagem de peças para substituir bomba permite bombear combustível para linha de injeção.



## BOMBA MANUAL REMOÇÃO GASOIL

52789

15,20€



- Mangueira 90cm longo em cada extremidade.



## ÇARRETEL DE MANGUEIRA PARA ÓLEO BOCA DE 1/2"

50797

26,6

1

14

490,00€



À base de óleo / bobina  
Comprimento da mangueira: 15 + 1 m  
Máx. pressão de trabalho: 2.450 psi  
Entrada de ar: 1/2" BSPT (rosca cônica padrão britânico)  
Saída de ar: 1/2", rosca cônica padrão britânico  
Material: aço



15m

160 BAR

## SERINGA TRANSPARENTE

52498

0,86

6

126

1.500ml

61,50€



- Fabricada em polipropileno.
- Corpo transparente.
- Apta para usar em óleos de transmissão e diferenciais.
- Resistente a líquido de travões e anticongelantes.

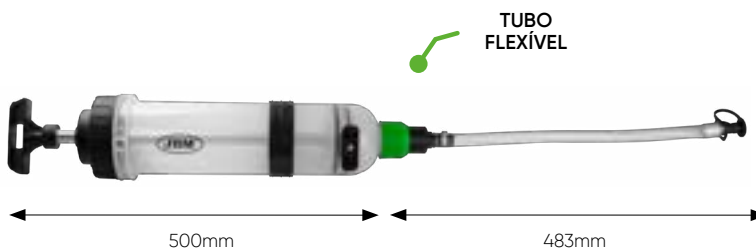

TUBO FLEXÍVEL

500mm

483mm



DOS O-RINGS PARA REF. 52498

0,03

50

150

11867

9,00€

Icons representing weight, volume, and quantity.

52628

0,3

5

20

450

200ml

26,50€



- Para fluido de freio.
- Conector rápido na ponta.

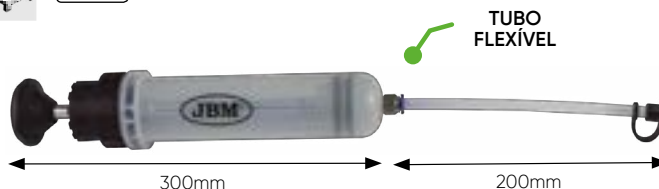

TUBO FLEXÍVEL

300mm

200mm



## SERINGA DE SUÇÃO DE ÓLEO

51928

0,82

5

20

360

500ml

13,00€



CRO-MADO

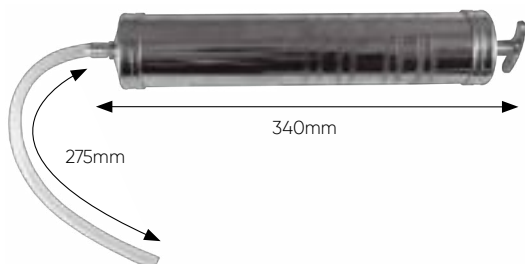

275mm

340mm



## ACOPLADOR DE LUBRIFICAÇÃO DE LIBERAÇÃO RÁPIDA

53592

0,15

25

100

19,60€



Recomenda-se usá-lo com as pistolas graxeras JBM ref. 50751 e 50852, embora seja adequado para uso na maioria das pistolas.

- Design ergonómico.
- Fácil de manusear: faz que acoplar e o desacoplar seja realizado sem esforço e economizando tempo de trabalho.
- A válvula de retenção integrada permite que a unidade seja facilmente desconectada a pressões de até 15.000 PSI (1.034 bar).
- Conexão integrada de 1/8 NPT.



Ø 14mm

Ø 10mm

- 3 mandíbulas endurecidas resistentes a altas pressões sem deformação.





# DISPOSITIVO DE TROCA DE ÓLEO DE TRANSMISSÃO AUTOMÁTICA

**54050**

**980,00€**

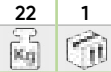

Permite que você troque o óleo da transmissão no modo automático.

- Fonte de alimentação: 12 V (bateria de carro)
- Potência da bomba: 70W
- Diâmetro do medidor de pressão de óleo: 70 mm (ambos os medidores de pressão de óleo)
- Faixa de medição do medidor de óleo: 0-10 bar (0-150 psi)
- Volume do tanque de óleo fresco: 30 l
- Capacidade do tanque de óleo residual: 30 l

Completo:

- 1 dispositivo para troca e lavagem
- 1 conjunto de adaptadores com 37 adaptadores de conexão/adaptadores de mangueira
- 1 mangueira de conexão vermelha com engate rápido, comprimento de 250 mm, diâmetro de 12,5 mm (1/2 pol.), máx. 20 bar (300 psi)
- 1 mangueira de conexão preta com engate rápido, comprimento de 250 mm, diâmetro de 12,5 mm (1/2 pol.), máx. 20 bar (300 psi)



O conjunto de entrega inclui uma caixa com adaptadores para diferentes marcas de automóveis (Volkswagen, BMW, Land Rover, Ford, Mercedes, Buick).

PINÇAS DE BATERIA DE 12V

XXXXXXXXXX  
XXXXXXXXXX

ELEMENTO DE FILTRO

**15539**

**103,50€**



**15542**

**45,00€**



## REFRATÔMETRO PARA ÁLCOOL

**50731**

**68,00€**



## REFRATÔMETRO UNIVERSAL

**52963**

**48,00€**



UREA AUS32

- Etileno glicol: -50°C ~ -0°C.
- Propileno glicol: -50°C ~ -0°C.
- Fluido de limpeza: -40°C ~ -0°C.
- UREA AUS32: 30% ~ 35%.
- Fluido de bateria: 1.100 ~ 1.400 sg/l.



## RECOLHEDORES PVC

Saída lateral para esvaziar / Com asa de agarrar / PVC muito resistente.

### DE ANTICONGELANTE

**53215**

**18,00€**



**18L**

- Medidas:  
Comprimento: 185cm / Diâmetro: 380mm.



### DE ÓLEO

**53144**

**18,00€**



**18L**

- Medidas:  
Comprimento: 185cm / Diâmetro: 380mm.



## BANDEJA DE ÓLEO 8L

**54051**

**50,50€**

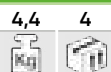

110mm 600mm 330mm

**8L**

**PE**



## APARADEIRA DE AÇO PARA LÍQUIDOS

**51356**  
68,00€

2,39 5 40  
23 L 110mm 400mm 600mm



## GALHETAS DE ÓLEO 250ml

**52243**  
7,50€

0,17 5 60 720  
250ml



## JARRO COM PESCOÇO FLEXÍVEL

**52991**  
10,50€

0,16  
20  
240

2L

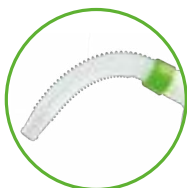

**52992**  
18,00€

0,36  
8  
96

5L



## GALHETAS DE ÓLEO 500ml

**52242**  
12,00€

0,28 10 60 480  
500ml



## FUNIL PARA BIDÃO DE 200L COM TAMP E FILTRO

**53187**  
39,00€

0,75 1 18 54  
4,5L



## JOGO DE 3 FUNILS

**53188**  
7,00€

0,15 24 288

Ø 90mm  
130mm  
180mm



## FUNIL COM FILTRO

**52391**  
5,00€

0,09  
5  
20  
400



950ml  
140 x 15mm

## KIT 2 FONILES MINI

**52392**  
5,00€

0,07 100 800



5,5 x 13 / 4,5 x 13mm

## FUNIL COM TUBO FLEXÍVEL

**53198**  
9,50€

0,15 24 168

Ø 180mm

1,89L



MACACO HIDRÁULICO



SOLLEVATORE A BOTTIGLIA



CAVALETE



PORTA RODAS



PRENSAS



GRUAS



SUPORTES PARA MOTORES



PARA MOTAS



PORTA PALETES



254

256

257

259

260

261

262

263

264



# FERRAMENTAS HIDRÁULICAS





## MACACO HIDRÁULICO DE RODAS - SISTEMA RÁPIDO

**53725**

298,00€



CAÇOLETA COM PROTEÇÃO DE BORRACHA

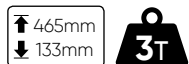

RODAS DE NYLON



PISTÃO HIDRÁULICO

**14709**

121,50€

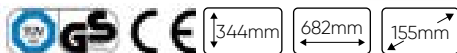

CUMPRE COM: EN 1494:2001

## MACACO HIDRÁULICO COM ALAVANCA DE ELEVÇÃO

PISTÃO DUPLO

**53422**

368,00€



CAÇOLETA COM PROTEÇÃO DE BORRACHA

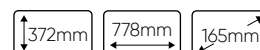

ALAVANCA DE ELEVÇÃO

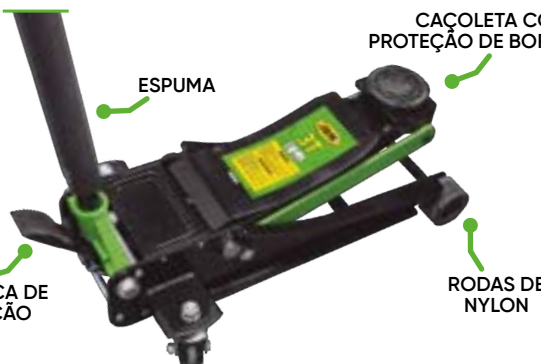

RODAS DE NYLON

RODA GIRATÓRIA PARA REF. 53422

**14071** 25  
21,50€

RODA FIXA PARA REF. 53422

**14072** 25  
21,50€

PISTÃO PARA REF. 53422

**14073** 25  
128,00€

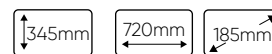

PISTÃO HIDRÁULICO PARA MACACO REF. 53112

**13853**  
122,00€

**53112**

299,00€

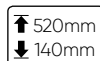

RÁPIDA ASCENSÃO



COBERTURA DE BORRACHA PARA MACACO NO CARRINHO. REF. 53112

0,13 5 20 **13836**  
9,00€

## MACACO HIDRÁULICO DE RODAS ESPECIAL CARROS BAIXOS

**50816**

88,00€

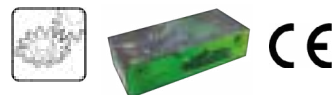
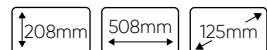
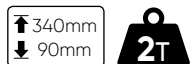

PISTÃO HIDRÁULICO PARA REF. 50816

**14708** 3 1  
59,00€

PISTÃO DUPLO

**53421**

314,00€

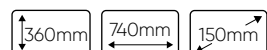

RODAS DE NYLON



CAÇOLETA COM PROTEÇÃO DE BORRACHA

ESPUMA

RODA GIRATÓRIA PARA REF. 53421

**14068** 50  
13,00€

PISTÃO PARA REF. 53421

**14070** 4  
115,50€

RODA FIXA PARA REF. 53421

**14069** 50  
13,00€

# MACACO HIDRÁULICO DE RODAS

**50818**

279,00€

37,5 1 18

346mm 685mm 180mm

495mm 133mm **3,5T**



**CE** EN 1494:2001



ELEMENTO DE BORRACHA PARA PLACA PARA REF. 50818

**14615** 0,05 100  
9,50€

PISTÃO SUBSTITUIÇÃO PARA REF. 50818

**10768** 6,43 1  
112,50€

CAZOLETA DE APOYO PARA REF. 50818

**10769** 1  
21,00€

TORNILLO DE SUJECIÓN LATERAL PARA REF. 50818

**10639** 0,34 5  
10,90€

MUELLE CRICK PARA REF. 50818

**10770** 0,05  
6,00€

**53968**

49,00€

5,80 1 90

205mm 490mm 140mm

300mm 130mm **2T**

**CE** EN 1494:2001



**50815**

88,00€

10,6 1 56

205mm 490mm 140mm

355mm 130mm **2T**



**CE**

EM CAIXA PLÁSTICA

**51895**

99,00€

11,5 1 42

205mm 490mm 140mm

355mm 130mm **2T**



**CE**



PISTÃO HIDRÁULICO PARA REF. 50815

**11939** 6 5  
62,50€

PISTÃO HIDRÁULICO PARA REF. 51895

**11939** 6 5  
62,50€



### MACACO TIPO GARRAFA 20T

**50823**  
98,00€

10 2 96  
↑ 452mm  
↓ 242mm

**20T**



CE

### MACACO TIPO GARRAFA 20T CARROS BAIXOS

**50824**  
93,50€

8,35 2 96  
↑ 335mm  
↓ 190mm

**20T**



CE

### MACACO TIPO GARRAFA 30T

**50825**  
154,00€

13,76 2 72  
↑ 465mm  
↓ 285mm

**30T**



CE

### MACACO TIPO GARRAFA 2-15T

**50819**  
28,00€

2,43 1 288  
↑ 345mm  
↓ 181mm

**2T**

↑ 345mm  
↓ 181mm

**50820**  
34,50€

3,22 6 300  
↑ 372mm  
↓ 194mm

**3T**

↑ 372mm  
↓ 194mm

**50821**  
47,00€

4,22 5 200  
↑ 413mm  
↓ 216mm

**5T**

↑ 413mm  
↓ 216mm

**50822**  
61,00€

5,79 4 160  
↑ 460mm  
↓ 230mm

**10T**

↑ 460mm  
↓ 230mm

**52304**  
84,00€

7,59 2 144  
↑ 365mm  
↓ 225mm

**15T**

↑ 365mm  
↓ 225mm



CE

### MACACO TIPO GARRAFA COM CAIXA PLÁSTICA 2-5T

**51905**  
34,50€

2,76 6 144  
↑ 340mm  
↓ 185mm

**2T**

↑ 340mm  
↓ 185mm

**51906**  
40,00€

3,58 4 144  
↑ 385mm  
↓ 195mm

**3T**

↑ 385mm  
↓ 195mm

**51907**  
50,00€

4,74 4 96  
↑ 450mm  
↓ 215mm

**5T**

↑ 450mm  
↓ 215mm



CE



## CONJUNTO DE 2 PREGUIÇAS

**53779**  
45,00€

5,05 1 72

↑ 430mm  
↓ 290mm

**2**  
PCS

**3T**

**53845**  
88,00€

9,25 1 30

↑ 610mm  
↓ 370mm

**6T**



## MACACO DE TESOURA

**53218**  
24,00€

2,5 6 216

**1,5T**



- Adequado para todos os carros.

## ALUMÍNIO 3T CARRINHO

**53200**  
69,00€

4,7 1 72

↑ 385mm  
↓ 245mm  
**3T**



## JACK ELEVADOR 3T

**53895**  
111,50€

9,15 1 42

↑ 330mm  
↓ 130mm

↑ 510mm

**53896**  
139,00€

11,6 1 28

↑ 645mm  
↓ 130mm

↑ 840mm

**53897**  
168,00€

13,9 1 21

↑ 1045mm  
↓ 130mm

↑ 1220mm

**53898**  
195,00€

13,9 1 21

↑ 1320mm  
↓ 130mm

↑ 1520mm

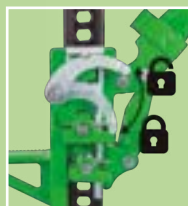

- Material: aço 45

**3T**

O dispositivo foi projetado para levantar veículos pesados como veículos todo terreno, caminhões e tratores, bem como para puxar, prender e rebocar.

Perfeito para off-road, fácil de operar, fácil de transportar e ótimo para todos os veículos em qualquer terreno.



SUPORE DE MONTAGEM DE RODA

**15093** 3,65 1 50  
82,50€

↑ 175mm

Projetado para prender com segurança o macaco de cremalheira no suporte externo da roda sobresolente 4x4 quando mover fora de estrada. Se encaixa na maioria dos veículos graças à base ajustável.



SUPORE DO MACACO

**15094** 1,35 5 140  
167,00€

↑ 293mm

Projetado para fornecer estabilidade e evitar que o macaco afunde em solo macio, aumentando a área de suporte.



RETENTOR DA ALÇA

**15095** 0,10 50  
19,00€

↑ 125mm

Projetado para proteger a alça do macaco durante o transporte.



DISPOSITIVO PARA ELEVAÇÃO POR RODA

**15096** 2 10 560  
87,00€

↑ 340mm

Projetado para levantar o veículo diretamente pela roda quando uma elevação alta é necessária.

## MACACO HIDRÁULICO DE FOSSA TELESCÓPICA 0,5T

**54001**

**285,00€**

32,7

1

4

↑1.900mm  
↓1.100mm

900mm

**500**  
KG

- Óleo sae 40.
- De construção sólida e sistema hidráulico de alta qualidade.
- Com pedal para uso silencioso e rápido.

### JOGO DE 4 RODAS

**15526**

3,5

50

**47,50€**

### PISTÃO SUBSTITUIÇÃO

**15527**

16

1

**276,00€**

### SUPORTE DE DUPLA POSIÇÃO

**15528**

2

50

**39,00€**

### 2 POSIÇÕES



COM VÁLVULA DE SEGURANÇA



1100mm

1900mm

## MACACO HIDRÁULICO DE FOSSA TELESCÓPICA

**50830**

**560,00€**

52,5

1

6

↑1.740mm  
↓850mm

- Com empunhadura
- Rápido
- Pistão duplo



## MACACO HIDRÁULICO DE FOSSA TELESCÓPICA 0,5T

**53161**

**298,00€**

32,7

1

4

↑1.910mm  
↓1.130mm

900mm

**500**  
KG

- Óleo sae 40.
- De construção sólida e sistema hidráulico de alta qualidade.
- Com pedal para uso silencioso e rápido.
- 5 Rodas para uma maior estabilidade.



### 2 POSIÇÕES



1130mm

1910mm

CE



### SUPORTE DE DUPLA POSIÇÃO PARA 50830

**14929**

1,95

10

**21,50€**

### PISTÃO SUBSTITUIÇÃO PARA REF. 50830

**12046**

**385,00€**



### ALMOFADA PARA REF. 53161

**14182**

1,95

10

100

800

**21,00€**



### PISTÃO SUBSTITUIÇÃO PARA REF. 53161

**13892**

1,95

2

**195,50€**



### ESFERA DE AÇO PARA REF. 53161

**14329**

**0,50€**



### SUPORTE DE DUPLA POSIÇÃO PARA 50830

**14929**

1,95

10

**21,50€**

Conveniente para armazenar instrumentos adquiridos separadamente.

Conveniente para armazenar instrumentos adquiridos separadamente.

## PORTA RODAS HIDRÁULICO

51901

999,00€



- Comprimento: 1040 mm
- Largura: 1090 mm
- Altura: 890 mm
- Faixa de elevação: 50-100 mm
- Máx. diâmetro da roda: 1320 mm



## PORTA RODAS HIDRÁULICO

52241

1.690,00€



- Carga útil: 1,5 t
- Faixa de elevação: 0-770 mm
- Comprimento total: 1270 mm
- Largura total: 990 mm
- Altura total: 1340 mm
- Diâmetro máximo da roda: 2200 mm (86")
- Diâmetro mínimo da roda: 1000 mm (39")
- Largura máxima da roda: 800 mm



AS RODAS NÃO DEIXAM MARCAS NA SUPERFÍCIE DEVIDO AO USO DE REVESTIMENTO DE PU RESISTENTE AO DESGASTE



O DESIGN FORNECE UM GANCHO SUPERIOR PARA ESTABILIZAÇÃO DURANTE O TRANSPORTE

## DOBRADORA DE TUBOS

50835

290,00€

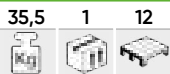

PARA UTILIZAÇÃO HORIZONTAL E VERTICAL

- Dobra tubos até 2" (50mm).
- Construção de aço.
- Barra de flexão ajustáveis.
- Pressão: 0,75 - 0,75mpa.
- Tamanho cunhas 1/2", 3/4", 1", 1-1/4", 1-1/2", 2".



680mm

585mm

195mm

PISTÃO

13870 6,70 1  
82,00€

CONJUNTO DE CARIMBOS FLEXÍVEIS 6 PÇS

15255 8,75 1  
113,50€





## PRENSA HIDRÁULICA 30 TON

**53684** 206 1  
**1.880,00€**

- Curso lateral (mm): 200.
- Percurso: 150mm.
- Accionado manual e com pé.
- Capacidade (T): 30.
- Curso (mm): 160.
- Faixa operacional (mm): 166-1126.
- Largura do assento (mm): 540.

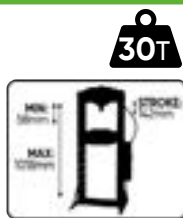

ACCIONADO MANUAL E COM PÉ

1838mm

750mm

780mm



PISTÃO COM DESLOCAMENTO HORIZONTAL



GUINCHO MANUAL PARA AJUSTAR A ALTURA DA MESA DE TRABALHO

## PRENSA HIDRÁULICA 20 TON

**53590** 114,50 1 9  
**1.190,00€**

- Capacidade (T): 20.
- Curso (mm): 145.
- Faixa operacional (mm): 58-1018.
- Largura do assento (mm): 540.
- Largura interior (mm): 536.
- Curso lateral (mm): 180.

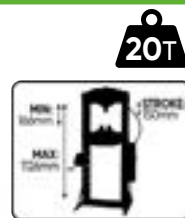

PISTÃO COM DESLOCAMENTO HORIZONTAL

1663mm

760mm

600mm



PISTÃO COM DESLOCAMENTO HORIZONTAL

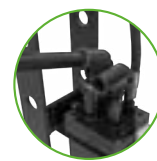

2 VELOCIDADES



CERCA DE GRADE  
**14616**  
 95,90€

PISTÃO  
**15044**  
 259,00€

MANÔMETRO  
**15046**  
 46,50€

ALAVANCA  
**15048**  
 5,00€

CERCA DE GRADE  
**14616**  
 95,90€

PISTÃO  
**15043**  
 194,50€

MANÔMETRO  
**15047**  
 46,50€

ALAVANCA  
**15048**  
 5,00€

BOMBA  
**14639**  
 195,00€

## BLOCO DE APOIA PARA PRENSA HIDRÁULICA

**52999** 7,6 2 120  
**168,00€**

BLOCO GRANDE

200mm 250mm 40mm

BLOCO PEQUENO

70mm 200mm 40mm

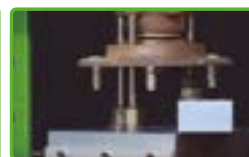
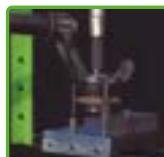

## COMPRESSOR MOLAS PARA AMORTECEDORES

**50827**  
**387,00€**

32,45 1 18

830mm 350mm 190mm

- Capacidade: 1T (2200 lbs)
- Diâmetro da mola comprimida: 200mm
- Comprimento de compressão: 200-500mm

1T

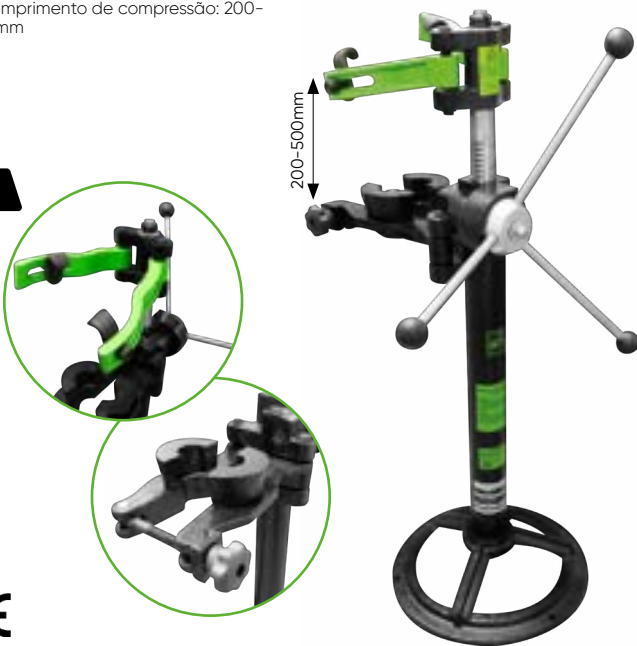

CE

## GRUA DE 1T DROBRÁVEL

**52985**  
**598,00€**

74 1 16

(Min./Max.): 82/105cm



1T

**PISTÃO DE REPOSIÇÃO PARA REF. 52985**  
**13672** 0,02 200  
220,00€

**ANEL DE VEDAÇÃO DO PISTÃO - REF. 52985**  
**14589** 100  
2,50€

## SUPOORTE ALINHADOR DE MOTOR

**50631**  
**68,00€**

6,3 1 98

750 KG

GRUA NÃO INCLUIDO.



CE

IVA não incluído

## COMPRESSOR MOLAS PARA AMORTECEDORES 1T

**53742**  
**999,00€**

66,50 1 6

1410mm 690mm 560mm

**1T** FONTE DE ALIMENTAÇÃO PNEUMÁTICA

- Capacidade de carga: 1000 kg
- Máx. comprimento de trabalho: 450 mm
- Curso do cilindro: 420 mm
- Diâmetro da mola: Ø102-165mm
- Direção do enrolamento: sentido horário
- Princípio de funcionamento: pneumático
- Pressão do ar: 6,5-9 bar (94,27-130,53 psi / 0,65-0,9 MPa)
- Modo de operação: pedal de pé

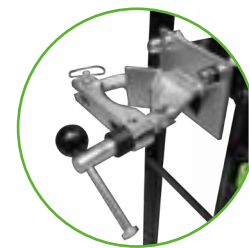

## GRUA DE 2T DROBRÁVEL

**50831**  
**460,00€**

81,4 1 20

1460mm 1060mm 1750mm

Altitude: 1'80m (2T) - 2,19m (1/2T)

- Dimensão fexada: 800 x 680 x 1.600mm.
- Capacidade: Posição 1: 2T - 80mm. Posição 2: 1½T - 255mm. Posição 3: 1T - 425mm. Posição 4: ½T - 610mm.

2T 2.620mm 60mm

CE



**RODAS GIRATÓRIAS PARA REF. 50831**  
**12032** 6  
7,50€

**PISTÃO SUBSTITUIÇÃO PARA REF. 50831**  
**14090** 10,30 1  
103,00€

**JOGO DE PARAFUSOS PARA A REF. 50831**  
**11323** 2,04 1  
16,00€

## SUPORE PARA MOTORES

**50840**

20,45

1

35

1750mm

**500 KG**

144,00€



ENGATE E MANIVELA  
PARA REF. 50840

**51452**

3,43

1

69,00€



**53682**

15,45

1

36

1500mm

**500 KG**

129,00€



CE

CE

## SUPORE DE MOTOR UNIVERSAL

**52055**

10

1

40

129,00€



- Adaptável a todo tipo de carros e carrinhas.
- Ideal para a troca da correia de distribuição, das correias auxiliares, ou caixa de velocidades.
- Suporte ideal de trabalho quando se retira o sub-chassis.
- Rápida colocação, com necessidade de um só operário.
- Colocação e acesso pela parte inferior.
- Peça perpendicular com ângulo giratório e ajustável a qualquer altura da barra longitudinal.
- Altura dos ganchos ajustável com 360° de rotação.
- Platina plástica de apoio para evitar o movimento do ponto de apoio da barra.



**500 KG**



CE

## SUPORE PARA MOTORES

**50836**

18,15

1

36

148,00€



**340 KG**

850mm

900mm

800mm



**50838**

43,9

1

12

299,00€



**900 KG**

900mm

1100mm

900mm

- Dimensão fexada: 100 x 50 x 44cm.



CE

## ELEVADOR DE MOTAS

**53969**

6

1

32

96,00€



**150 KG**

400mm  
300mm

328mm

293mm

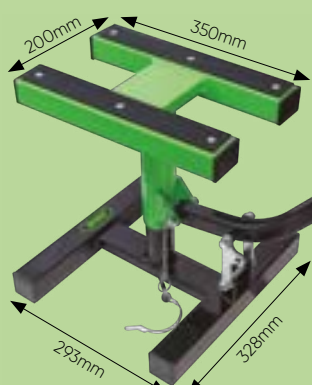

CE

## MESA PARA MOTAS

**52692**

13,5

1

50

129,00€



**500 KG**

400mm  
95mm

- Acionamento com chave de 21mm.



CE



## MESA HIDRÁULICA 360KG

53246

1.144,00€

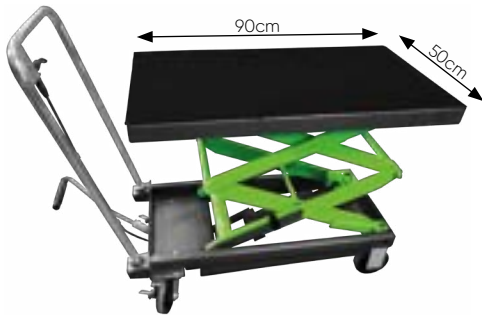

360  
KG

↑ 1.350mm  
↓ 370mm

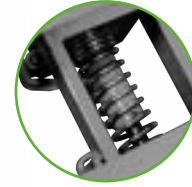

## ELEVADOR DE MOTAS

50630

599,00€



400  
KG

↑ 780mm  
↓ 290mm

↑ 480mm  
← 840mm



CE

## MESA HIDRÁULICA PARA MOTAS

50911

1.245,00€



↑ 780mm  
↓ 205mm

365  
KG

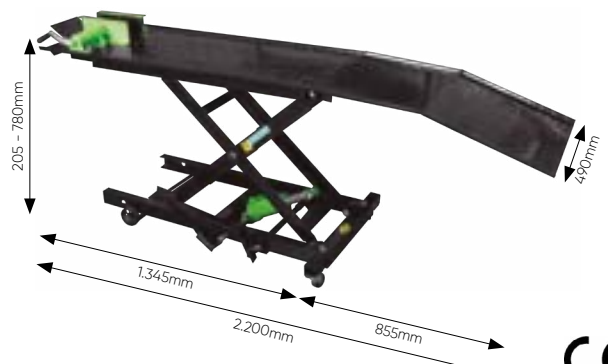

CE

PISTÃO SUBSTITUIÇÃO  
PARA REF. 50630

10993

8,80 1

116,55€



PISTÃO DE SUBSTITUIÇÃO  
PARA REF. 50630

11950

0,03 1

18,00€



CONJUNTO DE 2 RODAS  
COM TRAVÃO PARA 50911

14706

0,63 25

8,90€



PISTÃO SUBSTITUIÇÃO  
PARA REF. 50911

14727

8,1 1

108,00€



## MESA HIDRÁULICA PARA MOTAS

51750

299,00€

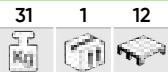

135  
KG

↑ 890mm  
↓ 340mm

↑ 500mm  
← 450mm  
↓ 340mm

CE



## MACACO ELEVAÇÃO QUAD

53423

199,00€



↑ 790mm  
← 370mm  
↓ 330mm

↑ 368mm  
↓ 118mm

680  
KG



ALAVANCA DE  
ELEVAÇÃO

PISTÃO SUBSTITUIÇÃO  
PARA REF. 53423

4,60 3

14291

86,50€

RODAS DE  
NYLON

## SET DE 2 RAMPA PARA ELEVAR 1T

52845

199,00€



2 PCS

- Útil para apresentar veículos a exposição, bem como para trabalhos de manutenção a parte inferior do veículo.

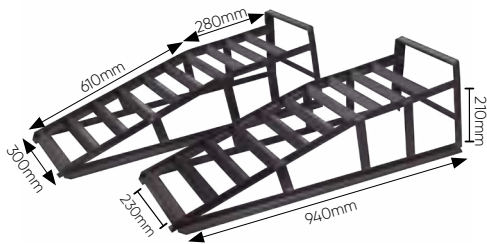

## SUPOORTE ELEVADOR DE MOTAS

FRENTE

52514

94,00€



200 KG



TRASEIRO

51751

125,50€



200 KG



APOIOS PARA SUPORTE DE MOTAS

PLANOS (x2)

10671

15,20€



REDONDOS (x2)

11892

12,50€



## PORTA CARROS HIDRÁULICO 680Kg

50839

224,00€



- Comprimento plástico preto das extremidades: 300mm.  
- Comprimento com rodas: 600mm.



PISTÃO PARA REF. 50839

15085

156,00€



RODAS PARA REF. 50839

12889

12,00€



680 KG



## CARRO TRANSPORTADOR ESPECIAL CHAPEIROS

50923

390,00€

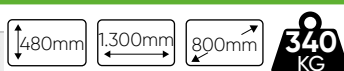

- Separação de 0 a 110 cm.

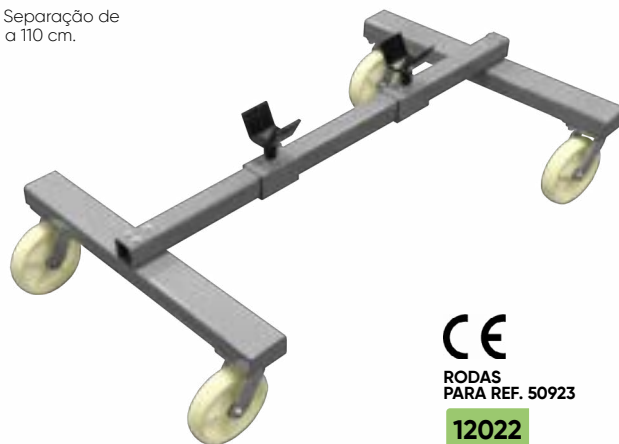

RODAS PARA REF. 50923

12022

33,70€

## PORTA PALETES MANUAL ELEVACÃO RÁPIDA

53880

598,00€



2,5T

- Capacidade de levantamento: 2500kg  
- Comprimento do empurrador: 1150mm  
- Alça: Quadrado, emborrachado  
- Volante (giratório): PU(200x50mm)  
- Roda fixa: Duplo, PU (80x70 mm)  
- Min. altura de forquilha: 85mm  
- Máx. altura de forquilha: 200mm  
- Número de cursos do pistão da bomba: 8



AÇÃO RÁPIDA (AÇO FUNDIDO)

CONJUNTO DE 2 PINOS PARA EIXO DA ALÇA

14785

3,50€



ROLO DE FORQUILHA

14938

41,50€



VOLANTE

14939

57,00€



UNIDADE HIDRÁULICA

14940

248,00€



ARRANCADOR DE VEÍCULOS



266

PARA BATERÍAS



267

COMPROBADORES DE BATERÍA



268

TERMÔMETROS



269

ENDOSCÓPIO COM WIFI / DETECTOR DE VAZAMENTO DE GÁS / PISTOLAS DE CALOR / FERRO DE SOLDA / MÁQUINA PARA RALLAR BORRACHAS / ESMERILADORA



270

MÁQUINA LIMPADORA DE PEÇAS / ASPIRADOR



273

LAVADORA DE ALTA PRESSÃO



276

CARRETEL ELÉCTRICO



277

VENTILADORES / ADAPTADOR DE TOMADA

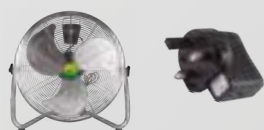

278



# FERRAMENTAS ELÉCTRICAS



SERIE364



## CABOS DE ARRANQUE

### PINÇA MACIÇA DE LATÃO

REF.	Ø CABO + TAMPA	LONGO	A	SECÇÃO			€
51238	17mm	5m	700	70mm <sup>2</sup>	5,02	2 72	129,00€
51239	15mm	7m	700	70mm <sup>2</sup>	5,98	2 72	156,00€



### PINÇA DE LATÃO

REF.	Ø CABO + TAMPA	LONGO	A	SECÇÃO			€
52069	11mm	2,5m	250	25mm <sup>2</sup>	1,62	5 160	26,50€
52070	12mm	3m	350	35mm <sup>2</sup>	2,1	5 160	36,00€
52071	13mm	3m	500	50mm <sup>2</sup>	2,34	5 90	42,50€



### PINÇA MACIÇA DE LATÃO COM PROTETOR DE SOBRECARGA

REF.	Ø CABO + TAMPA	LONGO	A	SECÇÃO			€
51363	12mm	3m	350	35mm <sup>2</sup>	2,63	5 120	103,00€
51365	12mm	3m	600	50mm <sup>2</sup>	3,12	5 90	106,00€



CE

**PINÇA MACISSA DE CÔBRE**  
**14145** 0,20 30  
 8,50€

**PINÇA MACISSA DE CÔBRE**  
**14146** 0,20 30  
 8,00€

**KIT DE 2 PINÇAS DE CROCODILO**  
**53357** 0,01 6 24  
 7,00€

**PINÇA MACISSA DE LATÃO**  
**14147** 0,35 15  
 25,00€

**PINÇA MACISSA DE LATÃO**  
**14148** 0,35 15  
 25,00€



## ARRANCADOR DE VEÍCULOS



**53687** 11,35 1 14  
 298,00€

**53688** 18,05 1 14  
 480,00€

12V DC 15A 230V 50Hz 12V 1A 6-40H

370mm 392mm 209mm

**53687** 12V 9,5kg

- Tensão: 12V.
- Bateria: 22 A'h, ácido-chumbo (1 unid.)
- Corrente de partida: 750A.
- Corrente de pico: 1500A.

**53688** 12V 24V 16,3kg

- Tensão: 12V/24V.
- Bateria: 22Ah AGM de ácido-chumbo (2 unid.)
- Corrente de partida/pico de 12V: 1500A/3000A. 24V: 750A/1500A.
- Tempo de carga da bateria: Carga total da bateria: 40 h Carga até 10-20%: 6 h



Medidor de tensão da bateria interna

Botão de verificação da tensão da bateria interna

Interruptor ligar / desligar

Toma de carga

Pinzas

Luz LED integrada: aumenta a visibilidade da área de trabalho

### PARTES SEPARADAS

REF.	DESCRIÇÃO			€
14755	Bateria 22 A'h para ref. 53687, 53688	6,50	2	133,15€
14756	Placa de circuito impresso para ref. 53687 0,05	10	10	15,15€
14757	Placa de circuito impresso para ref. 53688 0,05	10	10	15,15€
14758	Cabo de lançamento vermelho com um grampo no final para ref. 53687, 53688	0,40	10	18,00€
14759	Cabo de lançamento preto com um grampo no final para ref. 53687, 53688	0,40	10	18,00€

14755



14756



14757



14758



14759



## CARREGADORES DE BATERIA

6/12V

53927

58,00€

0,55 5 20



12/24V

53929

78,00€

0,85 5 20



COMPATÍVEL COM BATERIAS DE CHUMBO-ÁCIDO: LÍQUIDO, HÉLIO, MF E AGM

CE

## ARMAZENAMENTO DE MEMÓRIA PARA A SUBSTITUIÇÃO DAS BATERIAS

52884

69,50€

0,25 5 20 400



- Útil para manter corrente no sistema eléctrico do veículo durante troca de bateria.  
- Conexão OBDII via cabo ou isqueiro.

235mm ± 20mm

2.070mm ± 20mm



CE

## COMPROBADOR BATERIAS DIGITAL

51816

49,00€

0,3 6 48 576

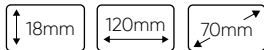

- Aplicável em baterias de 12v.  
- Medição em SAE(CCA), EN, IEC, DIN, CA.  
- Rango: 200~1200CAA (SAE).  
- Medição de voltagem: 7V~15V.  
- Display 4 + 3 Leds (verde, vermelho, amarelo).  
- 150Ah.

CE



## COMBROBADOR BATERIAS

51235

49,00€

1,35 10 150



- Para baterias de 6v e 12v.  
- Carga até 100Ah.  
- Test de Estado de carga.  
- Test de Consumo de Arranque.  
- Test de Voltajem da carga.  
- Test do estado de la Bateria.

CE



## COMPROBADOR DE BATERIAS E ALTERNADORES COM IMPRESSORA

52233

288,00€

2,32 6 72



- Aplicável a baterias de 6V e 12V.  
- Sistemas de carga encendido de 12V e 24V.  
- Alcance de operação: 40 - 2000 CCA (SAE).

- Voltímetro: 1.5V - 30V.  
- Juego de cables de 180cm.  
- Incluye:  
Pilhas 6x1.5AA.  
1 rolo de papel térmico.



PAPEL TÉRMICO 57mmx60m

51842

6,90€

0,1 6 120



COM IMPRESSORA

AGM, GEL, VRLA, SLI

CE

## HIDRÔMETRO PARA BATERIAS

53209

7,50€

0,15 10 100

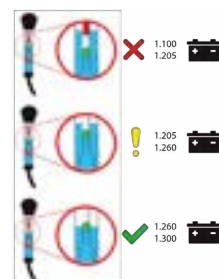



# COMPROBADOR DE BATERIAS E ALTERNADORES COM IMPRESSORA

**54040**

1,2

10

**198,00€**



- Aplicável a baterias de 12 V, AGM (tapete de vidro absorvente), GEL (gel), VRLA (ácido de chumbo regulado por válvula), SLI (com eletrólito líquido).
- Faixa de operação: 100-2.000 corrente de partida a frio CCA (SAE)
- Idiomas disponíveis do sistema: Espanhol (ES), Inglês (EN), Francês (FR), Alemão (DE), Italiano (IT), Português (PT), Romeno (RO).
- Aplicável para sistemas de partida 12/24 V.
- Aplicável a baterias de 12 V, AGM (tapete de vidro absorvente), GEL (gel), VRLA (ácido de chumbo regulado por válvula), SLI (com eletrólito líquido).
- Testador de arrancadores e alternadores.
- Uma bateria CR2032 incluída

Aplicable a baterias de  
Applicable to batteries of

**12V**

AGM GEL VRLA SLI

Aplicable a sistemas de arranque de  
Applicable to starting systems of

**12V**  
**24V**

x1 CR2032

BATTERY

Incluídas

-20°C  
50°C

100 - 2000 CCA (SAE)



COM IMPRESSORA

## PINÇA AMPERIMÉTRICA

**52382**

0,23

5

50

1.600

**18,00€**



- FUNÇÕES:  
Teste fio vivo.

**52952**

0,26

5

50

1.500

**64,80€**



- FUNÇÕES:  
Teste fio vivo.  
Teste de diodo.  
Teste de continuidade.  
Função ADP.  
Função de detecção de fase.  
Interruptor ZERO.



52382



52952

167mm  
55mm  
22mm

	52382	52952
DCB	600V	20V, 600V
ACB	600V	600V
DCA		200A
ACA	20A, 200A, 600A	200A
OHM	2KΩ, 200KΩ, 2MΩ	2000Ω

- Instrumento ideal para electricistas.
- Pode-se medir: voltagem AC, voltagem DC, Corrente AC, resistência, diodo, frequência.
- Entorno de funcionamento: 0°C a 40°C, a <80%RH.
- Entorno de armazenagem: -10°C a 40°C, a <85%RH.
- Alimentação: 2 pilhas tamanho AAA.
- Indicador de bateria baixa.
- Ecrã de 3,5" com 4 dígitos.
- Função de corrente contínua.
- Medição de voltagem AC/DC.

## MULTÍMETRO DIGITAL

**50942**

0,33

10

60

480

**24,00€**



- Autoapagado.
- Indicador de bateria.
- Baterias de 9 V.
- Sonda de temperatura.
- Temperatura de -40 °C a 1000 °C.

- Dígitos: 3 1/2.
- Medição: 2 000.
- Dados instantâneos.



CON PROTECTOR LATERAL

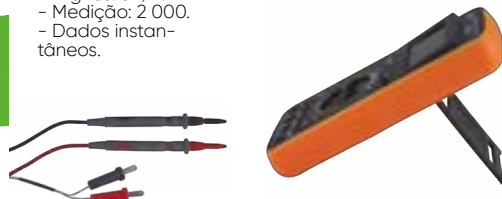

V AC	200mV, 2V, 20V, 200V, 1000V	A AC	20mA, 200mA, 20A
V DC	200mV, 2V, 20V, 200V, 750V	A DC	20mA, 200mA, 20A
Ω	200Ω, 2KΩ, 20KΩ, 200KΩ, 2MΩ, 20MΩ, 2000MΩ		
F	2nF, 20nF, 200nF, 2μF, 20μF, 200μF		



## JOGO DE CABOS E ACC. PARA REF. 50942

**52439**

3,26

1

5

40

**214,00€**



- 2 medidores de resistência variável.
- 2 luzes led de comprovação.
- 2 SRS substituição e dois dispositivos de proba.
- 2 alicates de crocodilo.
- 2 tomas de engate rápido.
- 4 sondas.
- 24 conectores redondos.
- 48 conectores lisos.





## KIT DE ACESSÓRIOS PARA MULTÍMETRO

52231

45,50€

0,41 5 40 300

- Este kit é apto para a maioria de multímetros.

- Inclui:  
2 sondas.  
2 pinças pequenas.  
2 pinças largas.  
cabos de extensão.



CE

## AUTOMOTIVE CIRCUITO TESTER

53028

4,00€

0,07 10 120 1.800

6-12-24V 1,8 x 190mm



- Adequado para verificar a polaridade.

53029

5,50€

0,08 12 240 2.400

6-12-24V 2 x 115mm

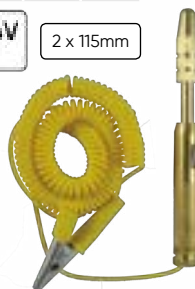

53030

10,00€

0,17 6 60 720

6-12-24V LED 3 x 142mm



## TERMÓMETRO LÁSER

### -50° A 550°C

52162

32,50€

0,17 6 72 576

- Alcance de medição: -50° a 550 °C (58 °F a 1022 °F).  
- Precisão: ± 2 °C / ± 2% .  
- Opção de retro iluminação.  
- Ponteiro laser.  
- Medição em °C / °F.  
- Emissividade: Ajustável (0,1~1,0).  
- Tempo de resposta: ≤ 0,8 s.  
- Possibilidade de bloqueio de medição.  
- Bateria DC 9V.  
- Indicador de bateria baixa.



CE

### -50° A 1.000°C

52450

117,50€

0,72 5 20 200

- Termômetro de infra-vermelho.  
- Leitura de: -50°C ~1000°C / -58°F ~ 1.832°F.  
- Tolerância +/-1,5°C.

- Funções:  
Indicação por ponteiro laser.  
Alarme de temperatura máxima ou mínima.  
Leitura em °C / °F.  
Função de memória de resultado.  
Indicador de bateria baixa.



CE

## TERMÔMETRO DIGITAL DE CONTACTO

53503

8,50€

0,05 20 100

1.5V x1

-50°C-330°C  
-58°F-572°F  
±1°C (0,2°F)  
(-20°C-80°C)



## TESTE DE FLUÍDO DE TRAVÕES

51839

24,00€

0,05 10 100 2.400

- Funciona com pilhas 1xAAA LR03.  
- Com 4 níveis de qualidade medíveis de 0% a 4%.



## ENDOSCÓPIO COM WIFI

**53724**  
39,00€

0,15 20 60 500  
720p 20FPS HD



- Endoscópio com função de transferência de imagem Wi-Fi. Capacidade de se conectar a qualquer smartphone. Suporte para trabalhar com um tablet ou computador.

- O pacote inclui:  
**Câmara endoscópica.**  
**Transmissor Wi-Fi.**  
**Capa de gancho.**  
**Capa de imã.**  
**Capa de espelho lateral.**



2560x1920  
1280x720  
640x480

5MP

- Resolução: 2560x1920 / 1280x720 (720p 16:9) / 640x480 (480p 4:3).  
- 20fps.  
- 5 megapixels.  
- Ângulo de visão: 70 graus.  
- Diâmetro: 5,5mm.  
- Distância focal: 4-6cm.  
- Resistente à água IP67 (até 1 metro).  
- Bateria de lítio 2.600mAh.



CABO SEMI-RÍGIDO DE 1M

Ø 5,5MM



FUNCIONA COM JBM APP:



App Store  
Google Play



ASSISTA AO TUTORIAL EM VÍDEO  
YouTube

## ENDOSCÓPIO INDUSTRIAL CABLE 1m

**52436**  
1.170,00€

2,41 5 40



- Alimentação: DC5.  
- Monitorar 3,5TFT 320x240px.  
- Interface: MINI USB 1.1/AV.  
- Bateria recarregável Li-Polymer 3.7V.  
- Adaptador: 100-240V.  
- Saída AC 5VDC.  
- Vídeo em NTSC&PAL.  
- Armazenamento: CARD SD (até 32Gb).  
- Compressão: JPG.  
- Gravação: MPEG4 (640x480).  
- Temperatura de trabalho: -20°C - 60°C.  
- Temperatura de armazenamento: 0°C - 40°C.  
- Diam. cablu: 5 mm.  
- Funções: a saída de vídeo, 6 idiomas, auto-off, fotos, vídeos, data/hora.



VISOR A CORES

1M

PONTA PARA ENDOSCÓPIO

**11992** 0,01 20  
65,00€

CABLE 3m

**11219** 0,32 1  
659,00€

CABLE 1m

**11329** 0,22 1  
564,00€

## DETECTOR DE VAZAMENTO DE GÁS

**53484**  
615,00€

5 4 28

- ÓLEO NÃO INCLUIDO.

275mm 220mm 235mm

12V 6 L/m 15PSI



ÓLEO 500ML POR REF. 53484  
**14081** 0,5 32 640  
12,55€

TUBO DE REPOSIÇÃO PARA 53484  
**14109** 20  
29,00€

BOMBA INFLADORA PARA 53484  
**14110** 1 70  
110,00€

ASSISTA AO TUTORIAL EM VÍDEO  
YouTube



Inclui:



## PISTOLA DE COLA TERMOFUSÍVEL

**51831**  
21,00€

0,35 12 36 252

- Voltagem: 100~ 230 V.  
- Temperatura: 190~230 °C.  
- Consumo: 60~150 W.  
- Diâm. de boca: 2,0~2,3 mm.  
- Alcance: de 8 a 16g de producto / minuto.



ADHESIVO TERMOFUSÍVEL

**51859** 0,12 8 32 1.520  
3,80€

- Ø 8mm.  
- Pegam rapidamente todo tipo de materiais flexíveis.  
- Tempo de secado 20".

CE

## FERRO DE SOLDA

40W

100W

53977

0,30 12 48 576



14,50€



- Tensão 220-240 V
- 40 W
- Frequência: 50Hz
- Comprimento: 240mm
- Cabo: 1,3 m
- Temperatura máxima de trabalho: 450°+/-10%



53111

0,28 5 25 500



LATA DE SOLDA

17,00€



- Voltagem: 220-240V.
- Temp.: 420°C + / - 10%.
- Largo: 250mm.
- Cable: 1,5m.



## MÁQUINA DE SOLDA INVERTER MMA

53981

3,35 1 90

100A DC

119,00€



- Pode ser usado para soldar peças de aço e ferro com todos os tipos de eletrodos ácidos e alcalinos.
- Ferramenta compacta, leve e economizadora de energia.
- Alta qualidade de ignição de arco e potência de arco, arco estável e poucos respingos.
- Soldagem de alta qualidade, alta profundidade de penetração.
- Proteção automática contra sobretensão, sobre-corrente e superaquecimento.
- A tecnologia IGBT melhora significativamente a confiabilidade do dispositivo.
- Ela fornece equalização automática quando a tensão de entrada flutua.



- ✓ INVERSOR COM TECNOLOGIA IGBT
- ✓ SOLDAGEM MANUAL DC SOLDAGEM A ARCO
- ✓ PROTEÇÃO CONTRA QUEIMAD+H5URA
- ✓ POTÊNCIA DO ARCO
- ✓ IGNIÇÃO DE ARCO QUENTE

- Completo:
- Porta-eletrodo com cabo de 2m.
- Pinça de aterramento com cabo de 1,5m.
- Escova de martelo.
- Máscara facial manual.



REPOSIÇÃO PARA REF. 51837

REF.	DESCRIÇÃO	€
15237	Porta-eletrodo com cabo de 2m	12,00€
15238	Escova de martelo de soldador	5,00€
15239	Protetor facial manual	5,50€
15240	Pinça de aterramento com cabo de 1,5m	9,50€
15241	Painel de junção	65,00€
15242	Conexão de acoplamento rápido (negativa/positiva)	2,50€
15243	Ventilador	4,00€
15244	Interruptor de alimentação	2,00€

53982

6,10 1 33

160A DC

214,50€



- Muito utilizado para soldagem de decoração de interiores e trabalhos em altura.
- Compacidade, estabilidade e confiabilidade.
- Fácil acesso ao arco, poucos respingos e formação estável.
- A tecnologia IGBT melhora significativamente a confiabilidade do dispositivo.
- Eletrodos básicos e rutilicos podem ser usados.
- Alta tensão sem carga e potência do arco.
- Proteção automática contra sobretensão, sobre-corrente e superaquecimento.
- Corrente de soldagem estável com tensão de entrada flutuante e capacidade de equalização automática com tensão de entrada flutuante.



- ✓ INVERSOR COM TECNOLOGIA IGBT
- ✓ SOLDAGEM MANUAL DC SOLDAGEM A ARCO
- ✓ PROTEÇÃO CONTRA QUEIMAD+H5URA
- ✓ POTÊNCIA DO ARCO
- ✓ IGNIÇÃO DE ARCO QUENTE

- Completo:
- Porta-eletrodo com cabo de 2m.
- Pinça de aterramento com cabo de 1,5m.
- Escova de martelo.
- Máscara facial manual.



REPOSIÇÃO PARA REF. 51837

REF.	DESCRIÇÃO	€
15238	Escova de martelo de soldador	5,00€
15239	Protetor facial manual	5,50€
15245	Pinça de aterramento com cabo de 1,5m	7,50€
15246	Painel de junção	108,00€
15247	Conexão de acoplamento rápido (negativa)	2,50€
15248	Conexão de acoplamento rápido (positiva)	2,50€
15249	Ventilador	5,00€
15250	Interruptor de alimentação	4,50€
15251	Porta-eletrodo com cabo de 2m	15,00€



## PISTOLA DE CALOR 2000W

53145

38,50€

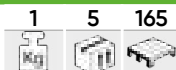

- 220V-240V.
- 50Hz-60Hz.
- 2000W.



- Temperatura de saída: 50-600°C.
- Fluxo de ar: 220-480L/min.
- 2 opções de temperatura: 300 i 600°C.

53162

56,00€

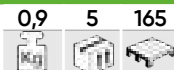

- 220V-240V.
- 50Hz-60Hz.
- 2000W.



- Temperatura de saída: 100-600°C.
- Fluxo de ar: 280-480L/min.



DIGI-TAIS

## MÁQUINA PARA RALLAR BORRACHAS

52643

478,35€

POTÊNCIA MÁXIMA: 350W

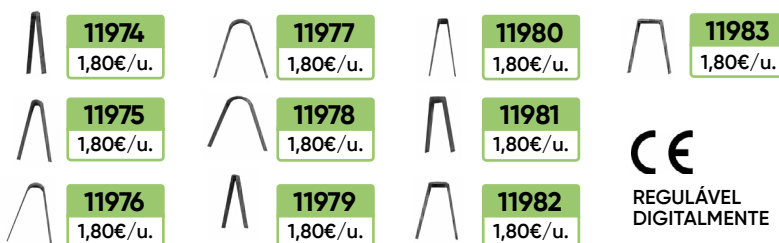

REGULÁVEL DIGITALMENTE

### REPUESTOS

REF.	11974	11975	11976	11977	11978
CUTTER TIPO	R1	R2	R3	R4	R5
LÂMINA REDONDA	mm	mm	mm	mm	mm
	A	3	5	6	8
	B	7	7	10	12
	C	5	8	15	16
	D	21	21	23	25

REF.	11979	11980	11981	11982	11983
CUTTER TIPO	W1	W2	W3	W4	W5
LÂMINA QUADRADO	mm	mm	mm	mm	mm
	A	3	5	7	9
	B	7	7	10	12
	C	5	6	10	13
	D	21	21	22	24

## ESMERILADORA DUPLA ELÉCTRICA

450W

600W

250W

250W

53656

187,50€



53657

231,50€

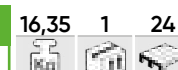

53658

98,50€



53659

145,50€



53656 53657



53658



53659

Botão de fixação do suporte

Rebolo

Tampa protetora

Rebolo

Tanque de água

Tampa protetora  
Rebolo sem resfriamento

## BASE METÁLICA PARA MOEDOR DE BANCADA

**53660**

**136,50€**

8,60 1 28

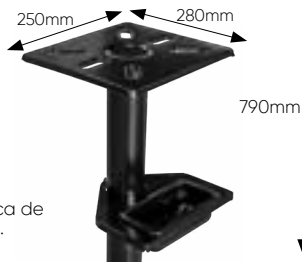

- Altura: 790mm.
- Dimensões da placa de fixação: 250x280mm.

## ESMERILADORA DUPLA ELÉCTRICA 150mm

**52195**

**170,00€**

7,08

1

48



- Potência nominal entrada 250w.
- Tensão nominal 230v / 50hz.
- Velocidade sem carga 2950rpm.
- Diâmetro da roda 150 x 20 x 12,7mm



## TANQUE DE LIMPEZA DE PEÇAS

**50632**

**327,00€**

24,3 1 6



**100L**

MEDIDAS TOTALES MÁQUINA

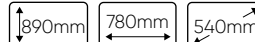

MEDIDAS INTERIORES DEPÓSITO

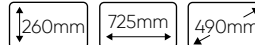

**PINCEL REPUESTO**  
**11100** 0,3 100  
**24,25€**

**52980**

**745,00€**

45 1 4



**150L**

MEDIDAS TOTALES MÁQUINA



MEDIDAS INTERIORES DEPÓSITO

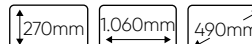

- Caudal: 25L.
- Funciona com soluções de limpeza de motor solúveis em água.

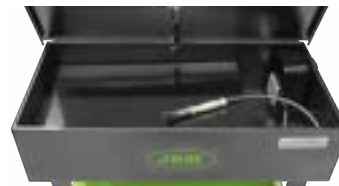

**REPOSIÇÃO DE BOMBA**  
**11101** 0,3 100  
**153,50€**

**FILTRO REPOSIÇÃO**  
**11102** 0,3 100  
**6,60€**

## LIMPADOR DE PEÇAS PORTÁTIL

**53220**

**368,00€**

79 1 8



- FORMATO PORTÁTIL.
- Permite o fecho estanque para evitar perdas durante o transporte.
- Usar com solvente de base aquosa.

- Tomada de acendido lateral.
- Filtro de limpeza de líquido incluído.
- Gancho de ferramentas e de mangueira incluído.
- Compartimento de armazenamento.
- Separação de áreas de trabalho, área de limpeza e área de secagem, aceita o trabalho com varias peças a tudo de uma vez.

- Capacidade máxima: 275 l.
- Capacidade de bombeamento: 1.000 L/h.
- Capacidade de trabalho: 20L.
- Conexão a 220V.
- Mangueira de 1,10m de longo.



## ASPIRADOR

**51837**

195,00€

8,25 1 9



SECO DE 30L

30L

**51838**

734,00€

28 1 2



SECO + HÚMEDO 80L

80L



	51837	51838
Volume (L)	30	80
Volume de sucção por segundo (L/s)	26	50
Potência	1x1.200W	3x1.000W
Tensão	230V	230V
Frequência	50Hz	50Hz
Sucção	> 17Kpa	> 20Kpa
Ø mangueira	32mm	48mm
Comprimento da mangueira	1,5m	2m
Comprimento do cabo	4,5m	4,5m
Vedação	IPx4	IPx4

INCLUI



REPOSIÇÃO PARA REF. 51837

REF.	DESCRIÇÃO	€
10720	Mangueira plástico 1,5m	24,50€
11095	Mangueira plástico 3m	31,00€
10721	Tubo de metal extensível	19,00€
10761	Filtro	16,00€

INCLUI



REPOSIÇÃO PARA REF. 51838

REF.	DESCRIÇÃO	€
10722	Mangueira plástico 1,5m	24,50€
11098	Mangueira plástico 6m	56,50€
10723	Ponta superior	29,50€
10724	Ponta inferior	29,50€
10762	Filtro	23,50€

## PULVERIZADOR INDUSTRIAL

**53820**

388,00€

12,55 1 6



- ALTA EFICIÊNCIA:  
x7-10 vezes maior que o pulverizador manual

- BOA DIFUSÃO:  
economiza água e pesticidas

- DESINFECTA UMA AMPLA COBERTURA  
através de finas partículas de fumaça

Capacidade do tanque	15L
Distância de pulverização	8-10m
Tamanho de partícula líquida	<50 microns (µm)
Capacidade do tanque de combustível	2L
Consumo de gás	3,2L/h





# CORTADOR DE GRAMA ROBÔ

52598

1.080,00€

7,5

1

- Robô cortador de grama autônomo.  
- Sem fio e fácil de guardar.

5200 mAh  
Capacidade de la batería  
Battery capacity

1400m³  
Superfície de corte  
Mowing area

115,44W  
Consumo de energía  
Power consumption

AC 100-240V  
50-60Hz  
Frecuencia de entrada  
Input voltage

DC 15-28,5V  
Tensión de salida  
Output voltage

ALTURA DE CORTE:  
2,5 - 5,5CM

2,5H

2H

70 dB

IP X4

7,5kg

22m/min

50-35,5-24 cm

LARGURA DE CORTE:  
18CM



ESTAÇÃO PARA CARREGAR

VELOCIDADE DE ROTAÇÃO DA LÂMINA:  
3500RPM



REF.	DESCRIÇÃO	QTD	€
15424	Fio de conexão 150m	15	105,00€
15425	Suportes para fio de conexão 150 pçs	15	50,00€
15426	Lâmina de corte e parafusos	100	10,00€
15427	Pregos da estação de instalação	50	9,00€
15428	Bateria 22,2 v, 2 600 mah	10	238,00€
15429	Fio de extensão 5 m	10	23,50€
15430	Adaptador	10	83,00€
15431	Estação de carregamento	5	241,00€
15432	Tomada do fio de conexão	10	18,50€
15433	Garagem	1	169,00€
15434	Roda traseira e motor	5	147,00€
15435	Placa de corte e placa de proteção	5	24,50€
15436	Motor de corte	10	97,00€
15437	Mãe placa (com função wifi)	5	305,50€
15438	Sensor do fio de conexão	10	31,00€
15439	Rodas dianteiras	10	52,00€



CONEXÃO DE APP



# LAVADORA DE ALTA PRESSÃO

Esta lavadora de alta pressão com motor de 1400 W / 2400 W é ideal para limpar bicicletas, carros, equipamentos externos, pátios, terraços, estufas e muito mais.

**53947**

144,90€

5,80

1

31

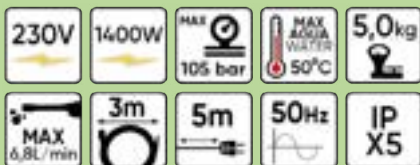

## MOTOR



- Pressão nominal: 70 bar
- Fluxo: 5,5 L/min
- Máx. pressão de entrada: 4 bar
- Tamanho: 28x25,5x44 cm
- Tipo de motor elétrico: escova

**15398**

74,50€

- Incluído:
- 1 spray
- 1 mangueira de alta pressão 3 m
- 1 cabo de alimentação 5 m



**53948**

323,50€

12,10

1

10

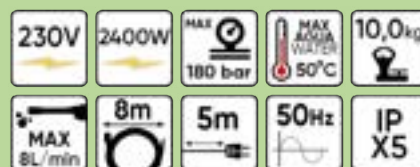

## MOTOR



- Pressão nominal: 120 bar
- Taxa de fluxo: 5,5 l/min
- Máx. pressão de entrada: 4 bar
- Tamanho: 44x34,5x50,5cm
- Tipo de motor elétrico: escova

**15399**

116,50€

- Incluído:
- 1 spray
- 1 mangueira de alta pressão 8 m
- 1 cabo de alimentação 5 m
- 1 bocal turbo
- 1 conexão transparente
- 1 gerador de espuma 750ml
- 1 limpador de pátio
- 1 escova de pneu
- 1 escova fixa



## PULVERIZADOR

**15388** - 20  
33,00€

**MANGUEIRA DE PVC 5M**  
**15389** - 20  
18,50€

**LIMPADOR DE SUPERFÍCIE 8 POLEGADAS**  
**15390** - 12  
42,50€

**TRAVA DE PRODUTO FIXO**  
**15391** - 50  
13,50€

**ESCOVA DO ARO**  
**15392** - 50  
17,50€

## BOCAL TURBO

**15393** - 100  
12,50€

**PULVERIZADOR DE ESPUMA**  
**15394** - 100  
26,00€

**CONECTOR DE MANGUEIRA**  
**15395** - 50  
3,50€



## CARRETEL ELÉCTRICO - 21m

53585

168,00€



53586

158,00€



COM SU-  
PORTE DE  
PAREDE

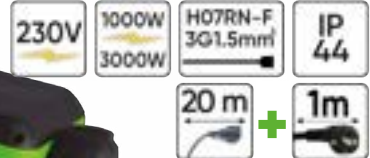

PROTEÇÃO DIFEREN-  
CIAL DE SOBRECARGA



SUPORTE DE PAREDE

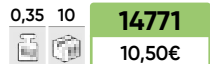

COM  
REPARTIDOR



## CARRETEL ELÉCTRICO - 12M

53584

108,00€



53526

118,00€



COM SU-  
PORTE DE  
PAREDE



SUPORTE DE PAREDE



COM  
REPARTIDOR



PROTEÇÃO DIFERENCIAL  
DE SOBRECARGA



BLOCO  
DE CABO



## EXTENSÃO MANUAL DE CABO ELÉCTRICO

51033

98,00€



- Protecção de sobrecarga.  
- Protecção infantil.



## EXTENSÃO DE CABO DE CORRENTE

53166

10,50€



3m

53167

12,50€



5m

53168

19,00€



10m





## VENTILADOR DE VEÍCULO - 12 V

53543

13,80€

197

1

2



## VENTILADOR DUPLO DE CARRO

53600

13,80€

0,55

5

20

160



53601

18,00€

0,65

5

20

120

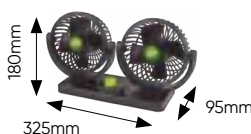

## COMPRESSOR DE AR

53150

22,50€

0,55

10

40

480



120mm

165mm

55mm

- Aplicar aos carros:  
Carro de família, SUV,  
etc.

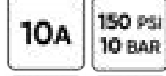

## VENTILADOR



DE PÉ

53189

99,00€

7,1

1

12



1.325mm

480mm

∅ 565mm

DE CHÃO

53190

98,00€

6,1

1

16



1575mm

230mm

∅ 620mm



## ADAPTADOR DE TOMADA

USB

13839

8,50€

0,08

200



USB



ESTAÇÃO DE ENERGIA



280

PAINEL SOLAR



280

CARRO ELÉTRICO



281

DISTÂNCIA DE SEGURANÇA

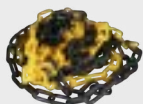

282

FERRAMENTAS ALTA VOLTAJEM



282



# ENERGIA RENOVÁVEIS E MOBILIDADE DE AMANHÃ





## ESTAÇÃO DE ENERGIA 1 920 Wh

53970

34,70

1

13

3.790,00€



A estação de energia portátil é um poderoso gerador elétrico portátil que pode ser carregado com energia solar e, na ausência de luz solar, também pode ser carregado com qualquer fonte de energia.



Saída nominal de CA Rated AC output <b>3000W</b>	Carga rápida Fast Charging <b>54V/10A</b> 3-4h	Carga solar Solar Charging <b>54V/7.5A</b> 4-5h	<b>220VAC</b> ± 10%
Pico de saída de CA Peak AC output <b>6000W</b>	Tipo de bateria Battery type <b>LiFePO4</b>	Temperatura de operação Operating temperature -10°C a +60°C	Temperatura de carga Charging temperature 0°C a +5°C
Capacidade de carga Capacity <b>+2000</b>	Frequência Frequency <b>50Hz</b>	Tipo de LED LED type <b>2W*2 LED</b>	
USB-QC 5V/9V/ 12V/3A	DCx2 12V/10A	USB-Type-C 5V/3A/9V/ 3A/12V/1.5A	USB 5V 2.4A*2
CC-CA MPPT	Dimensões 383mm x 427mm x 244mm	Tipo de saída Output type 12V 10A	Tipo de saída Output type Universal



INCLUI:



Carregador de bateria



Carregador solar por placa solar



Cabo de ligação por carregador de parede

GENERADOR DE ENERGIA

ENERGIA EM QUALQUER PARTE

VASTA GAMA DE APLICAÇÕES



<b>3000W</b> +0,75h	<b>2000W</b> +1h	<b>1500W</b> +1h	<b>1000W</b> +1,5h	<b>120W</b> +12h
<b>200W</b> +7,5h	<b>70W</b> +22h	<b>30WH</b> +50 vezes	<b>10WH</b> +150 vezes	<b>100W</b> +15h
<b>20W</b> +75h	<b>2200W</b> +1h	<b>500W</b> +3h	<b>500W</b> +3h	<b>2000W</b> +1h

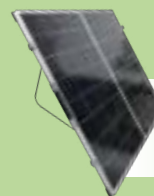

COMPATÍVEL COM 53971

## PAINEL SOLAR 200 W

53971

13,45

2

12



350,00€



ALTA POTÊNCIA

Aberto:

884mm x 1320mm x 54mm

Fechado:

884mm x 659mm x 54mm

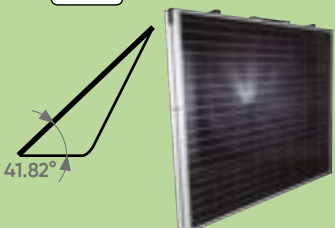

### CONJUNTO DE 2 CONECTORES

MC4 1000V 30A

15448



5,50€



FÁCIL TRANSPORTE

FÁCIL DE INSTALAR

## PAINEL SOLAR

54062

28,5

31

535W

585,00€



2256mm x 1133mm x 35mm

### CARACTERÍSTICAS MECÂNICAS

Tipo de item: Monocristalino (tipo P), 182x91mm  
 Número de elementos: 144 (6x24)  
 Número de pneus por fotocélula: 10  
 Vidro: alta transparência, 3,2 mm, revestimento anti-reflexo

Cabo de saída (plug incluído):  
 diâmetro: 4,0 mm2  
 Comprimento: 300/400 mm (personalizável).  
 Caixa de junção: IP68, 3 diodos shunt.  
 Conector: compatível com MC4



### ESPECIFICAÇÕES ELÉTRICAS

(CONDIÇÕES DE TESTE PADRÃO)  
 Potência máxima: 535W  
 Fotovoltagem: 49,6 V  
 Voltagem máxima: 41,8V  
 Corrente de curto-circuito: 13,60 A  
 Corrente máxima: 12,80 A  
 Eficiência do módulo: 20,93%.

### DADOS ELÉTRICOS

(TEMPERATURA DE OPERAÇÃO NORMAL DOS ELEMENTOS)  
 Potência máxima: 398W  
 Fotovoltagem: 46,5 V  
 Voltagem máxima: 39,2V  
 Corrente de curto-circuito: 10,99 A  
 Corrente máxima: 10,15 A

### CARACTERÍSTICAS DE DESEMPENHO

Máx. tensão do sistema: 1000 V/1500 V CC  
 Temperatura de trabalho: -40 °C a +85 °C  
 Máx. corrente do fusíveis: 25 A  
 Carga de neve, lado frontal: 5 400 Pa

Carga do vento, lado traseiro: 2 400 Pa  
 Temperatura nominal de operação do quadro de junção: 45 ± 2 °C  
 Nível de aplicação: Classe A



JBM SOLAR ENERGY

Contacte-nos em:  
[solar@jbmcamp.com](mailto:solar@jbmcamp.com)

para cotações, relatórios, preços e informações técnicas



# CARRO ELÉTRICO



Híbrido e elétrico

## CABO DE CARREGAMENTO

<b>54053</b> 248,00€	2,5 5	<b>16A</b>	<b>3.6 kW</b>	<b>Tipo 1-2</b>	Monofásico Single-Phase
<b>54054</b> 336,00€	3 5	<b>32A</b>	<b>7.5 kW</b>	<b>Tipo 1-2</b>	Monofásico Single-Phase
<b>54055</b> 268,00€	2,5 5	<b>16A</b>	<b>3.6 kW</b>	<b>Tipo 2-2</b>	Monofásico Single-Phase
<b>54056</b> 280,00€	3 5	<b>16A</b>	<b>11 kW</b>	<b>Tipo 2-2</b>	Trifásico Three-Phase
<b>54057</b> 298,00€	3 5	<b>32A</b>	<b>7.5 kW</b>	<b>Tipo 2-2</b>	Monofásico Single-Phase
<b>54058</b> 347,00€	3 5	<b>32A</b>	<b>22 kW</b>	<b>Tipo 2-2</b>	Trifásico Three-Phase

## CARREGADOR DE REDE

<b>52600</b> 884,00€	6 4	<b>16A</b>	<b>3.6 kW</b>	<b>Tipo 2</b>	Monofásico Single-Phase
<b>52902</b> 904,00€	6 4	<b>32A</b>	<b>7.5 kW</b>	<b>Tipo 2</b>	Monofásico Single-Phase
<b>52903</b> 920,00€	7 4	<b>16A</b>	<b>11 kW</b>	<b>Tipo 2</b>	Trifásico Three-Phase
<b>54052</b> 960,00€	7 4	<b>32A</b>	<b>22 kW</b>	<b>Tipo 2</b>	Trifásico Three-Phase



SAE J1772



IP 66 5m -25° +55° Tipo 1-2



## ESTAÇÃO DE CARREGAMENTO

<b>54059</b> 580,00€	3 5	<b>16A</b>	<b>3.68 kW</b>	<b>Tipo 2</b>	IP 66 6m -25° +55°
-------------------------	-----	------------	----------------	---------------	--------------------



IEC 62196-2

IP 66 5m -25° +55° Tipo 2-2

## CARTÃO RFID

<b>15460</b> 3,00€	0,52 500
-----------------------	----------



## POSTE DE PLÁSTICO PARA CADEIA ALTA TENSÃO

**53940**

0,55 6 96

- Material: PVC.

13,20€



ESPECIAL  
SINALIZAÇÃO DE ALTA  
TENSÃO



BASE INFLÁVEL

850mm



CADEIA NÃO INCLUÍDA

✓ Para uma vedação simples, rápida e móvel de áreas interiores e exteriores com limitações.

✓ Suas cores contrastantes tornam a corrente altamente visível para restringir áreas de alta tensão.



## ELO DE FECHAR

**53942**

0,01 50 5.000 75.000

0,50€



## CADEIA DE PVC

**53941**

0,30 40 600

5,75€



- Comprimento: 5m  
- Link: 6mm  
- Cor: Vermelho / Branco

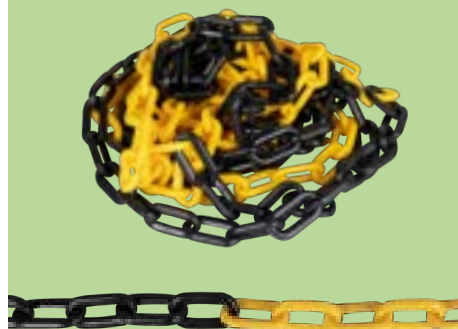

## FITA DE SINAL 200M

**53987**

0,59 40 560

8,30€



200M X 10cm



## PINÇA AMPERIMÉTRICA

**52382**

0,23 5 50 1.600

18,00€



**52952**

0,26 5 50 1.500

64,80€



	52382	52952
DCB	600V	20V, 600V
ACB	600V	600V
DCA		200A
ACA	20A, 200A, 600A	200A
OHM	2KΩ, 200KΩ, 2MΩ	2000Ω

55mm

167mm

22mm

## MULTÍMETRO DIGITAL

**50942**

0,33 10 60 480

24,00€



CE

- Dígitos: 3 1/2.  
- Medição: 2 000.  
- Dados instantâneos.



- Autoapagado.  
- Indicador de bateria.  
- Baterias de 9 V.  
- Sonda de temperatura.  
- Temperatura de -40 °C a 1000 °C.

<b>V</b> - AC	200mV, 2V, 20V, 200V, 1000V	<b>A</b> - AC	20mA, 200mA, 20A
<b>V</b> - DC	200mV, 2V, 20V, 200V, 750V	<b>A</b> - DC	20mA, 200mA, 20A
<b>Ω</b>	200Ω, 2KΩ, 20KΩ, 200KΩ, 2MΩ, 20MΩ, 2000MΩ		
<b>F</b>	2nF, 20nF, 200nF, 2μF, 20μF, 200μF		

## FERRAMENTAS ALTA VOLTAJEM

VEJA A PAG. 33





ACESSÓRIOS DE OFICINA



284

ORGANIZADORES



287

KIT DE EMERGÊNCIA



289

SENSORES DE ESTACIONAMENTO



295

AUTOMOÇÃO



296

ESCOVAS DE LIMPEZA



297

CONTADORES



298

VÁLVULAS TPMS



299

PARA PNEUS



302

TUBOS FLEXÍVEL



304



# ACESSÓRIOS





## CARRETEL DE MANGUEIRA DE ÁGUA

53872

134,00€

7,50

1

21



- Comprimento: 15 + 1,5 m
- Conexão 3/4"
- Diâmetro da mangueira: 1/2"
- Diâmetro interno: 11,5 mm
- Diâmetro externo: 15,8 mm
- Pressão de trabalho 120 psi/8 bar
- Enrolamento de mangueira automático
- Material da mangueira: PVC



CONECTOR DE MANGUEIRA 1/2"

15153

2,50€

0,1

50



CONECTOR

15154

7,50€

0,1

50



## CARRETEL DE MANGUEIRA DE AR

VEJA A PAG. 146

53582

178,50€

10,85

1

14

22M



53583

169,50€

53532

124,00€

6,2

2

30

13M



53581

107,50€

53881

69,00€

6,2

2

30

11,5M



53882

69,00€

## CARRETEL ELÉCTRICO

VEJA A PAG. 277

53585

168,00€

8,35

2

34

21M



53586

158,00€

53526

118,00€

5,15

4

48

12M



53584

108,00€

## CARRETEL DE MANGUEIRA PARA ÓLEO

50797

490,00€

26,60

1

14

160 BAR

À base de óleo / bobina  
Comprimento da mangueira:  
15 + 1 m  
Máx. pressão de trabalho:  
2.450 psi  
Entrada de ar: 1/2" BSPT  
(rosca cônica padrão  
britânico)  
Saída de ar: 1/2", rosca cônica  
padrão britânico  
Material: aço



ACESSÓRIOS DE OFICINA

## ESCADA TELESCÓPICA

**51982**

**99,00€**

5,51 1 40



↑ 2.000mm  
↓ 730mm

6 degraus

**51983**

**149,00€**

9,41 1 23



↑ 3.200mm  
↓ 930mm

9 degraus

**51984**

**178,00€**

10,78 1 21



↑ 3.800mm  
↓ 1.020mm

12 degraus

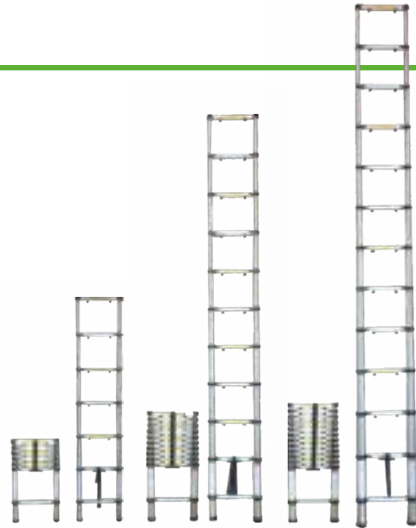

51982

51983

51984



470mm

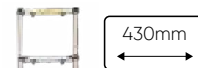

430mm



270mm

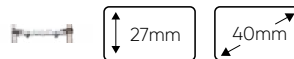

27mm

40mm



## ESCADA TELESCÓPICA EM "V" DOBRÁVEL

**52149**

**198,00€**

13,97 1 13



- Escada dobrável e leve.
- Sistema de dobrado mediante bloqueio.
- Fabricada em alumínio e plástico.

- Altura fechada: 835mm.
- Altura aberta: 3800mm.
- Altuar dobrada: 1900mm.

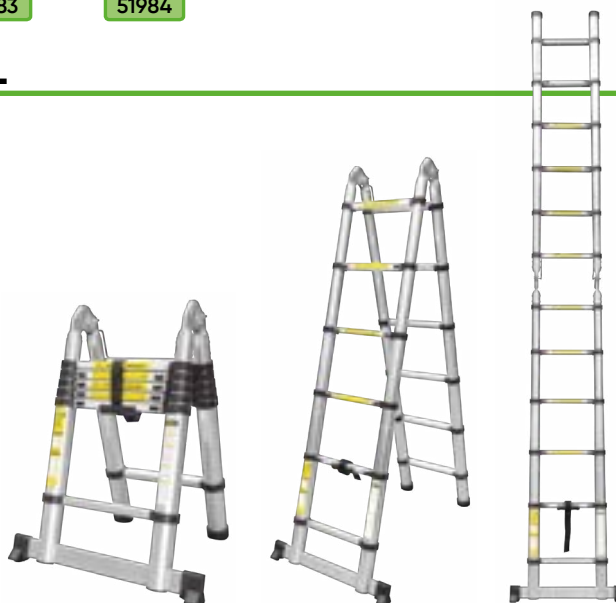
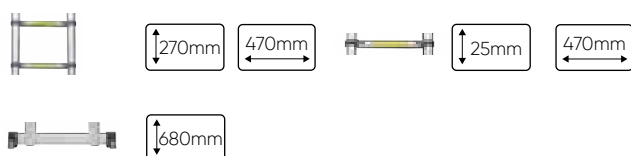

CUMPRE COM: EN 131

## ESCADOTE DE ALUMÍNIO

**50517**

**99,00€**

4 1 18



- 4 DEGRAUS
- Altura total: 1,30m.
- Altura máx. trabalho: 0,79m.

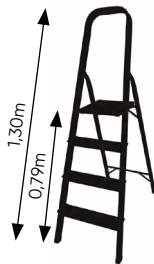

**50518**

**128,00€**

4,7 1



- 6 DEGRAUS
- Altura total: 1,91m.
- Altura máx. trabalho: 1,31m.

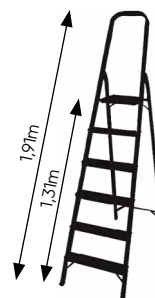

## JOGO DE 2 PLATAFORMAS DE ALUMÍNIO

**50656**

**250,00€**

10,45 1 12



PLATAFORMAS DE ALUMÍNIO

**15552**

**181,00€**



**11897**

**155,00€**

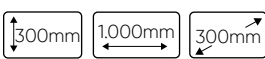

CUMPRE COM: EN 131

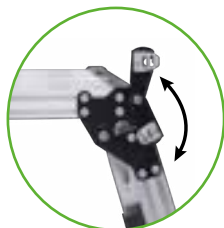

IVA não incluído

JBM

www.jbmcamp.com

285

## PLATAFORMA DE ALUMÍNIO TELESCÓPICA

52230

16,75

1

14

150kg

295,00€



CUMPRE COM: EN 131

- Largura da plataforma: 300mm.
- Altura ajustável da plataforma: 520-900mm.
- Largura da barra: 40mm.
- Distância entre as barras: 250mm.

- Posições: 42 (14 de horizontais x 3 de verticais).
- Altura 1: 520mm.
- Altura 2: 700mm.
- Altura 3: 900mm.

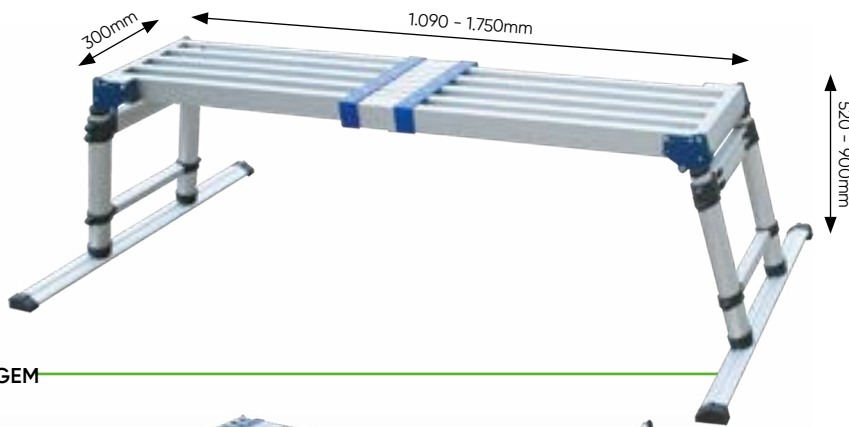

SUPER LEVE



DOBRAGEM



FÁCIL MONTAGEM

PÉ DE RECAMBIO PARA PLATAFORMA REF. 52230

10966

0,06

1

13,50€



PROTECTOR CANTOS PLATAFORMA REF. 52230

10965

0,01

1

6,00€



TIPO DE ESCADA PARA PLATAFORMA REF. 52230

10964

0,01

1

9,00€



## PLATAFORMA DE ALUMÍNIO GRANDE

50913

6,5

1

20

100kg

169,00€



800mm 1400mm 300mm

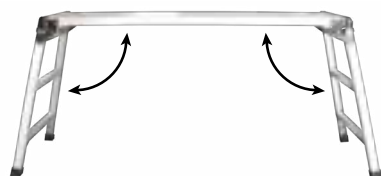

CUMPRE COM: EN 131



## CARRINHO DE MÃO

52201

6,18

1

30

66,00€



90kg

ABERTO

1.060mm 380mm 400mm

FEXADO

700mm 400mm 200mm



DOBRÁVEL E EXTENSÍVEL



## CARRINHO DE MÃO 2 RODAS BASICO DE AÇO

52202

9,35

1

10

200kg

80,00€



110mm 450mm 500mm



RODA DE PLÁSTICO 3.00-4 (260x85) PARA REF. 52202

12055

1,11

10

160

20,00€





## CARRINHO PLATAFORMA DE AÇO

52200

88,00€



150Kg

ABERTO

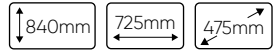

FEXADO

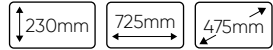

DOBRAGEM



2 RODAS ROTATIVAS

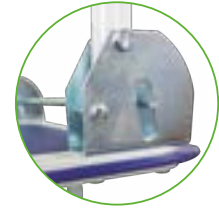

## CAIXA COM COMPARTIMENTOS

50958

38,00€



## ORGANIZADOR DE 5 COMPARTIMENTOS

51051

28,00€

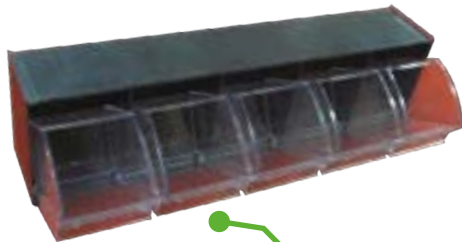
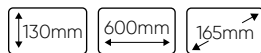
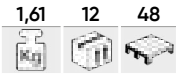

CAIXAS INSEPARÁVEIS

## ESTANTERIA COM 47 COMPARTIMENTOS

51050

195,00€

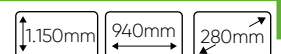

COMPARTIMENTOS GRANDES  
Total: 15  
Medidas: 24x14,5x13 cm  
Medidas da estanteria: 84x14x24 cm  
Total estantes: 3

COMPARTIMENTOS PEQUENOS  
Total: 32  
Medidas: 16x10x7,5 cm  
Medidas da estanteria: 84x16x8 cm  
Total estantes: 4

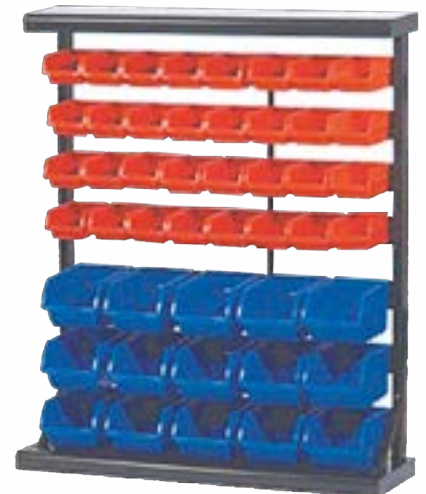

## KIT 8 CAIXAS DE ENCAIXE COM GUÍA

50960

21,50€

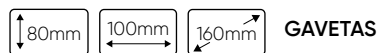

GAVETAS



GUIA



ORGANIZADORES

## CAIXA 18+1 COMPARTIMENTOS

**50959**  
12,00€

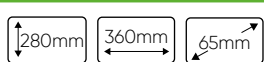

- 18 compartimentos de 6x7 cm.
- 1 compartimento de 35x7 cm.
- Abatível 19 a 4 separações.



## CAIXA 24+2 COMPARTIMENTOS

**50957**  
22,00€

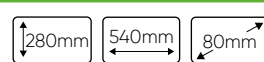

- 24 compartimentos de 8x5,5 cm.
- 2 compartimentos de 15x7,5 cm.
- Abatível de 26 a 5 separações.

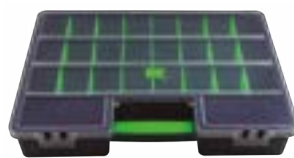

## SACO MINI PARA KIT DE EMERGÊNCIA 550 x 150mm

**REF.** 0,05 100 3.200  
2,50€

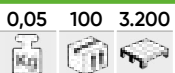

53621 53623  
53622 53624



VELCRO

## BOLSA COM 1 COMPARTIMENTO ROJO 565 x 100 x 130mm

**51681**  
4,50€

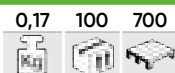

- Em tela "red" e com feixo de velcro.



VELCRO



## SACO VERDE DE NYLON ESPECIAL 470 x 65 x 140mm

**10945**  
2,30€



VELCRO

## BOLSA COM 6 COMPARTIMENTOS E DIVISÃO 570 x 100 x 130mm

**51680**  
2,40€



VELCRO

- Em tela "red" e com feixo de velcro.
- Divisão central com 6 compartimentos.



## SACO CON RIBETE 550 x 90 x 130mm

**REF.** 0,12 100 1.100  
3,50€



51692 51694  
51693 51696



VELCRO

## SACO PRETO PARA KIT DE EMERGÊNCIA EN PVC 570 x 110 x 65mm

**51691**  
2,40€



VELCRO

## LUVAS DE NITRILO, VINIL, COURO, ALGODÃO ...

VEJA A PAG. 306



# KIT EMERGÊNCIA

VER O PREÇO PARA AS QUANTIDADES  
DESENHO PERSONALIZÁVEL, PEDE COTAÇÃO  
SERIGRAFIA E FOTOLITO NÃO INCLUI



## KIT DE EMERGÊNCIA EM CAIXA DE PLÁSTICO

**53540**  
23,00€



2 TRIÂNGULOS DE SINALIZAÇÃO



Configurável a partir de **50 unidades.**

\* Duplo triângulo, obrigatório só em Espanha.

## KIT EMERGÊNCIA SACO COM RIBETE

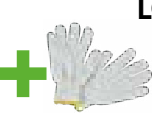
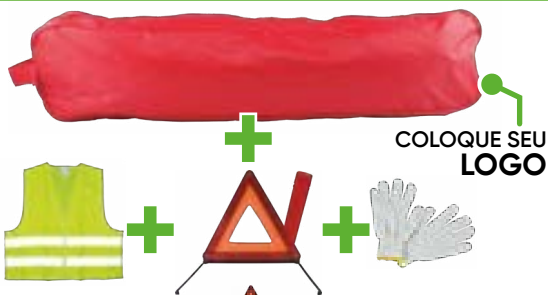

x1

x2

**53177** 14,20€

**53181** 21,70€

**53178** 14,20€

**53182** 21,70€

**53179** 14,20€

**53183** 21,70€

**53180** 14,20€

**53184** 21,70€

\* Duplo triângulo, obrigatório só em Espanha.

## KIT EMERGÊNCIA SACO PVC



x1

x2

**53185** 14,60€

**53186** 22,10€

\* Duplo triângulo, obrigatório só em Espanha.

## KIT EMERGÊNCIA SACO COM RIBETE

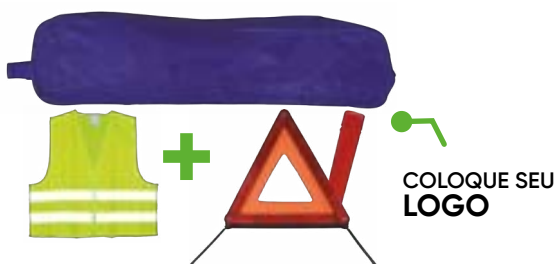

**53087** 13,50€

**53089** 13,50€

**53088** 13,50€

**53090** 13,50€

## KIT EMERGÊNCIA SACO



**53091** 14,00€

**53093** 14,00€

**53092** 14,00€

**53094** 14,00€





## KIT EMERGÊNCIA SACO

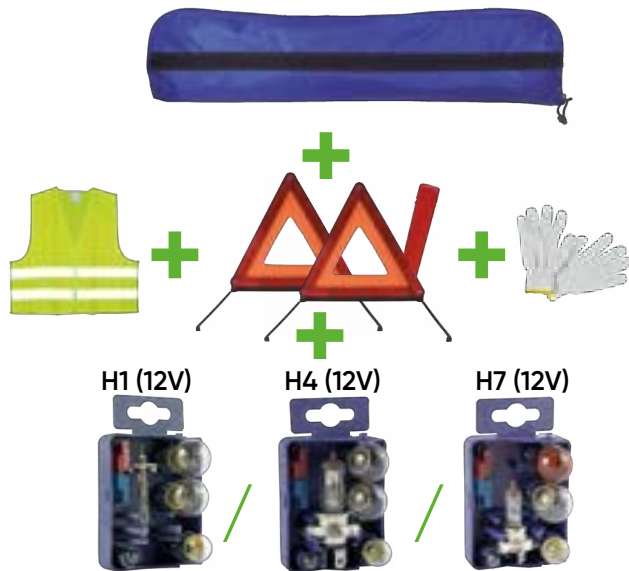

MK H1

Blue	52768	18,55€
Grey	52772	18,55€
Red	52776	18,55€
Black	52780	18,55€

MK H4

Blue	52769	20,50€
Grey	52773	20,50€
Red	52777	20,50€
Black	52781	20,50€

MK H7

Blue	52770	19,55€
Grey	52774	19,55€
Red	52778	19,55€
Black	52782	19,55€

MK H7+H1

Blue	52771	20,15€
Grey	52775	20,15€
Red	52779	20,15€
Black	52783	20,15€

\* Duplo triângulo, obrigatório só em Espanha.

## BALIZA DE EMERGÊNCIA LED

53721

0,16	20	80	1.440
------	----	----	-------

MODOS DE LUZ

- Inclui 2 modos de luz: **flash de emergência laranja** + função de iluminação com luz branca.

18,80€

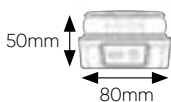

## TRIÂNGULO DE SINALIZAÇÃO HOMOLOGADO

53778

0,35	40	1.440
------	----	-------

4,50€

x1



52795

0,59	20	980
------	----	-----

6,00€

x1



## COLETE REFLECTOR HOMOLOGADO

51817

0,13	100	2.600
------	-----	-------

4,50€

50654

0,13	100	2.600
------	-----	-------

4,00€

50966

0,13	100	2.600
------	-----	-------

4,00€

Banda marcada

CUMPRE COM: EN ISO20471:2013



# KIT DE REPARO DE PUNÇÕES COMPRESSOR DE LÍQUIDO E AR

<b>54013</b>	1,15	5	20	240
29,00€				

- Veda furos de até 6 mm de diâmetro.
- Até 60 furos podem ser evitados aplicando líquido no pneu uma vez.
- O material não corrói metais e borracha.
- Fluido de longa duração, não inflamável e resistente ao congelamento.

## SELANTE DE PNEU - 500 ML

<b>15300</b>	0,55	12
5,00€		



## EXTRACTOR OBUSES

<b>11960</b>	0,01	10	500
1,50€			



## BOLSA PARA CONJUNTO

<b>15317</b>	0,01	500
4,50€		



## COMPRESSOR DE AR

<b>53150</b>	0,55	10	40	480
22,50€				



## CAPA IMPERMEÁVEL

<b>50525</b>	0,05	250	6.250
1,00€			



## PISTOLA PLÁSTICA PARA LATA DE SPRAY

<b>52493</b>	0,06	24
4,50€		

- Acessório útil para utilizar com a maioria de sprays do mercado.



## SPRAY TAPA FUROS

<b>51814</b>	0,03	12	1.320
7,99€			

- Para corrigir o pneu furado em menos de um minutose mudar a roda ou desmontar.



300ml

## ESPÁTULA TIRA GELO

<b>51697</b>	0,03	300	7.500
0,50€			



## GUARDA-CHUVA DOBRÁVEL

<b>50526</b>	0,2	100	2.000
4,50€			



## TIJERAS MINI DE 9 cm

<b>51925</b>	0,01	100	1.000	40.000
1,00€				



## MARTELO QUEBRA-VIDROS COM SUPORTE E CORTE DE CINTO DE SEGURANÇA

<b>52259</b>	0,16	50	100	2.000
3,50€				

135mm	20mm
75mm	∅ 160mm



## SOPORTE DE CELULAR PARA AUTO

<b>53443</b>	0,05	100
7,00€		



ENGATE

## ADAPTADOR USB PARA TOMA DE ISQUEIRO

<b>13815</b>	0,06	10	100
8,50€			



## LANTERNA DE DINAMO DE 2 LEDS

51573  
2,50€

0,07 12 96 3.456

6 Lm X2 LED



APRESENTAÇÃO  
CAIXA INDIVIDUAL

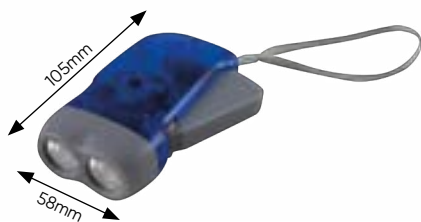

## LANTERNA DE DINAMO DE 3 LEDS

51446  
2,50€

0,08 12 96 3.456

10 Lm X3 LED



EM EXPOSITOR  
DE 12 UDS

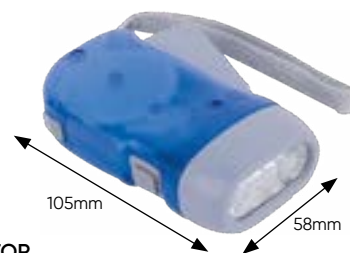

## SACO DE PVC COM ZÍPER/ FECHO

14918  
0,20€

0,01 2.400 38.400

25 x 30cm

14919  
0,50€

0,01 1.500

60 x 18 cm



## SET ORGANIZADOR DE MALETERO MULTIFUNCIONAL

52618  
52,00€

2,03 6 36

Composto per 4 peças:  
- Cofre flexível com tampa 37l (300mm x 490mm).  
- Bidon circular 180mm de Ø, com tampa (230mm altura).  
- Suporte porta objectos (90mm altura x 260mm amplo).  
- Bandeja rígida (175mm altura x 300mm larg).  
- Suporte porta objectos (90mm altura x 260mm amplo).



## JOGO DE 3 CAMURÇAS DE MICROFIBRAS

53221  
4,75€

0,03 50 800

360mm 360mm

3 PCS

- Conjunto de 3 camurças em microfibra, material 100% poliéster de alta qualidade.  
- Ideal para limpeza geral (espanar, desgordurar, polir...)  
- Grande capacidade de absorção de líquidos.  
- Sem deixar fios residuais.



IDEAL PARA  
LIMPEZA GERAL  
DE QUALQUER  
VEÍCULO



VÁRIOS  
APLICATIVOS

GRANDE CA-  
PACIDADE DE  
ABSORÇÃO DE  
LÍQUIDOS





## BOLSA DE PRIMEIROS SOCORROS - DIN13164

54042

0,41

10

13,00€



Um kit de primeiros socorros compacto, ideal para carro e transporte. Fornecido numa bolsa com zíper e velcro na parte traseira.

### Equipamento:

- Fita adesiva DIN13019-A 5x2,5
- 1 conjunto de 14 peças contendo:
  - 4 fitas adesivas DIN 13019-E 10x6
  - 2 adesivos elásticos para os dedos 4x7 cm
  - 2 adesivos elásticos para os dedos 12x2 cm
  - 2 tiras de fita adesiva à prova d'água 1,9x7,2 cm
  - 4 tiras de fita adesivas à prova d'água 2,5x7,2 cm
- 1 bandagem estéril DIN 13151-K 6x8 cm
- 2 bandagens estéreis DIN 13151-M 8x10 cm
- 1 bandagem estéril DIN 13151-G 10x12 cm
- 1 bandagem de primeiros socorros DIN 13152-BR 60x40 cm
- 1 bandagem de primeiros socorros DIN 13152-A 60x80 cm
- 2 bandagens estéreis DIN 61634FB6 6 cm x 400 cm
- 3 bandagens estéreis DIN 61634FB6 8 cm x 400 cm
- 1 manta de resgate 160x210 cm
- 6 compressas estéreis para feridas 10x10 cm
- 2 bandagens triangulares DIN 13168-D
- 1 tesoura DIN 58279-A145 145 cm
- 4 luvas descartáveis DIN EN 455-1
- 2 lenços umedecidos para limpar pele
- 1 lista de conteúdos
- 1 guia de primeiros socorros



## BOLSA DE PRIMEROS SOCORROS DIN13157

54072

1,6

10

38,50€



Este kit de montagem em parede inclui as âncoras necessárias para pendurar na parede.

### Contém:

- 1 gesso adesivo 5 x 25 - DIN13019-A
- 1 conjunto de bandagens adesivas 10 x 6 cm (8 unid.) - DIN13019-E
- 6 remendos de dedo 4 x 6,5 cm
- 6 remendos de dedo 120 x 20 mm
- 6 remendos de dedo 72 x 19 cm
- 12 remendos de dedo 25 x 72 mm
- 1 conjunto de bandagens de primeiros socorros, compressa estéril 6 x 8 cm - DIN13151-K
- 3 conjuntos de bandagens de primeiros socorros, compressa estéril 8 x 10 cm - DIN13151-M
- 1 conjunto de ataduras de primeiros socorros, compressa estéril 10 x 12 cm - DIN13151-G
- 1 compressa estéril (curativo de tratamento de queimadura) 60 x 80 cm - DIN13152-A
- 3 curativos esterilizados (compressas) 100 x 100 mm, 2 unidades / bolsa - DIN58953-2
- 2 tapa-olhos - 55 mm x 75 mm 1,5 g

- 1 compressa fria para tratamento de emergência, min. 200 cm<sup>2</sup>
- 1 manta de primeiros socorros, 160 x 210 cm, 12 microns
- 2 bandagens elásticas de acordo com os requisitos da norma (goze), 6 cm por 400 cm - DIN61634 FB6
- 2 bandagens elásticas de acordo com os requisitos da norma (goze), 8 cm por 400 cm - DIN61634 FB8
- 2 bandagens triangulares 96x96x136 cm - DIN13168-D
- 1 tesoura de metal 190 mm - DIN58279-B190
- 2 sacos de plástico para lixo, 300 x 400 mm, 45 microns
- 5 materiais não tecidos 20 x 30 cm, min. 15 g/H9m2
- 1 luvas descartáveis de PVC L-AQL1.5 (conjunto de 4) - DIN EN 455-1
- 1 livreto de informações



## CINTO DE SEGURANÇA PARA AUTOCARROS

CINTO DE 2 PONTOS

CUMPRE COM: E4-16R-0436213

CINTO DE 2 PONTOS ENROLÁVEL

CUMPRE COM: E4-16R-0436232

CINTO DE 3 PONTOS ENROLÁVEL

CUMPRE COM: E4-16R-0436232

50644

0,40

40

1.600

11,60€



1250mm

50717

0,75

20

500

21,00€



1330mm

51266

1,13

20

320

27,60€



2900mm



## BOLSA DE PRIMEROS SOCORROS

51246

0,2

50

600

6,40€



- 1 Folha de primeiros socorros.
- 1 tesoura.
- 1 Par de luvas de látex.
- 1 toalhita de sabão.
- 2 Toalhetas de álcool.
- 2 pensos para cortes.
- 25Gr. De algodão.
- 5 Pensos para queimaduras 20x20cm.
- 1 Liga.
- 1 rolo adesivo.
- Medidas saco: 180 x 130 x 55mm.



## FITA REFLEXIVA DE MARCAÇÃO PARA VEÍCULOS DE MERCADORIAS

51935

1,04

10

280

198,00€



51936

1,04

10

140

198,00€



51937

1,03

10

280

198,00€



50mm

50mm



HOMOLOGAÇÃO:  
REGLAMENTO CEPE/ONU 104R

IVA não incluído

JBM

www.jbmcamp.com

293

## CHAPA DE SINALIZAÇÃO V-20 "CARGA SUPERDIMENSIONADA"

- Placa para cargas salientes da parte traseira de qualquer veículo: caminhão / furgão / veículo turístico / ...  
- Com aprovação V20.

- Sinalização obrigatória em toda a Europa para transporte seguro.  
- Dimensões: 500x500mm.

**53636**

18,00€

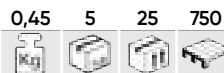

FEITO DE POLIPROPILENO  
PARA UMA MAIOR FLEXIBILIDADE

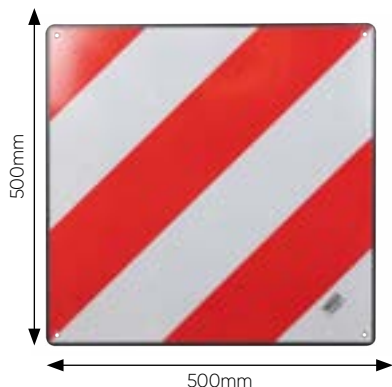

**53507**

24,00€



FRENTE EM POLIMETILMETACRILATO (PMMA) E TRASEIRA EM ALUMÍNIO

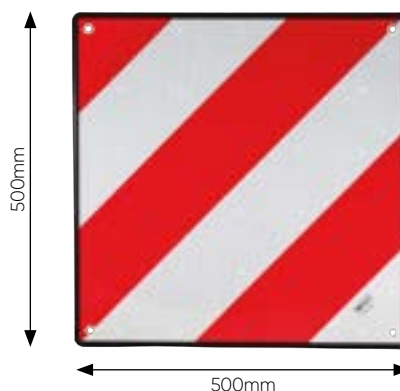

## CALÇO DE RODA

**53561**

28,00€



- Amarelo intenso para detectar visualmente fácil e rapidamente quando está sendo usado.

- **Peso leve:** fácil de transportar e manusear.

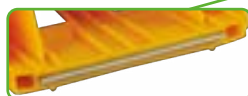
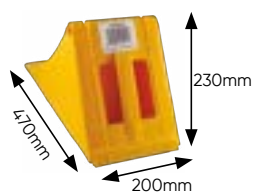

Com uma **tira de aço na base traseira** que **melhora sua fixação** e evita o deslizamento quando há gelo ou areia no pavimento.



SUPORE DE CALÇO DE RODA

**14118**

26,00€



## CALÇOS DE RODA

**53508**

14,00€



## PORTA-PLACA DE MATRICULA ANÔNIMA

**51412**

2,00€

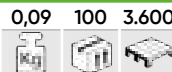

- Medidas : 53,20 cm x 13,70 cm.  
- Área de escrita : 52 cm x 1,60 cm.

FOTOLITO E TELA NÃO INCLUI





## PALA PLEGABLE

51858

0,96 20 320

15,00€



- Fabricado com metal resistente.
- Fexada: 240mm.
- Aberta: 600mm.



## PRORROGAÇÃO DE ALUMÍNIO PÁ

53033

0,63 5 65

15,50€



## PÁ METÁLICA COM CABO DE MADEIRA

52187

1,60 1 120

26,00€



215mm



## PÁ METÁLICA COM CABO DE MADEIRA

52251

1,74 1 120

26,00€



215mm



## SENSOR DE ESTACIONAMENTO COM MEDI- DOR DE APROXIMAÇÃO VISUAL E ACÚSTICO

51863

0,63 5 20 200

54,00€



- Voltagem nominal: DC 12 V.
- Potência: 3,6 W.
- Temperatura de trabalho: -20° a 70°.
- 4 sensores de aproximação.
- Distância de detecção: 0,3-2,0 m.
- Ângulo de detecção: H>60°, V>60°.
- Rádio frequência: 315 MHz / 433 MHz.
- Inclui indicador de 2 cores do marcador de aproximação.
- Sensores pretos. Não se podem pintar.



## CORDA MULTIUSOS 30M

53964

0,70 5 20 240

10,50€



Ø 1/4"

550 Kg

30M

53965

1,85 5 10 120

29,00€



Ø 1/2"

1.200 Kg



## SENSOR DE ESTACIONAMENTO COM ME- DIDOR DE APROXIMAÇÃO ACÚSTICO

51973

0,54 5 20 240

44,50€



- Voltagem nominal: DC 12 V.
- Potência: 3,6 W.
- Temperatura de trabalho: -20° a 70°.
- 4 sensores de aproximação.
- Distância de detecção: 0,3-2,0m.
- Ângulo de detecção: H>60°, V>60°.
- Rádio frequência: 315 MHz / 433 MHz.
- Sem indicador visual.
- Inclui buzzer de 4cm diâmetro.
- Sensores pretos. Não se podem pintar.



## SENSOR DE ESTACIONAMENTO 8 PINS

52742

0,91 5 20 120

64,00€



x8



- Alarme de voz disponível.
- 4 sensores traseiros (+ 4 da frente).
- Resistente à chuva.
- Peças disponíveis.
- Pins re-pintáveis.





## TAPETE DE BORRACHA UNIVERSAL - REVERSIBLE

**50585**

2,86 8 208

14,70€



- Borracha de alta qualidade.
- Muito resistente.
- Adaptável à maioria de veículos.



REVERSIBLE!



EXPOSITOR PARA TAPETE

**METEXP**

57,00€



## TAPETE DE BORRACHA UNIVERSAL

**53241**

1,65 12 288

9,00€



- Borracha de alta qualidade.
- Muito resistente.
- Adaptável à maioria de veículos.

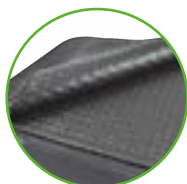

EXPOSITOR PARA TAPETE

**METEXP**

57,00€



## TAPETE DE TELA UNIVERSAL

**52530**

2 8 160

16,00€



- 2 frente (390mm) + 2 traseiras (365x480mm).
- Apresentação: Cabide.
- Leve, confortável, com salto.
- Reverso com pregos de borracha.



EXPOSITOR PARA TAPETE

**METEXP**

57,00€



REVERSO



## TAPETE DE TELA UNIVERSAL

### TALONERA COLOR ALUMÍNIO

**52534**

1,55 8 160

16,00€



- 2 frente (425x660mm) + 2 traseiras (295x425mm).
- Leve, confortável, com salto.
- Reverso com pregos de borracha.



### TALONERA TELA

**52535**

1,55 8 160

16,50€



EXPOSITOR PARA TAPETE

**METEXP**

57,00€



# ESCOVA DE LIMPADOR DE PARA-BRISA



**FÁCIL  
INSTALAÇÃO**

**GRANDE POTÊNCIA LIMPADORA  
DE ALTA VELOCIDADE**

**99%**

Fácil instalação do adaptador em mais de 99% dos veículos.

**38dB**

A ergonomia e a eliminação de peças de peso reduzem o ruído em 38db.

**30%**

Pressão uniforme em todo o comprimento da escova, graças à mola de aço para maior visibilidade do que os pincéis originais e desempenho superior de 30%.

**100%**

100% de borracha natural resistente a todas as condições climáticas extremas.

**160km/h**

Projeto aerodinâmico que permite o uso até 160 km/h.

**45°**

Ângulo de corte de 45° e precisão da limpeza transversal que elimina o maior número de quedas de gotas a mais.



**11 ADAPTADORES DIRE-  
FENTES:  
PARA VÁRIOS APLICATIVOS**



REF.	DESCRIÇÃO	📦	📦	📦	📦	€
53745	11" 280mm	0,20	10	50	800	6,00€
53746	12" 310mm	0,20	10	50	800	6,50€
53747	13" 330mm	0,20	10	50	600	6,50€
53748	14" 350mm	0,20	10	50	800	6,50€
53749	15" 380mm	0,20	10	50	800	6,50€
53750	16" 410mm	0,20	10	50	800	6,50€
53751	17" 430mm	0,20	10	50	550	7,00€
53752	18" 460mm	0,25	10	50	800	7,00€
53753	19" 480mm	0,25	10	50	600	7,00€
53754	20" 510mm	0,25	10	50	600	7,50€
53755	21" 530mm	0,25	10	50	600	7,50€
53756	22" 560mm	0,25	10	50	700	8,00€
53757	24" 610mm	0,25	10	50	550	8,50€
53758	26" 650mm	0,30	10	50	550	8,50€
53759	28" 700mm	0,30	10	50	550	8,50€
53760	30" 750mm	0,30	10	50	500	9,50€



**12  
PCS**

## EXPOSITOR

JBMWBEXP

1,07 10 100

24,50€



ESCOVAS DE  
LIMPA VIDROS

JBM

## CONTRAPESOS DE CLIP ADESIVA EM PASTILHA DE 45g. (TIRAS DE 5g - 10g - 5g - 10g - 5g - 10g)

<b>50600</b>	0,05	100	400	16.000
0,70€				
ZINC				

50600



<b>50601</b>	0,05	100	400	38.400
0,35€				
FERRO				

50601

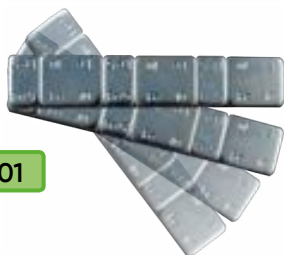

## ALICATE ESPECIAL PARA PESOS

<b>51355</b>	0,05	5	50	500
18,00€				

- Tira facilmente e substitui o peso.
- Corta e dobra com facilidade.
- Feito de aço reforçado.
- Inclui cabo ergonómico.
- Com mola automática para manter a sua abertura e facilitar a operação.



## CONTRAPESOS DE CLIP ADESIVAS EM PASTILHAS 60g

<b>52665</b>	<b>52666</b>
0,35€	0,35€

5gr x 12 u.

5gr x 4 u.

10gr x 4 u.

- Ferro.
- Adesive grande aderência e durabilidade.



52665

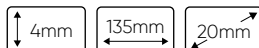

	0,06
	100
	400
	33.200



52666



	0,06
	100
	400
	30.000

## CONTRAPESO COM GRAPA DE ZINC ESPECIAL PARA JANTE UNIVERSAL

REF.	g.					€
50760	5g.	0,01	100	1.600	20.000	0,09€
50761	10g.	0,01	100	1.600	29.600	0,18€
50762	15g.	0,02	100	800	29.200	0,26€
50763	20g.	0,02	100	800	30.000	0,35€
50764	25g.	0,03	100	800	30.000	0,44€
50765	30g.	0,03	100	600	20.000	0,51€
50766	35g.	0,04	100	400	10.000	0,61€
50767	40g.	0,04	100	400	12.400	0,70€
50768	45g.	0,05	100	400	2.250	0,79€
51055	50g.	0,05	100	400	2.000	0,85€



## CONTRAPESO COM GRAPA DE ZINC ESPECIAL PARA JANTE ALUMINIO

REF.	g.					€
50778	5g.	0,01	100	1.600	20.000	0,09€
50779	10g.	0,01	100	1.600	10.000	0,18€
50780	15g.	0,02	100	1.200	6.600	0,26€
50781	20g.	0,02	100	800	5.000	0,35€
50782	25g.	0,03	100	800	4.000	0,44€
50783	30g.	0,03	100	600	3.300	0,53€
50784	35g.	0,04	100	400	2.850	0,61€
50785	40g.	0,04	100	400	2.500	0,70€
50786	45g.	0,05	100	400	2.250	0,77€
51604	50g.	0,05	100	400	2.000	0,75€



## CONTRAPESO UNIVERSAL CAMINHÃO

SEGMENTAÇÃO DE 50G					
<b>52667</b>	0,05	50	400	25.600	
0,64€					



SEGMENTAÇÃO DE 100G					
<b>52668</b>	0,1	25	200	12.800	
1,21€					



SEGMENTAÇÃO DE 150G					
<b>52669</b>	0,15	20	160	10.240	
1,80€					



SEGMENTAÇÃO DE 200G					
<b>52670</b>	0,2	10	80	5.120	
2,50€					



SEGMENTAÇÃO DE 250G					
<b>52671</b>	0,25	10	80	5.120	
2,97€					



SEGMENTAÇÃO DE 300G					
<b>52672</b>	0,3	10	80	5.120	
3,56€					





## DISPENSADOR DE CONTRAPESOS AUTO-ADESIVOS PASTILHAS DE FERRO DE 5g

- 1.000 pastilhas de 5g de Contrapesos de ferro. / Auto-adesivos 4mm espessura. / Medidas do dispensador: 29,5 cm x 29,5 cm.

**51908**

44,00€

5,82

4

204



Com imán de retenção dos contrapesos restantes.



**53256**

34,00€

5,3

4

216



## CAIXA DE CONTRAPESOS SURTIDO

**53864**

138,00€

10,50

1

71



CONTRAPESOS DE CLIP ADESIVAS EM PASTILHAS  
60gr: 4x10gr 4x5gr - 70u. (ref. 52666)

CONTRAPESOS DE ZINC COM GRAPA

PARA JANTE UNIVERSAL	PARA JANTE ALUMÍNIO
5g - 20 uds (ref. 50760)	5g - 20 uds (ref. 50778)
10g - 20 uds (ref. 50761)	10g - 20 uds (ref. 50779)
15g - 20 uds (ref. 50762)	15g - 20 uds (ref. 50780)
20g - 20 uds (ref. 50763)	20g - 20 uds (ref. 50781)
25g - 20 uds (ref. 50764)	25g - 20 uds (ref. 50782)
30g - 10 uds (ref. 50765)	30g - 10 uds (ref. 50783)
35g - 10 uds (ref. 50766)	35g - 10 uds (ref. 50784)
40g - 10 uds (ref. 50767)	40g - 10 uds (ref. 50785)



## VÁLVULAS TPMS

**12902**

5,70€

0,01

4

100



4.25 Nm  
OE 72-20-223



**12908**

5,70€

0,01

4

100



OE 72-20-205,  
TPK65654  
4.25 Nm



**12910**

5,70€

0,01

4

100



OE 72-20-206,  
TPK65655  
7.5 Nm



**12915**

15,50€

0,04

4

100



1.4 Nm (screw)  
8 Nm (nut) OE 72-20-116



**12920**

9,80€

0,02

4

100



4 Nm (screw)  
4 Nm (nut)



**12923**

9,80€

0,01

4

100



OE TPK43211  
8 Nm



**12924**

5,70€

0,01

4

100



1.4 Nm (screw)  
4.0 Nm (nut) OE 72-20-116



**12925**

9,80€

0,02

4

100



## KIT DE FERRAMENTAS PARA MONTAGEM E REMOÇÃO DA VÁLVULA TPMS

**52818** 1,38 10  
**168,00€**

- Definir múltiplas ferramentas especialmente concebidos para fácil montagem e desmontagem dos sensores TPMS.

- ① 2-14 NM
- ② 0,5-3,5 NM
- ③ 2xØ 11, 12mm
- ④ 3x T10, T15, T20
- ⑤ 150mm
- ⑥ 2mm
- ⑦ 0,25 Nm
- ⑧ 0,45 Nm

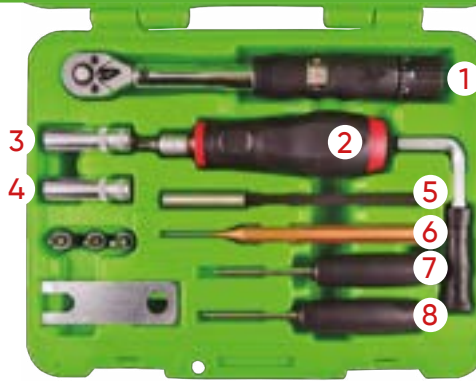

## FERRAMENTA PARA OBUSES

**52653** 0,04 10 250 6.000  
**3,00€**

- Para posicionar e desposicionar obuses.

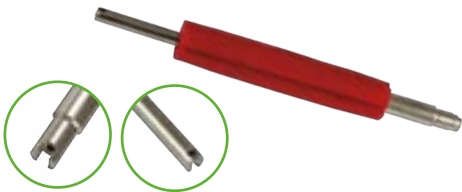

## CHAVE MULTIFUNCIONAL PARA OBUSES

**52652** 0,03 25 100 7.200  
**2,80€**



## SENSOR TPMS VÁLVULA DE GOMA

**53723** 0,04 4 EU-PRO HYBRID 3.5  
**68,00€**

- Fácil de programar.  
 - Adequado para 98% de todos os veículos no mercado.

- Torque de aperto da porca: parafuso.  
 - Torque de aperto do parafuso: 1,4 N\*m.



## JOGO DE TAMPÃO E OBUSES PARA PNEUS

**52673** 0,23 25 875  
**18,00€**



### TAMBÉM DISPONÍVEIS

**11900** 3,50€  
 Tampão de alumínio para válvula pneus. Blister de 4 unidades.

**11901** 2,50€  
 Tampão de plástico verde para válvula pneus. Blister de 4 unidades.

**11902** 3,50€  
 Tampão de plástico preto para válvula pneumática. Blister de 4 unidades.

### CONTÉM:

**11903** Saco 16 unidades tampão. Alumínio para válvula pneus.  
**5,00€**

**11905** Saco 50 unidades tampão. Plástico preto para válvula Pneu.  
**1,50€**

**11907** Saco 50 unidades obuses alta. Pressão.  
**11,00€**

**11904** Saco 50 unidades tampão. Plástico verde para válvula Pneu.  
**2,00€**

**11906** Saco 50 unidades obuses. Estandar.  
**8,50€**

**11960** Extractor obuses.  
**1,50€**

## SET DE REPARAÇÃO DE PNEUS

**52662** 0,66 10 440  
**36,50€**



- 1x Broca
- 1x Broca para inserir pavios
- 1x Util para encher pneus
- 4 x Garrafas de ar 16gr
- 1x Cuter
- 10 x Pavios
- 1x Chave multifuncionais obuses

**52663** 1,23 10 320  
**33,00€**



- 1x Broca para inserir pavios
- 1x Ponta para broca de pavios
- 1x Broca de perfuração
- 1x Cuter
- 20 x Pavios
- 1x Lubrificante

PAVIO DE SUBSTITUIÇÃO PARA REF. 52662 / 52663

**12973** 0,34 10 500  
**1,00€**

x5

BROCA DE PERFURAÇÃO REF. 52663

**13806** 0,35 5 50  
**10,50€**



BROCA DE INSERÇÃO DE PAVIOS REF. 52663

**13805** 0,5 50  
**10,50€**



## VÁLVULAS PARA JANTES

TR413

**51741**  
0,50€

0,01 100 1.000 48.000



x100



TR414

**51742**  
0,50€

0,01 100 1.000 48.000

TR418

**51743**  
0,55€

0,01 100 1.000 48.000



## FERRAMENTA PARA INSTALAR VÁLVULAS DE PNEUS

- Para posicionar válvulas de pneus.

METAL

**52649**  
5,00€

0,32  
10  
50  
2.250



PLÁSTICO

**52650**  
5,00€

0,12  
10  
100  
2.400



## FERRAMENTA DE REPARAÇÃO MULTIUSO

**52654**  
6,50€

0,24 25 100 800

- Chave umbrako: 4 - 3 - 2,5 - 2mm.
- Chave 12 lados: 9, 10, 12, 13, 15mm.
- Chave PH1.
- Chave SL1.
- Ponta umbrako 5-6mm.
- Chave de 6mm diam.



## ROLO PARA REPARAÇÃO DA PNEUMÁTICO

**52842**  
11,00€

0,15 10 100 1.500

38mm



## KIT DE 3 PROTETORES DE JANTES

**53419**  
9,00€

0,1 10 100 600

3 PCS



## CHAVE CRUZ JUNTA SOLDADA

**51661**  
11,50€

1,17 5 20 480

355mm

1/2"

17, 19, 21mm

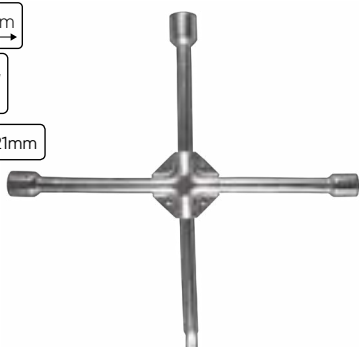

**52881**  
17,00€

1,4 10 420

400mm

1/2"

17, 19, 21, 22mm

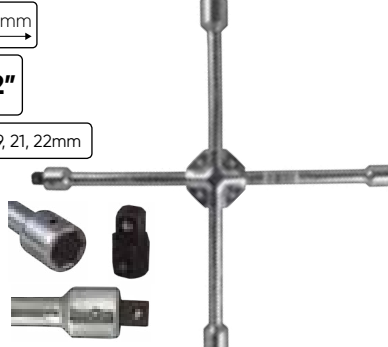

**52880**  
38,50€

3,75 5 100

700mm

3/4"

24, 27, 32mm

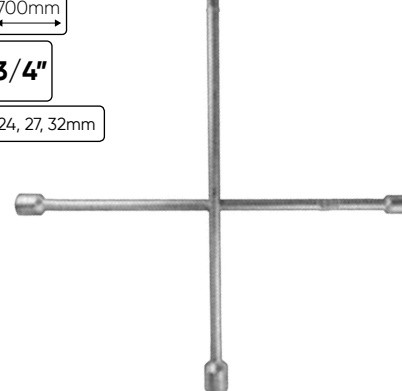

## CHAVE DE RODAS EXTENSÍVEL COM CHAVES REVERSÍVEIS

**51416**  
12,00€

1,09 10 20 600

330-490mm

1/2"



CHAVE CROMADA

21mm / 23mm

17mm / 19mm



## FERRAMENTA PARA A MUDANÇA DE PNEUS PARA REMOVER PNEUS

**52657**  
37,90€

0,18 20 800



**52658**  
37,90€

0,16 20 800



**52659**  
37,90€

0,26 20



## AVALANCA PLASTICA DE REMOVER PNEUS

**52655**  
37,00€

0,39  
25  
1.500

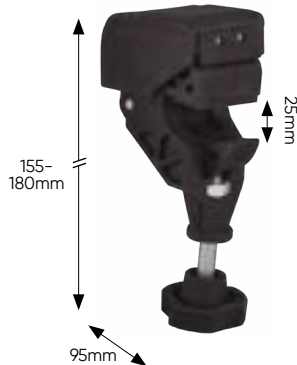

**52656**  
29,50€

0,4  
5  
20



## ALAVANCA PARA PNEUMÁTICOS

**51362**  
3,00€

0,19  
5  
60  
500

12"  
304,8mm

**51358**  
7,50€

0,5  
6  
24  
1.008

16"  
406,4mm

**51359**  
9,00€

0,66  
6  
24  
1.008

24"  
609,6mm

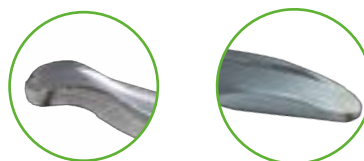

## TROCADOR DE PNEU MANUAL

**53605**  
141,00€

16 1 21

950mm

- Integridade:  
1 manivela para quebrar o talão do pneu de 37 polegadas de comprimento.  
Ferramentas montadora / desmontadora.

- Aplicabilidade:  
todos os pneus de 8 polegadas até pneus para caminhões ligeiros (7-1/2 polegadas x 16 polegadas).

- Passabilidade:  
até 12.5L 16.

## ALAVANCA DE MUDANÇA DE RODAS INDUSTRIAIS

**52664**  
168,00€

12,3 2 18





## KIT DE FOLAS DE TRANSMISSÕES

PARA TURISMO

**51705**

0,23 1 20 320

7,00€



PARA CARRINHAS

**51703**

0,28 20 280

8,50€



REPOSIÇÃO PARA  
REF. 51703

**13739**

0,08 150

5,00€



REPOSIÇÃO PARA  
REF. 51705

**13738**

0,08 150

3,00€



## KIT DE FOLAS DE TRANSMISSÕES UNIVERSAL

**52644**

0,19 20 240

7,50€



NEOPRENO



LUBRIFICANTE PARA O  
KIT UNIVERSAL DA MAN-  
GA DE PROTEÇÃO

**13880**

1,20€



REPOSIÇÃO  
PARA REF. 52644

**13740**

5,00€



## ABRAÇADEIRAS

**11891**

0,01  
100  
5.000

0,50€

x100

15-45mm



**11890**

0,02  
100  
1.000  
20.000

0,55€

x100

50-125mm



## PACK DE 2 ABRAÇADEIRAS

**52633**

0,02 100 800 16.000

1,00€

UTILIZAR COM ALICATES  
REF. 52619.

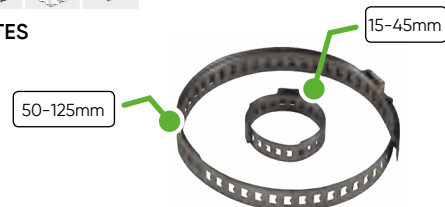

## CASQUILHO CENTRADOR PARA RODAS DE PESADOS

REF.	kg	Box	Tray	Quantity	€
52645	0,02	50	1.000	38.000	0,55€
52646	0,01	50	1.000	80.000	0,50€
53037	0,01	50	1.000	-	0,50€
53038	0,01	50	1.000	-	0,50€
53039	0,02	50	1.000	-	0,50€
53040	0,01	50	1.000	-	0,50€

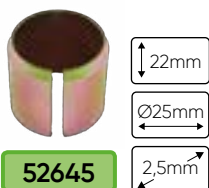

x50

## TUBOS FLEXÍVEL INNERBRAID



DISPONÍVEL EM  
CAIXA INDIVIDUAL

REF.	DESCRIÇÃO	kg	Box	Tray	Quantity	€
51706	Ø 25mmL x 300mmL	0,27	25	1.500	19,50€	
51707	Ø 45mmL x 100mmL	0,27	25	1.200	9,00€	
51708	Ø 45mmL x 150mmL	0,41	25	900	13,00€	
51709	Ø 45mmL x 200mmL	0,49	25	750	14,00€	
51710	Ø 45mmL x 250mmL	0,65	25	600	16,50€	
51711	Ø 45mmL x 300mmL	0,81	25	450	19,50€	
51712	Ø 50mmL x 100mmL	0,26	25	700	9,60€	
51713	Ø 50mmL x 150mmL	0,46	25	700	12,00€	
51714	Ø 50mmL x 200mmL	0,59	25	600	15,80€	
51715	Ø 50mmL x 250mmL	0,73	25	600	19,00€	
51716	Ø 50mmL x 300mmL	0,83	25	450	22,30€	
51717	Ø 55mmL x 100mmL	0,35	25	700	11,20€	
51718	Ø 55mmL x 150mmL	0,47	25	450	13,60€	
51719	Ø 55mmL x 200mmL	0,63	25	350	20,50€	
51720	Ø 55mmL x 250mmL	0,82	25	350	22,00€	
51721	Ø 55mmL x 300mmL	0,88	25	375	23,30€	
51722	Ø 60mmL x 100mmL	0,37	25	700	13,05€	
51723	Ø 60mmL x 150mmL	0,5	25	500	17,00€	
51724	Ø 60mmL x 200mmL	0,64	25	400	22,50€	
51725	Ø 60mmL x 250mmL	0,79	25	300	25,60€	
51726	Ø 60mmL x 300mmL	0,96	25	250	33,00€	
51727	Ø 60mmL x 400mmL	1,62	25	200	44,00€	





306

CÂMARAS TÉRMICAS E TERMÔMETROS

308



DISPENSADORES

310



LIMPEZA DE SUPERFÍCIES

311



LIMPADORES E FÓRMULAS HIDROALCOÓLICAS

311



POSTES DE SEPARAÇÃO

312



DESINFECÇÃO DE ESPAÇOS

313



MEDIDOR DE OZÔNIO

314



# SEGURANÇA E EPI



## LUVAS COM PALMA REFORÇADA DE POLIURETANO

<b>REF.</b>	0,03	12	144	3.456	
2,00€		UDS			
		PACK			

51640N T. 8

51642N T. 9

51636N T. 10

51638N T. 11



## LUVAS COM PALMA REFORÇADA DE NITRILO

<b>REF.</b>	0,04	12	144	3.456	
2,00€		UDS			
		PACK			

51633 T. 8

51634 T. 9

51632N T. 10

51398N T. 11



## LUVAS DE PELE E PANO

<b>52310</b>	0,19	12	120	1.200	
4,00€		UDS			
		PACK			



## LUVAS DE PELE

<b>52738</b>	0,1	12	144	2.880	T. 9
5,00€					



<b>52739</b>	0,1	12	144	2.880	T. 10
5,00€					



## LUVAS ANTI-CORTE TACTILES

<b>52570</b>	T. 8	
4,00€		

0,03	12	144	3.456	EN 388
				3131X

<b>52571</b>	T. 9	
4,00€		

0,03	12	144	2.592	EN 388
				3131X

<b>52572</b>	T. 10	
4,00€		

0,03	12	144	2.592	EN 388
				4131

<b>52573</b>	T. 11	
4,00€		

0,04	12	144	2.592	EN 388
				4131

PARA TELA DE TOQUE



## LUVAS DE ALGODÃO COM PALMA REFORÇADA DE PONTOS DE BORRACHA

<b>51785</b>	0,04				CE
0,75€		UDS			
		PACK			

12	300	4.200

PALMA REFORÇADA



## LUVAS DE ALGODÃO

<b>51745</b>	0,05				CE
0,70€		UDS			
		PACK			

12	144	3.744





# LUVAS DESCARTÁVEIS DE NITRILO

REF.	DESCRIÇÃO	Ícone 1	Ícone 2	Ícone 3	€	<b>NOVO</b>
<b>3.5 MIL</b>						
42446	S	0,40	100	10 500	14,80€	
53984	M	0,50	100	10 400	14,80€	
53985	L	0,50	100	10 400	14,80€	
53986	XL	0,55	100	10 400	14,80€	



REF.	DESCRIÇÃO	Ícone 1	Ícone 2	Ícone 3	€	<b>NOVO</b>
<b>4.0 MIL</b>						
53989	M	0,70	100	10 500	17,80€	
53990	L	0,70	100	10 500	17,80€	
53991	XL	0,70	100	10 500	17,80€	



REF.	DESCRIÇÃO	Ícone 1	Ícone 2	Ícone 3	€	<b>JBM</b>
<b>5.0 MIL</b>						
52681	M	0,62	100	10 340	15,80€	
52682	L	0,62	100	10 340	15,80€	
52683	XL	0,67	100	10 340	15,80€	



REF.	DESCRIÇÃO	Ícone 1	Ícone 2	Ícone 3	€	<b>NOVO</b>
<b>5.5 MIL</b>						
53994	M	0,50	50	20 560	14,90€	
53995	L	0,50	50	20 560	14,90€	
53996	XL	0,55	50	20 560	14,90€	



REF.	DESCRIÇÃO	Ícone 1	Ícone 2	Ícone 3	€	<b>JBM</b>
<b>7.0 MIL</b>						
53551	M	0,90	100	10 300	19,80€	
53552	L	1	100	10 300	19,80€	
53553	XL	1	90	10 300	19,80€	



## REFLECTOR HOMOLOGADO

<b>53788ES</b>	0,12	100	2.600
3,95€	Ícone 1	Ícone 2	Ícone 3

**DISPONÍVEL EM QUALQUER LÍNGUA**

<b>51817</b>	0,13	100	2.600
4,50€	Ícone 1	Ícone 2	Ícone 3

Banda marcada

<b>50966</b>	0,13	100	2.600
4,00€	Ícone 1	Ícone 2	Ícone 3

Inclui mensagem para manter a distância de segurança entre as pessoas



<b>50654</b>	0,13	100	2.600
4,00€	Ícone 1	Ícone 2	Ícone 3



**HOMOLOGADO ISO20471:2013**

## TELA DE PROTEÇÃO DE METACRILATO

<b>53835</b>	38,00€
--------------	--------

2,30	8	108
Ícone 1	Ícone 2	Ícone 3
70cm	50cm	

<b>53836</b>	58,00€
--------------	--------

4,05	5	60
Ícone 1	Ícone 2	Ícone 3
70cm	100cm	

<b>53899</b>	12,00€
--------------	--------

2,30	8	108
Ícone 1	Ícone 2	Ícone 3
50cm	70cm	

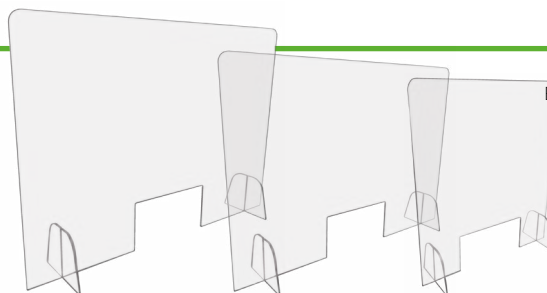

Espessura: 5mm  
Buraco: 300x160mm  
Base: 150x200mm



## ÓCULOS DE DESPORTO DE SEGURANÇA - ANTI-NEVOEIRO

0,01 12 144 2.016



CUMPRE COM: EN166:2002-04 / EN166:2003-01

53598

4,00€

53596

3,50€

53597

3,50€



53596, 53597, 53598



53597

EM EXPOSITOR DE 12 UDS

## MÁSCARA DE PROTEÇÃO CONTRA EMBACAMENTO

53798

1,95€

0,04 25 200 1.800



De acordo com a EN166

Proteção direta contra líquidos e bactérias.

- Espuma no interior para melhorar o conforto.
- Tratamento anti-névoa na tela.
- Ajustável.



## AUSCULTADORES PARA PROTEÇÃO AUDITIVA

52430

12,50€

0,34 6 24 240



PVC



ABS

CUMPRE COM: EN352 - 1:2003

## CÂMARA DE TERMOGRAFIA

53795

1.450,00€

0,80 5



Em conformidade com: EN61326-1:2013, EN61326-2-2:2013, EN61326-2-3 ROHS

Faixa de temperatura:

30° - 45° C

Precisão:

± 0,5°C

Distância de medição ideal:

1 metro

Resolução:

0,1°C

Resolução térmica:

160x120

quer ver como funciona?

VIDEOTUTORIAL DISPONÍVEL EM

YouTube



14786

48,00€

1,10 10



TRIPÉ PARA REF. 53795



Software de monitorização



## ÓCULOS DE SEGURANÇA - ANTI-NEVOEIRO

53785

4,80€

0,05 14 112 896



CUMPRE COM: EN166:2002-04

- Proteção direta contra líquidos e bactérias.
- Alça elástica ajustável.
- Tratamento de lentes anti-embaçamento.

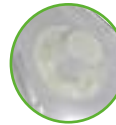

Válvulas incorporadas para evitar o vácuo no interior.



## ÓCULOS DE PROTEÇÃO SOLAR

52445

3,85€

0,06 12 300 1.800



CUMPRE COM: EN166:2001



PC

## TERMÓMETRO DE INFRAVERMELHOS

53794

36,20€

0,15 80 1.200

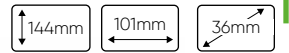

- COMPOSTO CON ALARME SONORO
- INCLUI SMART CHIP E MEMORIZA ATÉ 32 REGISTOSSES
- ÉCRAN PARA FACILITAR A VISUALIZAÇÃO

- Mede a temperatura corporal em **1 segundo e sem contato**.
- Desligamento automático após 1 minuto.

Temperatura corporal 32,0°C - 42,2°C (89,6°F - 108°F)

Precisão ±0,2°C (35°C - 42°C)



distância de medição: 15 - 50mm



2 pilhas A INCLUIDO

CE 0123

## CÂMERA COM SISTEMA DE MEDIÇÃO DE TEMPERATURA

53830

2.996,00€

3,15 1



Potência:

12VDC

Internet:

RJ45

Relay :

+ :NO - :COM

Funciona por conexão IP



Audio Relay Internet Power



Software de monitorização

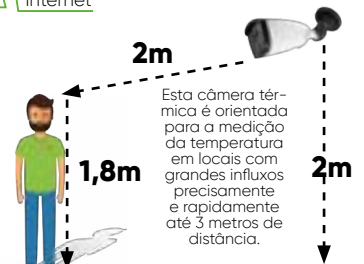

Esta câmara térmica é orientada para a medição da temperatura em locais com grandes influxos precisamente e rapidamente até 3 metros de distância.

VIDEOTUTORIAL DISPONÍVEL EM

YouTube



# MÁSCARA DE PROTEÇÃO CONTRA EMBAÇAMENTO

## FFP2

- Arco de alumínio para fácil adaptação ao nariz.
- Design arqueado para uma respiração mais suave.
- Elástico de borracha fácil de prender.

**53787**

0,01 10 800 9600



0,58€

**ANTI-NEVOEIRO**



## COM VÁLVULA

**53844**

0,02 3 360 1.440



2,80€

Servido em caixas de 3 unidades



Penetração do material do filtro	≤ 6%
Vazamento total	≤ 11%
Resistência respiratória máx.	30l/min (inspiração): ≤ 0.70 mbar 95l/min (inspiração): ≤ 2.4 mbar 160l/min (expiração): ≤ 3 mbar



- Material filtrante de várias camadas.
- Selo nasal de espuma de poliuretano.
- Forro interno que melhora a vedação e o conforto.



Apresentação em sacos de 10 unidades.



Aprovado de acordo com o regulamento da UE 2016/425  
Está em conformidade com a norma EN149:2001



**95% EFICÁCIA DO EFB NA FILTRAÇÃO BACTERIANA**

Aprovado de acordo com o regulamento da UE 2016/425  
Está em conformidade com a norma EN149:2001+A1:2009

<b>53946</b>	<b>537870</b>
0,78€	0,78€
<b>53959</b>	<b>53960</b>
0,78€	0,78€
<b>53961</b>	<b>53963</b>
0,78€	0,78€

0,01 10 1000 9000



Apresentação em sacos de 10 unidades.

Penetração do material do filtro	≤ 6%
Vazamento total	≤ 11%
Resistência respiratória máx.	30l/min (inspiração): ≤ 0.70 mbar 95l/min (inspiração): ≤ 2.4 mbar 160l/min (expiração): ≤ 3 mbar



Aprovado de acordo com o regulamento da UE 2016/425  
Está em conformidade com a norma EN149:2001+A1:2009

## FFP3

**53916**

0,03 10 200 1.600



3,80€

- Material de filtro de três camadas (polipropileno).
- Um clipe nasal que garante um ajuste confortável da meia máscara no rosto.
- Válvula de expiração.
- Laços elásticos com elásticos naturais, sem látex.
- Fechos plásticos.
- Revestimento interno para melhor vedação e conforto.



Aprovado de acordo com o regulamento da UE 2016/425  
Está em conformidade com a norma EN149: 2001

Penetração de solução salina (cloreto de sódio) ou partículas de névoa de óleo no material do filtro	≤ 1%
Tempo máximo de uso	8 h

VÁLVULA DE EXPIRAÇÃO EMBUTIDA

## DE UN SOLO USO

### MÉDICA IIR

**53907**

0,01 50 2.000 24.000



0,16€

Eficácia do EFB na filtração bacteriana	>90%
Resistência à respiração	35~50 Pa

USO MÉDICO

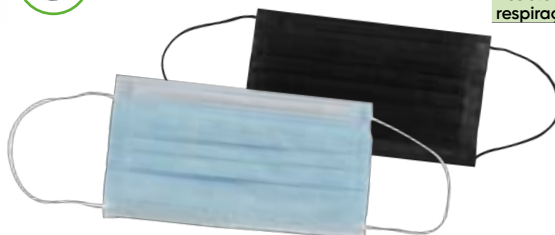

EN 14683: 2019+AC:2019  
EN ISO 13485:2016  
EN ISO 11737-1:2018  
ISO 22609:2004

### HIGIÊNICA

**53797**

0,01 50 2.000 24.000



0,10€

Eficácia do EFB na filtração bacteriana	>90%
Resistência à respiração	35~50 Pa

USO NÃO MÉDICO

UNE 0064-1:2020



Apresentação em caixa com 5 sacos de 10 cada.

## TAPETE PARA DESINFECÇÃO DE CALÇADO

### ALCATIFA COM TANQUE

PARA LÍQUIDO DESINFECTANTE

**53862**

51,00€

1,45 5 100



- Medidas: 85x55x10cm
- Material: TPE
- Capacidade máxima recomendada: 3L
- Capacidade máxima: 8L



### TAPETE DE SECAGEM

**53863**

15,50€

0,70 5 240



- Medidas: 76x48cm
- Material: Poliéster

LÍQUIDO PARA TAPETE 53862

**53893**

21,00€

4,50 4 128



## DISPENSADOR DE CAPA DE SAPATO AUTOMÁTICO

**53781**

28,00€

2,20 8 32



- Permite cobrir os pés com tampas plásticas apenas colocando-os dentro do dispensador.
- Na parte inferior existem 8 peças de PVC para melhor aderência.

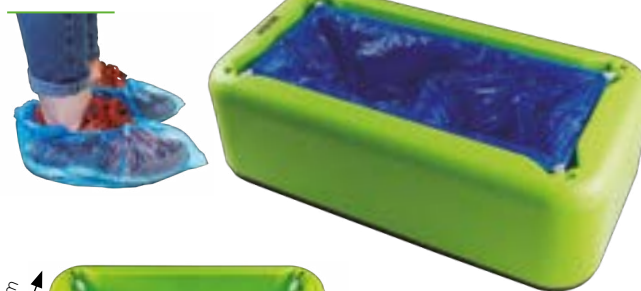

TAMPA DO SAPATO 100PCS

**14781**

9,90€

0,25 84 336



## DISPENSADOR AUTOMÁTICO 1200ml

**53902**

49,00€

1,15 18 144



- Dosagem: ajustável de 0,5 ml a 2,5 ml.
- Compatível com sabonete líquido, álcool, desinfetante para mãos e gel.
- Medidas: 100x110x220mm.

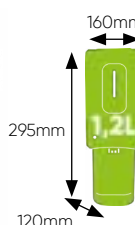

DISTÂNCIA DE ATIVAÇÃO SENSOR: 50-150MM

ADAPTADOR AC/DC 6V 1.5A

**15059**

10,00€

0,10 200



BATERIA R14 C1.5V

**15062**

1,00€

0,01 24 480



Inclui suporte e parafusos para fixação na parede.

## DISPENSADOR AUTOMÁTICO 400ML

**53826**

26,00€

0,35 40 400



- Compatível com sabonete líquido, álcool, gel e desinfetante para as mãos.
- Sensor de movimento infravermelho inteligente.
- Dosagem: 1ml.
- Tensão: 6V (4 pilas de 1,5V).
- Pilhas não incluídas.



DISTÂNCIA DE ATIVAÇÃO SENSOR: 5 CM



BASE À PROVA D'ÁGUA: COM UM ANEL DE SILICONE FLEXÍVEL NA TAMPA INTERNA

## SUPOORTE PARA DISPENSADOR DE GEL AUTOMÁTICO

**53827**

67,00€

4,80 1 42



- Peso: 4.3kg
- Material: Aço
- Cor: preta
- Medidas da bandeja: 417x67mm
- Medidas do suporte do dispensador: 480x133mm
- Diâmetro da base: 395mm

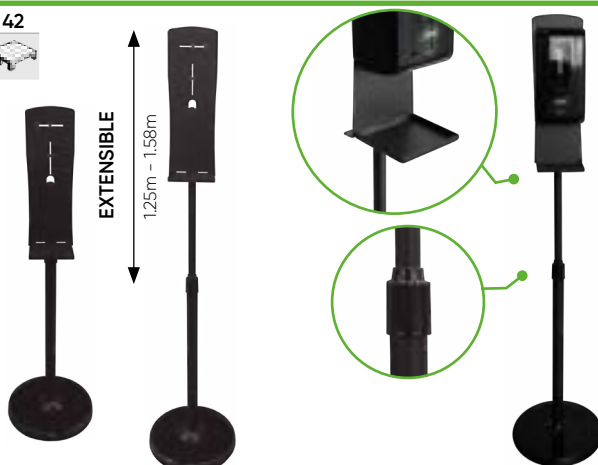

## DISPENSADOR PARA GARRAFA

**14793**

18,60€

0,05 100 1.200



## SACO DE PVC COM ZÍPER/ FECHO

**14918**

0,20€

0,01 100 2.400 38.400



25 x 30cm



**14919**

0,50€

0,01 1.500



60 x 18 cm





# LÍQUIDO DE LIMPEZA DE SUPERFÍCIES

## FORMATO LÍQUIDO



5L

**53829**  
24,00€

4,45 4 128

1L

**53828**  
7,30€

0,90 12 324

## FORMATO SPRAY

limpa todos os tipos de superfícies:  
home - carro - escritório - AACC

- Spray ideal para limpar todos os tipos de superfícies.
- Aspecto físico: Líquido transparente.
- Contém: Isopropanol / Etanol.



500ml

**53824**  
9,00€

0,40 24 1.152



100ml

**53804**  
1,80€

válidos para  
AACC

0,10 35 2.940

## PISTOLA PLÁSTICA PARA LATA DE SPRAY

Acessório útil para utilizar com a maioria de sprays do mercado.



**52493**  
4,50€

0,06 10 150 600

# CUIDADOS E HIGIENE DAS MÃOS: LIMPADORES E FORMULAS HIDROALCOLÓGICAS

## FORMATO GEL

- Higiene e limpeza profunda.
- Máxima eficácia com **álcool**.



- Contém:  
propan-2-ol, alcohol  
isopropílico / Etanol /  
propan-1-ol, n-propanol

### Como usar:

Aplique uma quantidade suficiente de produto na pele saudável e seca e esfregue por pelo menos 30 segundos. Não precisa ser enxaguado.



60ml

**53832**  
1,90€

0,65 24 48 3.360



500ml

**53791**  
5,80€

0,47 6 576



5L

**53790**  
19,80€

4,30 4 128

## FORMATO LOÇÃO

### válido para superfícies

- Solução hidroalcoólica com **glicerina e aloe vera** para higiene e cuidados com as mãos.



**53822**  
4,80€

0,45 19 760

0,5L



## FORMATO ESPUMA

**53803**  
1,80€

0,15  
35  
3.780

100ml



Produto cosmético ideal para limpar e higienizar as mãos.

Graças à sua formulação, limpa e desinfeta as mãos rapidamente e proporciona uma sensação imediata de bem-estar e suavidade à pele. O produto aplicado não requer enxágue, não graxa, não cola e garante uma higiene profunda para si e para os outros.



## POSTE DE SEPARAÇÃO COM FITA RETRÁCTIL

53914

75,60€

8,5

5



- Material: aço
- Diâmetro do tubo: 63 mm
- Diâmetro da base: 320 mm
- Altura: 910 mm
- Fita de 4 lados
- Comprimento da correia: 3 m
- Largura da correia: 48 mm

910mm



FITA DE 4 LADOS

## FITA DE SINAL

200M

53811

15,90€

0,45



200M X 10cm



53987

8,30€

0,59



200M X 10cm



## POSTE DE PLÁSTICO PARA CADEIA ALTA TENSÃO

53940

13,20€

0,55

6

96



- Material: PVC.

CADEIA NÃO INCLUÍDA

- ✓ Para uma vedação simples, rápida e móvel de áreas interiores e exteriores com limitações.
- ✓ Suas cores contrastantes tornam a corrente altamente visível para restringir áreas de alta tensão.



ESPECIAL  
SINALIZAÇÃO DE ALTA  
TENSÃO



850mm

BASE INFLÁVEL



## ELO DE FECHAR

53942

0,50€

0,01

50

5.000

75.000



## CADEIA DE PVC

53941

5,75€

0,30

40

600



- Comprimento: 5m
- Link: 6mm
- Cor: Vermelho / Branco

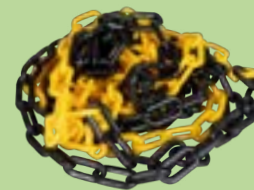

## POSTE DE PLÁSTICO PARA CADEIA

53808

16,50€

0,55

6

120



- Material: PVC.

CADEIA NÃO INCLUÍDA



BASE INFLÁVEL



850mm

## ELO DE FECHAR

53839

0,25€

0,01

10

2.000



## CADEIA DE PVC

53809

8,00€

1,30

40

560



- Comprimento: 5m
- Link: 6mm
- Cor: Vermelho / Branco

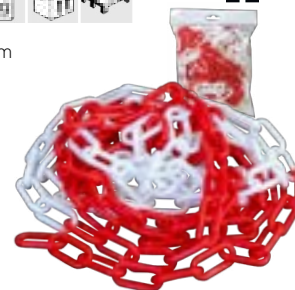

## FITA ADESIVA DE SINALIZAÇÃO DISTÂNCIA DE SEGURANÇA

53840ES

9,80€

0,05

10

360



1.000x1.000 mm

DISPONÍVEL  
EM QUALQUER  
LÍNGUA

- Texto:  
"¡POR FAVOR! MANTENHA A DISTÂNCIA SEGURANÇA"

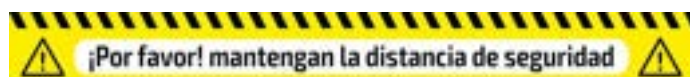

## ADESIVO REDONDO DISTÂNCIA DE SEGURANÇA

53843ES

8,35€

0,05

60



Ø 400mm

DISPONÍVEL  
EM QUALQUER  
LÍNGUA

- Texto:  
"POR FAVOR, MANTENHA A  
DISTÂNCIA SOCIAL DE SEGU-  
RANÇA, ESPERE AQUI"

Antiderrapante





# GERADOR PORTÁTIL DE OZÔNIO

Desinfecta o ar em salas usando ozônio O3 para oxidar praticamente qualquer partícula: vírus, bactérias, componentes orgânicos e inorgânicos.

Uso em áreas desocupadas



HIGIENE

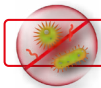

ANTI BACTERIAS



PURIFICA

APLICAÇÕES AMPLAS:



CASA



ESCRITÓRIO



CAMIONETAS



CAMIÕES

5.000mg/h

**53786**

128,00€



Tempo de operação recomendado de acordo com o tamanho da sala:

50m³	100m³	150m³	200m³	300m³
20min	40min	60min	80min	100min

PLACA PARA REF. 53786

**14775**

30,50€



600mg/h

**53796**

99,15€



Tempo de operação recomendado de acordo com o tamanho da sala:



IDEAL PARA VEÍCULOS

LEVE, RÁPIDO E PODEROSO

BAIXO NÍVEL DE RUÍDO

TAMANHO PORTÁTIL



Conexão à eletricidade e ligação à tomada do isqueiro.

10.000mg/h

**53805**

220,00€



- Leve, rápido e poderoso.
- Baixo nível de ruído.
- 3 tipos de desinfecção: ozônio, íon, ozônio + íon
- Modelo com temporizador e espera
- Tamanho portátil com alça.

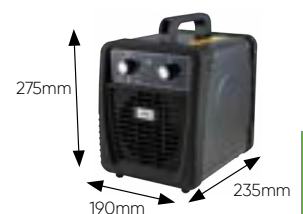

PLACA PARA REF. 53805

**14802**

44,00€



Volume do quarto	Tempo de trabalho necessário
50m³	8 min
100m³	16 min
150m³	24 min
200m³	32 min
300m³	48 min



# GERADOR PORTÁTIL DE OZÔNIO

10.000mg/h - 20.000mg/h

53806

290,00€

3,90

4

32



- Leve, rápido e poderoso.
- Baixo nível de ruído.
- Filtro de ar e placa de ozônio facilmente substituíveis.
- Tamanho portátil com alça.
- Dissipador de calor para evitar superaquecimento na placa de ozônio.



PLACA PARA REF. 53806

14803

42,50€



**INCORPORA LUZ UV PARA ESTERILIZAR**

## 2 MODOS DE POTÊNCIA

LOW 10.000mg/h		HIGH 20.000mg/h	
Volume do quarto	Tempo de trabalho necessário	Volume do quarto	Tempo de trabalho necessário
50m <sup>3</sup>	8 min	500m <sup>3</sup>	30 min
100m <sup>3</sup>	16 min	600m <sup>3</sup>	40 min
150m <sup>3</sup>	24 min	700m <sup>3</sup>	50 min
200m <sup>3</sup>	32 min	800m <sup>3</sup>	60 min
300m <sup>3</sup>	48 min	900m <sup>3</sup>	70 min
500m <sup>3</sup>	65 min	1.000m <sup>3</sup>	80 min

# CAIXA ESTERILIZADORA DE DESINFECÇÃO

53838

48,00€

1,10

8

96



- ✓ HIGIENE
- ✓ PODEROSO

- ✓ SEGURO E EFICAZ
- ✓ ELIMINA OS MAUS ODORES

- ✓ RÁPIDO
- ✓ TRANSPORTÁVEL



TEMPO DE DESINFECÇÃO



BOLSILLO POSTERIOR



DESMTABLE

A caixa se monta e desmonta facilmente, facilitando assim seu transporte.

- Comprimento de onda ultravioleta: 254 nm
- Tomada de alimentação: conector micro USB

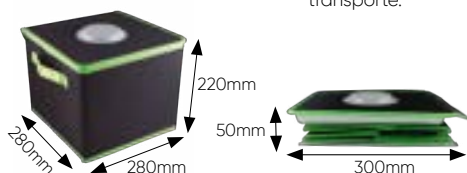
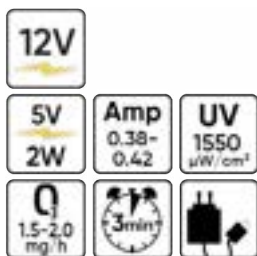

# MEDIDOR DE OZÔNIO

53802

290,00€

0,65

20

240



- Precisão:  $\pm 5\%$  F.S.
- Faixa de medição: 0-50ppm (0-98mg/m<sup>3</sup>)
- Alarme baixa: 5ppm (98mg/m<sup>3</sup>)
- Alarme alta: 10ppm (196 mg/m<sup>3</sup>)
- Tempo de resposta: <30 segundos
- Faixa de temperaturas operacionais: -10°C - 55°C
- Proteção: IP65

DOIS NÍVEIS DE ALARME CONFIGURÁVEIS PARA DIFERENTES NÍVEIS DE CONCENTRAÇÃO



TEMPO DE OPERAÇÃO: >8H

TEMPO DE CARREGAMENTO: 4H-6H



109x60x30mm

CE

em conformidade com: EN61326-1, EN61000-4-2, EN61000-4-3

314

JBM

www.jbmcamp.com

IVA não incluído

PASSA-CABOS / PASSADORES

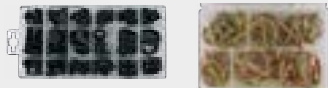

316

CHAVETAS / PARAFUSOS E PORCAS



317

REBITES



319

ANILHAS



320

O'RINGS / VÁLVULAS PARA O AR CONDICIONADO



323

TUBOS TERMO-RETRACTÍLES / CONECTORES DE MANGUEIRA / LUBRIFICADORES



324

ABRAÇADEIRAS DE TUBO / MOLAS / FUSÍVEIS



326

TERMINAIS



327

SORTIMENTO DE CLIPS



328



# CONSUMÍVEIS



SERIE346



## ESTOJO DE CIRCLIPS TIPO "E"

**53348**  
14,00€

0,3 6 24



**150**  
PCS



	M1,5	M3	M5	M6	M9	M12	M15	M19	M22
	15 PCS	15 PCS	20 PCS	25 PCS	25 PCS	20 PCS	10 PCS	10 PCS	10 PCS

## ESTOJO DE PASSA-CABOS DE BORRACHA

**53349**  
14,00€

0,25 6 24



**125**  
PCS



19,5x23 2 PCS	16x24 3 PCS	13x15 3 PCS	11,5x19 4 PCS	10x20 3 PCS	10x12 5 PCS	25 2 PCS	22 3 PCS	19 4 PCS	15 5 PCS
	9,8x11,5 6 PCS	8x14 3 PCS	7,5x13 7 PCS	6x7,5 10 PCS	3,5x6 15 PCS		12 10 PCS	9 20 PCS	7 20 PCS

## ESTOJO DE PASSA-CABOS DE BORRACHA

**53370**  
26,00€

0,3 6 12



**190**  
PCS



	M2	M3	M4	M5	M6	M8	M10
	25 PCS	25 PCS	30 PCS	30 PCS	30 PCS	20 PCS	20 PCS

## ESTOJO DE PASSADORES ELÁSTICOS

**53350**  
14,00€

0,4 6 24



**120**  
PCS



1/16x3/16 4u.	3/32x1-1/4 4u.	3/16x1 5u.	1/4x1-3/4 4u.
1/16x5/16 4u.	1/8x5/8 5u.	3/16x1-1/4 5u.	5/16x3/4 4u.
1/16x3/4 4u.	1/8x1 5u.	7/32x5/8 4u.	5/16x1-1/2 4u.
5/64x1/4 4u.	1/8x1-1/4 5u.	7/32x1-1/4 4u.	5/16x2 4u.
5/64x1/2 4u.	5/32x5/8 4u.	7/32x1-3/4 4u.	3/8x3/4 2u.
5/64x1 4u.	5/32x1 4u.	1/4x5/8 4u.	3/8x1-1/2 2u.
3/32x5/8 4u.	5/32x1-1/2 4u.	1/4x1-1/4 4u.	3/8x2 2u.
3/32x1 4u.	3/16x5/8 5u.		

## CAIXA CAVILHAS DE FENDAS SORTIDAS

**52027**  
14,00€

1,02 6 12 690



**365**  
PCS



1,2x25mm 50 PCS	1,6x32mm 50 PCS	2x40mm 50 PCS	2,5x40mm 50 PCS	3,2x40mm 50 PCS
	3,2x50mm 50 PCS	4x50mm 40 PCS	5x63mm 10 PCS	6,3x63mm 15 PCS

## ESTOJO DE CHAVETAS

**53372**  
26,00€

1,2 6 12



**144**  
PCS



	3x50mm 50 PCS	4x60mm 30 PCS	5x75mm 20 PCS	6x50mm 20 PCS	6x75mm 16 PCS	8x60mm 8 PCS
--	------------------	------------------	------------------	------------------	------------------	-----------------



## ESTOJO DE PASSADORES COM ANILHA

53371  
26,00€

1,45 6 12

50  
PCS



	5x36	6x45	8x45	11x45
	16 PCS	18 PCS	6 PCS	10 PCS

## ESTOJO DE PASSADORES CLEVIS

53363  
28,00€

1,15 6 24

71  
PCS



	8x50	9,5x50	11x63	12,5x50	3,5x44	2,5x42	2,5x58	2x3
	5 PCS	18 PCS	5 PCS	3 PCS	6 PCS	20 PCS	7 PCS	7 PCS

## ESTOJO CLIPS "R"

52044  
19,00€

0,68  
6  
12  
400



150  
PCS

## ESTOJO DE CHAVETAS

53364  
14,00€

0,8 6 24

106  
PCS



	3x3x25	3x3x20	5x5x30	5x5x25	5x5x20	6x6x40	6x6x30
	4 PCS	4 PCS	5 PCS	5 PCS	5 PCS	5 PCS	5 PCS
		6x6x20	8x8x40	8x8x30	10x10x40	10x10x30	12x12x40
		5 PCS	5 PCS	5 PCS	5 PCS	5 PCS	2 PCS

DESMANCHA DISPONÍVEL



REF.	MEDIDA	UDS.	€/u.
10882	2,00x32mm	45	0,25€
10883	1,60x36mm	30	0,25€
10884	1,60x42mm	25	0,25€
10793	2,30x43mm	25	0,25€
10794	3,20x52mm	20	0,40€
10795	3,80x75mm	8	0,60€

## ESTOJO DE PARAFUSOS DE GANCHO

53352  
12,00€

0,6 6 24

151  
PCS

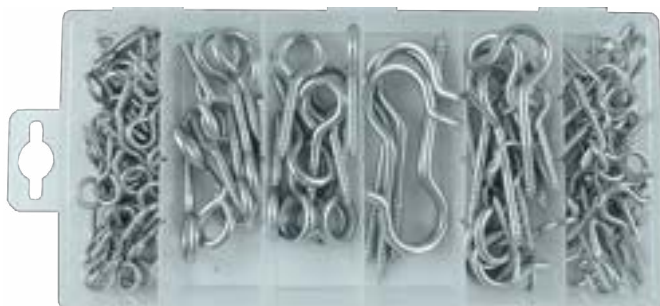

	2,4x25	4x45	4x50
	60 PCS	12 PCS	12 PCS

	2,4x41	4x64	4,2x85
	50 PCS	12 PCS	5 PCS

## ESTOJO DE PARAFUSOS E PORCAS

53351  
12,50€

0,9 6 12

240  
PCS



	4x12	4x20	5x16	5x25	4	5	6	8	10
	10 PCS	10 PCS	10 PCS	10 PCS	20 PCS	20 PCS	20 PCS	10 PCS	10 PCS
	6x20	6x30	8x25	8x40					
	10 PCS	10 PCS	5 PCS	5 PCS					
	10x16	10x40							
	5 PCS	5 PCS							
					4	5	6	8	10
					20 PCS	20 PCS	20 PCS	10 PCS	10 PCS
					4	5	6	8	10
					20 PCS	20 PCS	20 PCS	10 PCS	10 PCS

## ESTOJO DE PARAFUSOS AUTORROSCANTES

53354

0,55 6 24

12,50€



200 PCS



#8x12.5 #8x16 #8x19 #8x25 #10x12.5 #10x16 #10x19 #10x25

30 PCS

30 PCS

30 PCS

30 PCS

20 PCS

20 PCS

20 PCS

20 PCS

## ESTOJO DE PARAFUSOS ALLEN

53362

0,65 6 24

12,00€



106 PCS



4x12 5x12 5x25 10x40 6x25 8x40 10x25 6x12 8x25

25 PCS

25 PCS

20 PCS

3 PCS

10 PCS

5 PCS

3 PCS

10 PCS

5 PCS

## ESTOJO DE PARAFUSOS E PORCAS TIPO U

53366

0,35 6 24

12,50€



170 PCS



#6x5/16 #8x5/8

40 PCS

20 PCS

#6

20 PCS

#6

20 PCS

#8

20 PCS

#10x1/2 1/4x3/4

15 PCS

10 PCS

1/4

10 PCS

#10

15 PCS

## ESTOJO DE PARAFUSOS

53369

0,65 6 24

13,00€



550 PCS



4x1/2" 4x5/8" 6x3/8" 6x1/2" 6x5/8" 6x3/4" 8x1/2"

65 PCS

55 PCS

60 PCS

65 PCS

60 PCS

45 PCS

50 PCS

8x5/8" 8x1" 8x1-1/4" 10x3/4" 10x1" 10x1-1/4"

40 PCS

30 PCS

20 PCS

25 PCS

20 PCS

15 PCS

## CAIXA FÊMEAS AUTOBLOCANTES

52029

1,02 6 24 360

14,00€



228 PCS



M3

50 PCS

M4

50 PCS

M5

40 PCS

M6

30 PCS

M8

20 PCS

M10

15 PCS

M12

10 PCS

M14

8 PCS

M16

5 PCS

## CAIXA DE FÊMEAS

52028

1,05 5 360

11,50€



243 PCS



### DESMANCHA DISPONÍVEL

REF.	MEDIDA	UDS.	€/u.
10805	M3	50	0,10€
10779	M4	50	0,05€
10780	M5	50	0,05€
10781	M6	30	0,05€
10784	M7	20	0,05€
10785	M10	20	0,10€
10786	M12	10	0,15€

REF.	MEDIDA	UDS.	€/u.
10812	M14	8	0,30€
10813	M16	5	0,30€





## ESTOJO DE PORCAS BOLBOLETA

53365  
14,00€

0,75 6 24



150  
PCS



	M4	M5	M6	M8	M10
	40 PCS	40 PCS	25 PCS	25 PCS	20 PCS

## ESTOJO DE REBITES PORCA DE ALUMÍNIO

53361  
20,00€

0,2 6 24



150  
PCS



3x9	4x11	5x13	6x15	8x18	10x21
40 PCS	35 PCS	25 PCS	25 PCS	15 PCS	10 PCS

## CAIXA REBITES FÊMEA

52703  
19,00€

0,79 6 24 800



235  
PCS



M3	M4	M5	M6	M8	M10	M12
50 PCS	50 PCS	50 PCS	40 PCS	20 PCS	15 PCS	10 PCS

## ESTOJO DE REBITES PORCA

53360  
16,00€

0,45 6 24



150  
PCS



3x9	4x11	5x13	6x15	8x18	10x21
40 PCS	35 PCS	25 PCS	25 PCS	15 PCS	10 PCS

DESMANCHA DISPONÍVEL

REF.	MEDIDA	UDS.	€/u.
13235	M3	200	0,15€
13236	M4	200	0,15€
13237	M5	200	0,15€
13238	M6	100	0,20€
13239	M8	50	0,20€
13240	M10	40	0,40€
13241	M12	20	0,55€



## CAIXA DE REBITES PLÁSTICO

52711  
27,50€

0,44 48 384



150  
PCS

MÁQUINA DE REBITES DE AR DISPONÍVEL EM PÁG.48 E 127 (REF. 52575)



DESMANCHA DISPONÍVEL



REF.	MEDIDA	UDS.	€/u.
13674	6x19,3mm	25	0,50€
13675	6x17,8mm	25	0,50€
13676	6x25,5mm	25	0,50€
13677	6x24,5mm	25	0,50€
13678	6x24mm	25	0,50€



6x19.3mm	6x17.9mm	6x25.5mm
25 PCS	25 PCS	25 PCS
6x24.5mm	6x24mm	6x24mm
25 PCS	25 PCS	25 PCS

## CAIXA DE REBITES

52043  
16,50€

0,98 6 12 480

300  
PCS



4.8x16.9mm	4.8x24.8mm	
40 PCS	35 PCS	
3.2x9.7mm	4.8x12.7mm	4.8x20mm
25 PCS	25 PCS	15 PCS



DESMANCHA DISPONÍVEL

REF.	MEDIDA	UDS.	€/u.
10877	4,8x16,90mm	0,04 5	500 2.000 0,25€
10878	4,8x24,80mm	0,01 10	500 1.800 0,30€
10879	3,2x9,70mm	0,02 10	500 4.000 0,20€
10880	4,8x12,70mm	0,03 10	500 2.000 0,20€
10881	4,8x20,00mm	0,04 10	500 1.480 0,25€





## CAIXA SURTIDA DE PARAFUSOS, FÊMEAS E ANILHAS

51804

5,68 5 120

57,50€



DESMANCHA DISPONÍVEL

828  
PCS

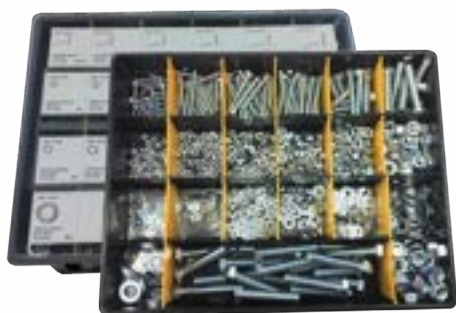

REF.	MEDIDA	UDS.	€/u.
10772	Tornillo Zincado DIN 933 8.8 M4x25	0,01 25	0,05€
10773	Tornillo Zincado DIN 933 8.8 M5x50	0,01 25	0,10€
10774	Tornillo Zincado DIN 933 8.8 M6x50	0,01 25	0,10€
10775	Tornillo Zincado DIN 933 8.8 M7x50	0,01 15	0,15€
10776	Tornillo Zincado DIN 933 8.8 M8x50	0,01 15	0,20€
10777	Tornillo Zincado DIN 933 8.8 M10x50	0,04 12	0,20€
10778	Tornillo Zincado DIN 933 8.8 M12x60	0,05 20	0,35€
10779	Tuerca Zincada DIN 934 M4	0,02 50	0,05€
10780	Tuerca Zincada DIN 934 M5	0,01 50	0,05€
10781	Tuerca Zincada DIN 934 M6	0,01 50	0,05€
10782	Tuerca Zincada DIN 934 M7	0,01 50	0,05€
10784	Tuerca Zincada DIN 934 M8	0,01 50	0,05€
10785	Tuerca Zincada DIN 934 M10	0,01 50	0,10€
10786	Tuerca Zincada DIN 934 M12	0,01 40	0,15€
10787	Arandela Zincada DIN 125 M4	0,01 50	0,05€

REF.	MEDIDA	UDS.	€/u.
10788	Arandela Zincada DIN 125 M5	0,01 50	0,05€
10789	Arandela Zincada DIN 125 M6	0,01 50	0,05€
10790	Arandela Zincada DIN 125 M7	0,01 50	0,05€
10791	Arandela Zincada DIN 125 M8	0,01 50	0,05€
10792	Arandela Zincada DIN 125 M10	0,01 50	0,05€
10783	Arandela Zincada DIN 125 M12	0,01 50	0,05€
50959	Caja 19 compartimentos	0,7 1	12,00€



## ESTOJO DE ANILHAS DE FERRO GALVANIZADO 475 PEÇAS

52158

3,45 5 90

38,50€



475  
PCS

5x20x1,5mm 50 PCS	6x20x1,5mm 50 PCS	7x20x1,5mm 50 PCS	8x20x1,5mm 50 PCS
8x20x1,75mm 50 PCS	10x30x2,5mm 25 PCS	6x30x2mm 25 PCS	7x30x2mm 25 PCS
8x30x2mm 25 PCS	4x11x0,98mm 50 PCS	14x40x3mm 25 PCS	4x20x1,5mm 50 PCS



## ESTOJO DE ANILHAS DE FERRO SOBRE-MEDIDAS

53377

1,6 6 12

20,00€



20x6x1.5 20 PCS	20x8x1.5 20 PCS	20x10x1.5 20 PCS	25x6x1.5 20 PCS	25x8x1.5 20 PCS	25x10x1.5 20 PCS
32x2x1.5 20 PCS	32x4x1.5 20 PCS	32x6x1.5 20 PCS	32x8x1.5 20 PCS	32x10x1.5 20 PCS	32x10x1.5 20 PCS

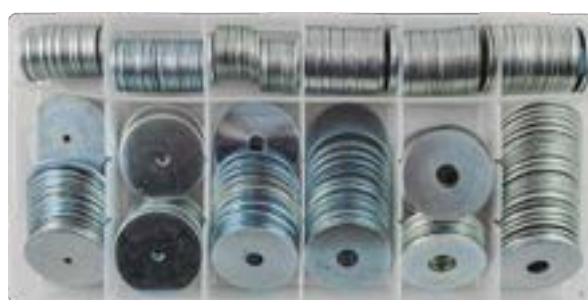

240  
PCS



## ESTOJO DE ANILHAS 18 ALUMÍNIO

52031

0,576 24 384

40,00€



3x7x1,5mm 50 PCS	4x8x1,5mm 50 PCS	5x6x1,5mm 50 PCS	16x22x1,5mm 50 PCS	14x22x1,5mm 50 PCS	14x20x1,5mm 50 PCS
6x10x1,5mm 50 PCS	6x11x1,5mm 50 PCS	7x11x1,5mm 50 PCS	7x12x1,5mm 50 PCS	8x12x1,5mm 50 PCS	8x14x1,5mm 50 PCS
9x12x1,5mm 50 PCS	10x14x1,5mm 50 PCS	11x16x1,5mm 50 PCS	11x17x1,5mm 50 PCS	12x16x1,5mm 50 PCS	12x16x1,5mm 50 PCS



900  
PCS

## ESTOJO DE ANILHAS DE PRESSÃO PRETAS

52032  
28,00€

1,68 5 870

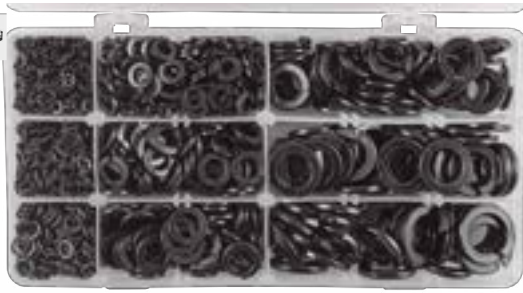

1.735  
PCS

3mm 600 PCS	4mm 400 PCS	5mm 220 PCS	6mm 220 PCS	8mm 110 PCS
10mm 65 PCS	12mm 50 PCS	14mm 40 PCS	16mm 30 PCS	

## ESTOJO DE ANILHAS DE COBRE PARA INJETORES

53229  
35,00€

0,4 5 20

150  
PCS



13.8x7.3x1.4mm 10 PCS	15.0x7.0x2.0mm 10 PCS	15.0x7.5x2.0mm 10 PCS	15.5x7.5x2.0mm 10 PCS	16.0x7.5x2.0mm 10 PCS
14.6x7.5x1.3mm 10 PCS	15.0x7.5x1.0mm 10 PCS	15.0x7.5x2.5mm 10 PCS	16.0x7.5x1.5mm 10 PCS	16.4x7.5x2.0mm 10 PCS
14.6x7.5x3.0mm 10 PCS	15.0x7.5x1.5mm 10 PCS	15.0x7.5x3.0mm 10 PCS	16.0x7.5x1.7mm 10 PCS	20.0x9.4x0.9mm 10 PCS

53229



DESMANCHA  
DISPONÍVEL

53340  
74,00€

0,9 10 1.050

375  
PCS



13.8x7.3x1.4mm 25 PCS	15.0x7.0x2.0mm 25 PCS	15.0x7.5x2.0mm 25 PCS	15.5x7.5x2.0mm 25 PCS	16.0x7.5x2.0mm 25 PCS
14.6x7.5x1.3mm 25 PCS	15.0x7.5x1.0mm 25 PCS	15.0x7.5x2.5mm 25 PCS	16.0x7.5x1.5mm 25 PCS	16.4x7.5x2.0mm 25 PCS
14.6x7.5x3.0mm 25 PCS	15.0x7.5x1.5mm 25 PCS	15.0x7.5x3.0mm 25 PCS	16.0x7.5x1.7mm 25 PCS	20.0x9.4x0.9mm 25 PCS

53340



DESMANCHA  
DISPONÍVEL

DESMANCHA  
DISPONÍVEL

13819 50 6,50€ 13.8 x 7.3 x 1.4 mm	13822 50 11,00€ 15.0 x 7.0 x 2.0 mm	13825 50 11,50€ 15.0 x 7.5 x 2.0 mm	13828 50 11,50€ 15.5 x 7.5 x 2.0 mm	13831 50 12,55€ 16.0 x 7.5 x 2.0 mm
13820 50 7,00€ 14.6 x 7.5 x 1.3 mm	13823 50 6,00€ 15.0 x 7.5 x 1.0 mm	13826 50 13,00€ 15.0 x 7.5 x 2.5 mm	13829 50 10,50€ 16.0 x 7.5 x 1.5 mm	13832 50 13,00€ 16.4 x 7.5 x 2.0 mm
13821 50 14,00€ 14.6 x 7.5 x 3.0 mm	13824 50 8,00€ 15.0 x 7.5 x 1.5 mm	13827 50 15,00€ 15.0 x 7.5 x 3.0 mm	13830 50 10,50€ 16.0 x 7.5 x 1.7 mm	13833 50 9,00€ 20.0 x 9.4 x 0.9 mm

## ESTOJO DE ANILHAS 18 COBRE

52030  
84,50€

1,21 6 12 384

900  
PCS



DESMANCHA DISPONÍVEL

REF.	MEDIDA	€/u.
10823	3x7x1,5mm 0,01 50	0,20€
10824	4x8x1,5mm 0,01 50	0,20€
10825	5x6x1,5mm 0,01 50	0,20€
10826	16x22x1,5mm 0,01 50	0,40€
10827	14x22x1,5mm 0,01 50	0,60€
10828	14x20x1,5mm 0,01 50	0,45€
10829	6x10x1,5mm 0,01 50	0,20€
10830	6x11x1,5mm 0,01 50	0,20€
10831	7x11x1,5mm 0,01 50	0,20€
10832	7x12x1,5mm 0,01 50	0,20€
10833	8x12x1,5mm 0,01 50	0,20€
10834	8x14x1,5mm 0,01 50	0,25€
10835	9x12x1,5mm 0,01 50	0,25€
10836	10x14x1,5mm 0,01 50	0,30€
10837	11x16x1,5mm 0,01 50	0,30€
10838	11x17x1,5mm 0,01 50	0,30€
10839	12x16x1,5mm 0,01 50	0,40€
10840	12x18x1,5mm 0,01 50	0,35€





# ESTOJO DE ANILHAS DE COBRE PARA INJETORES 551 PCS

53464

139,00€

1,7 5 90



Ø15.0X8.0X1.5 30 PCS	Ø15.0X7.0X1.5 12 PCS	Ø13.0X7.5X2.5 30 PCS	Ø15.0X7.5X1.5 30 PCS	Ø15.45X8.0X2.0 30 PCS
Ø15.45X8.0X2.0 30 PCS	Ø13.5X10X2.0 12 PCS	Ø15.5X7.5X2.5 30 PCS	Ø15.5X7.5X1.5 12 PCS	Ø15.0X7.5X3.0 30 PCS
Ø13.0X7.0X1.5 12 PCS	Ø13.5X7.5X1.5 30 PCS	Ø15.0X7.5X1.5 12 PCS	Ø15.5X7.5X1 12 PCS	Ø16.5X7.5X2 30 PCS
Ø13.7X7.3X3 12 PCS	Ø13.7X7.3X2 12 PCS	Ø10X6.0X1.0 50 PCS	Ø15.8X7.5X3.0 30 PCS	Ø8X5.8X1 30 PCS
"T" 20 PCS	"L" 30 PCS	retenção springs 25 PCS		



30

## DESMANCHA DISPONÍVEL

UNIVERSAL Ø15.0X8.0X1.5 13945 4,70€	MERCEDES Ø15.0X7.0X1.5 13946 6,05€	RENAULT Ø13.0X7.5X2.5 13947 5,50€
IVECO, FORD, BMW, MAN Ø15.0X7.5X1.5 13948 4,70€	UNIVERSAL Ø15.45X8.0X2.0 13949 6,50€	UNIVERSAL Ø15.45X8.0X2.0 13950 7,30€
MAZDA Ø13.5X10X2.0 13951 5,15€	FORD Ø15.5X7.5X2.5 13952 9,50€	LAND ROVER Ø15.5X7.5X1.5 13953 7,00€
RENAULT Ø15.0X7.5X3.0 13954 11,00€	DEUTZ Ø13.0X7.0X1.5 13955 4,70€	FORD Ø13.5X7.5X1.5 13956 4,10€
FIAT Ø15.0X7.5X1.5 13957 6,40€	MAN ROVER Ø15.5X7.5X1 13958 5,15€	MERCEDES Ø16.5X7.5X2 13959 8,65€
KIA Ø13.7X7.3X3 13960 9,00€	KIA Ø13.7X7.3X2 13961 8,60€	AÇO Ø10X6.0X1.0 13962 1,80€
LATÃO Ø15.8X7.5X3.0 13963 11,50€	CONECTORES DE MANGUEIRA EM "T" 13964 13,00€	ALUMÍNIO Ø8X5.8X1 13965 1,50€
CONECTORES DE MANGUEIRA EM "L" 13966 12,90€	RETENÇÃO SPRINGS 13967 4,65€	

551 PCS



# ANILHAS PARA BUJÃO DE CÁRTER FERRO-BORRACHA

Ø 10MM / 0,02KG 52719 0,19€/u.	0,04 100 5.000
Ø 12MM / 0,03KG 51843 0,19€/u.	0,01 100 5.000

BORRACHA Ø 13MM / 0,01KG 51554 0,28€/u.	0,01 100 5.000
Ø 14MM / 0,01KG 51546 0,19€/u.	0,01 100 5.000

Ø 16MM / 0,01KG 51799 0,20€/u.	0,01 100 2.500
--------------------------------------	----------------

# CAIXA DE ANILHAS DE COBRE PARA BUJÕES DE CÁRTER

52163

86,00€

0,65  
6  
12  
400



DESMANCHA DISPONÍVEL



## ANILHAS PARA BUJÕES DE CÁRTER

REF.	MEDIDA	€ / u.
51538	Ø10mm / 0,01kg	0,15€
51539	Ø12mm / 0,01kg	0,15€
51540	Ø14mm / 0,01kg	0,15€
51541	Ø16mm / 0,01kg	0,25€
51542	Ø18mm / 0,01kg	0,20€
51543	Ø20mm / 0,01kg	0,25€
51544	Ø22mm / 0,02kg	0,25€
51545	Ø26mm / 0,02kg	0,30€

Ø10MM 100 PCS	Ø12MM 100 PCS	Ø14MM 100 PCS
Ø16MM 100 PCS	Ø18MM 100 PCS	Ø20MM 25 PCS

COMPRESSÍVEL





## ESTOJO DE ANILHAS DE COBRE

53353  
18,00€

0,2 6 24

110  
PCS



	M6	M8	M10	M12	M14	M16
	30 PCS	25 PCS	20 PCS	15 PCS	10 PCS	10 PCS

## ESTOJO DE ANILHAS DENTADAS INTERIOR

53373  
14,50€

0,25 6 24

260  
PCS



	M3x10	M4x12	M5x14	M6x14	M8x18	M10x20	M12x25
	30 PCS	30 PCS	40 PCS	50 PCS	50 PCS	40 PCS	20 PCS

## ESTOJO DE ANILHAS SEGER EXTERIORES

53383  
11,50€

0,2 6 24

300  
PCS



	M4	M6	M8	M10	M12
	50 PCS	40 PCS	45 PCS	30 PCS	30 PCS
	M14	M16	M18	M20	M22
	25 PCS	25 PCS	25 PCS	15 PCS	15 PCS

## ESTOJO DE ANILHAS SEGER INTERIORES

53382  
11,00€

0,15 6 24

300  
PCS

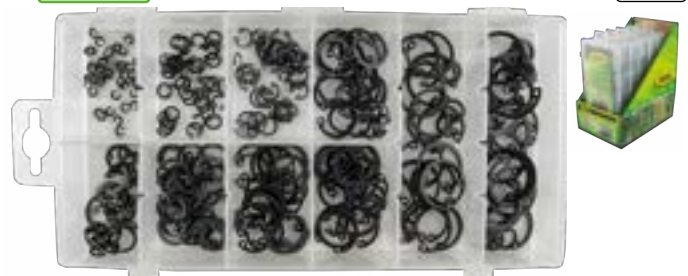

	M4	M6	M8	M10	M12
	50 PCS	40 PCS	45 PCS	30 PCS	30 PCS
	M14	M16	M18	M20	M22
	25 PCS	25 PCS	25 PCS	15 PCS	15 PCS

## SURTIDO DE ANILHAS DE FIBRA

53381  
14,50€

0,25  
6  
12



	10x5.5x1	16x10x1	19x12x1	22x16x1	22.5x14x1	32x22x1
	160 PCS	80 PCS	40 PCS	30 PCS	20 PCS	20 PCS
	12x6.5x1	16x8x1	20x12.5x1	27x20x1	25.4x17.5x1	32x24x1
	100 PCS	60 PCS	40 PCS	20 PCS	15 PCS	15 PCS

600  
PCS

## CONJUNTO DE VÁLVULAS PARA O AR CONDICIONADO

53599  
29,00€

0,15 10 100

134  
PCS



	R12		R134A
5mm	L: 19mm	6mm	L: 19mm
	R12		R134A
5mm	L: 19mm	6mm	L: 22mm
	R12		R134A
5mm	L: 19mm	6mm	L: 26.5mm
		9mm	L: 22mm



### DESMANCHA DISPONÍVEL

REF.	MEDIDA	€ / u.
14594	5x19mm R12 (VERDE)	0,01 10 2,00€
14595	5x19mm	0,01 10 1,50€
14596	5x19mm R12	0,01 10 2,00€
14597	6x19mm	0,01 10 7,60€
14598	6x26.5mm	0,01 10 17,80€
14599	7x20mm R134A	0,01 10 4,50€
14600	6x22mm	0,01 10 9,50€
14601	8x22mm	0,01 10 11,00€
14602	9x22mm	0,01 10 11,00€

# CAIXA DE O'RINGS

MÉTRICAS - 386 UNIDADES

TAPA DEL ESTUCHE	Posição no estôjo	006	007	008	009	010	011
	Larg. borracha (mm)	2	2	2	2	2	2
	Ø interior (mm)	3	4	5	6	7	8
	Quantidade	16	16	16	16	16	16

TAPA DEL ESTUCHE	Posição no estôjo	113	112	111	110	012
	Larg. borracha (mm)	2.5	2.5	2.5	2.5	2
	Ø interior (mm)	14	12	11	10	10
	Quantidade	13	13	13	13	17

TAPA DEL ESTUCHE	Posição no estôjo	114	115	116	210
	Larg. borracha (mm)	2.5	2.5	2.5	3
	Ø interior (mm)	16	17	19	19
	Quantidade	13	13	13	10

BAZA TRUSEI	Posição no estôjo	222	325	326	327
	Larg. borracha (mm)	3	4	4	4
	Ø interior (mm)	38	38	41	44
	Quantidade	12	10	9	9

BAZA TRUSEI	Posição no estôjo	221	220	219	218	217
	Larg. borracha (mm)	3	3	3	3	3
	Ø interior (mm)	36	35	33	32	30
	Quantidade	12	12	12	12	12

BAZA TRUSEI	Posição no estôjo	211	212	213	214	215	216
	Larg. borracha (mm)	3	3	3	3	3	3
	Ø interior (mm)	20	22	24	25	27	28
	Quantidade	12	12	12	12	12	12

**50651**

16,50€

- 0,58
- 5
- 20
- 400

QUALIDADE HNBR



**386**  
PCS

POLEGADAS - 386 UNIDADES

TAPA DEL ESTUCHE	Posição no estôjo	006	007	008	009	010	011
	Larg. borracha	1/16	1/16	1/16	1/16	1/16	1/16
	Ø interior	1/8	5/32	3/16	7/32	1/4	5/16
	Quantidade	20	20	20	20	20	20

TAPA DEL ESTUCHE	Posição no estôjo	113	112	111	110	012
	Larg. borracha	3/32	3/32	3/32	3/32	1/16
	Ø interior	9/16	1/2	7/16	3/8	3/8
	Quantidade	13	13	13	13	13

TAPA DEL ESTUCHE	Posição no estôjo	114	115	116	210
	Larg. borracha	3/32	3/32	3/32	1/8
	Ø interior	5/8	11/16	3/4	3/4
	Quantidade	13	13	13	10

BAZA TRUSEI	Posição no estôjo	222	325	326	327
	Larg. borracha	1/8	3/16	3/16	3/16
	Ø interior	11/2	11/2	15/8	13/4
	Quantidade	10	7	7	7

BAZA TRUSEI	Posição no estôjo	221	220	219	218	217
	Larg. borracha	1/8	1/8	1/8	1/8	1/8
	Ø interior	17/16	13/8	15/16	11/4	13/16
	Quantidade	10	10	10	10	10

BAZA TRUSEI	Posição no estôjo	211	212	213	214	215	216
	Larg. borracha	1/8	1/8	1/8	1/8	1/8	1/8
	Ø interior	13/16	7/8	15/16	1	11/16	11/8
	Quantidade	10	10	10	10	10	10

**50652**

16,50€

- 0,66
- 5
- 20
- 400

QUALIDADE HNBR



# CAIXA DE O'RINGS PARA AACC

**50807**

35,00€

- 0,16
- 6
- 24
- 750



5.29X1.78MM 20 PCS	6.07x1.78mm 20 PCS	6.8x1.9mm 20 PCS	<b>270</b> PCS		
7.65x1.78mm 20 PCS	7.80x1.90mm 20 PCS	8.0X2.0MM 20 PCS	8.80X1.90MM 20 PCS	10.82X1.78MM 15 PCS	
10.77X2.62MM 15 PCS	11.0X2.0MM 15 PCS	12.0X2.0MM 15 PCS	13.9x1.80mm 10 PCS	13.95x2.62mm 10 PCS	
14.0X2.0MM 10 PCS	15.0X2.0MM 10 PCS	17.0X2.00MM 10 PCS	17.17x1.778mm 10 PCS	17.04x3.53mm 10 PCS	

# ESTOJO DE TUBOS TERMO-RETRACTILES

**53374**

10,00€

- 0,15
- 6
- 24

**53376**

10,50€

- 0,15
- 6
- 24

**53376**



**127**  
PCS



**53374**

MAÇARICO

**51920**  
18,00€

- 0,12
- 10
- 100
- 400



EM PÁG. 206

M2x40 30 PCS	M2.5x40 25 PCS	M3.5x40 20 PCS	M5x40 20 PCS	M7x80 16 PCS	M10x80 8 PCS	M13x85 8 PCS
-----------------	-------------------	-------------------	-----------------	-----------------	-----------------	-----------------



## CONJUNTO DE MANGAS DE SOLDA TERMOENCOLHÍVEIS 100PCS

**53992**  
16,00€

0,10 6 84 1.512

- Fornece conexão rápida e fácil de cabos, solda e vedação, colocando os cabos numa manga de solda antes do tratamento térmico subsequente.  
- Material: polietileno.  
- Material do anel de solda: estanho.

**100**  
PCS



Ø1.7mm 0.25-0.34mm <sup>2</sup> 26-24 AWG	Ø2.7mm 0.5-1.0mm <sup>2</sup> 22-18 AWG	Ø4.7mm 1.5-2.5mm <sup>2</sup> 16-14 AWG	Ø6.0mm 4.0-6.0mm <sup>2</sup> 12-10 AWG
<b>25</b> PCS	<b>35</b> PCS	<b>30</b> PCS	<b>10</b> PCS

## ESTOJO DE CONECTORES DE MANGUEIRA

**53910**  
17,50€

0,23  
6  
24

RETO			REDUTOR	
	4.8x4.8 <b>10</b> PCS	6.3x6.3 <b>8</b> PCS		3.17x3.17 <b>30</b> PCS
	7.9x7.9 <b>6</b> PCS	9.5x9.5 <b>6</b> PCS		9.5x6.3 <b>6</b> PCS
	9.5x9.5 <b>6</b> PCS			6.3x4.8 <b>10</b> PCS
TUBO EM T				
	3.9x3.9x3.9 <b>8</b> PCS	4.8x4.8x4.8 <b>8</b> PCS		3.17x3.17x3.17 <b>12</b> PCS
	6.3x6.3x6.3 <b>6</b> PCS	9.5x9.5x9.5 <b>3</b> PCS		



**113**  
PCS

**53434**  
18,00€

0,15  
6  
24  
720

	4x28.7 <b>10</b> PCS		3.9x30.8 <b>5</b> PCS		10.4x44.4 <b>10</b> PCS		5.6x47.1 <b>5</b> PCS
	7.9x38 <b>10</b> PCS		4.7x38.9 <b>5</b> PCS		5.2x33.9 <b>10</b> PCS		7x30 <b>10</b> PCS



**65**  
PCS

## ESTOJO DE BICOS PARA ENGRASSAR

**52033**  
37,50€

0,89 6 24 720



DESMANCHA DISPONÍVEL



ÂNGULO RECTO

REF.	MEDIDA			€/u.
10868	6x1	0,01	10	0,30€
10869	8x1	0,01	15	0,30€
10870	10x1	0,01	10	0,45€

ÂNGULO 90°

REF.	MEDIDA			€/u.
10874	6x1	0,01	20	0,30€
10875	8x1	0,01	15	0,40€
10876	10x1	0,01	10	0,45€

ÂNGULO 45°

REF.	MEDIDA			€/u.
10871	6x1	0,01	20	0,30€
10872	8x1	0,01	15	0,40€
10873	10x1	0,01	10	0,45€

**135**  
PCS

## SURTIDO DE LUBRIFICADORES

**53359**  
14,50€

0,5 6 24

	6x1 <b>5</b> PCS		6x1 <b>60</b> PCS		6x1 <b>5</b> PCS
	8x1.25 <b>5</b> PCS		8x1.25 <b>10</b> PCS		8x1.25 <b>5</b> PCS
	10x1.5 <b>5</b> PCS		10x1.5 <b>10</b> PCS		10x1.5 <b>5</b> PCS
ÂNGULO 90°		ÂNGULO RECTO		ÂNGULO 45°	



**110**  
PCS



## SURTIDO DE ABRAÇADEIRAS DE TUBO

**53378** 0,45 6 24  
13,00€

1"	1-1/4"	1-3/4"	2"
4 PCS	2 PCS	2 PCS	4 PCS
2-1/2"	3"	3-1/2"	4"
2 PCS	2 PCS	2 PCS	2 PCS



**20**  
PCS



## ESTOJO DE MOLAS

**53358** 0,25 6 24  
11,50€



5/16x1-3/4 5 PCS	9/32x1/2 5 PCS	1/4x13/32 5 PCS	7/32x11/16 5 PCS	7/32x1-1/2 5 PCS
3/8x5/8 5 PCS	3/8x3/4 5 PCS	23/64x1-3/8 5 PCS	9/32x3/4 5 PCS	
13/64x13/16 10 PCS	7/32x1 10 PCS	1/4x7/8 10 PCS	5/16x1-1/8 8 PCS	5/16x1-1/4 10 PCS
3/16x1-3/4 8 PCS	9/32x1-1/2 10 PCS	11/32x1-7/16 10 PCS	11/32x1-27/32 12 PCS	9/32x2 12 PCS
			5/32x3-1/8 12 PCS	

**200**  
PCS



## KIT DE 2 PINÇAS DE CROCODÍLO

**53357** 0,01 6 24  
7,00€



**2**  
PCS

**30**  
AMP



## ESTOJO DE FUSÍVEIS MINI

**53355**  
11,50€

0,15
6
24
672



**120**  
PCS



5A	10A	15A	20A	25A	30A
20 PCS	20 PCS	20 PCS	20 PCS	20 PCS	20 PCS

## ESTOJO DE FUSÍVEIS

**53356** 0,25 6 24  
11,50€



15A
20 PCS

5A	10A
20 PCS	20 PCS

20A	25A	30A
20 PCS	20 PCS	20 PCS

### DESMANCHA DISPO-NÍVEL

REF.	MEDIDA	€./u.
10915	5A 0,01 20	0,25€
10917	10A 0,01 20	0,30€
10918	15A 0,01 20	0,30€
10919	20A 0,01 20	0,30€
10920	25A 0,01 20	0,25€
10921	30A 0,01 20	0,30€



**120**  
PCS



## ESTOJO DE FUSÍVEIS

**53367**  
9,50€

0,10
6
24
1.608



**48**  
PCS



5A	10A	15A	20A	25A	30A
8 PCS	8 PCS	8 PCS	8 PCS	8 PCS	8 PCS

## ESTOJO DE FUSÍVEIS

**53368**  
9,00€

0,10
6
24

Mini fusíveis



**50**  
PCS



5A	10A	15A	20A	25A	30A
8 PCS	8 PCS	8 PCS	8 PCS	8 PCS	10 PCS

## ESTOJO DE FUSÍVEIS MINI

53380

0,17 6 24

11,50€



	5A	10A	15A
	20 PCS	20 PCS	20 PCS
	20A	25A	30A
	20 PCS	20 PCS	20 PCS



120 PCS



## ESTOJO DE FUSÍVEIS

52054

0,35 6 24 750

15,50€



DESMANCHA DISPONÍVEL

252 PCS



MINI XXA

REF.	COLOR	POTÊNCIA				€/u.
10905		3A	0,01	20	-	0,25€
10906		4A	0,01	20	-	0,25€
10907		5A	0,01	20	-	0,25€



STANDARD XXA

REF.	COLOR	POTÊNCIA				€/u.
10914		4A	0,01	20	-	0,25€
10915		5A	0,01	20	-	0,25€
12954		3A	0,01	20	-	0,25€

3A	4A	5A	7,5A	10A	15A	20A	25A	30A
20 PCS	20 PCS	20 PCS	20 PCS	20 PCS	20 PCS	20 PCS	20 PCS	20 PCS
3A	4A	5A	7,5A	10A	15A	20A	25A	30A
8 PCS	8 PCS	8 PCS	8 PCS	8 PCS	8 PCS	8 PCS	8 PCS	8 PCS



MINI XXA

REF.	COLOR	POTÊNCIA				€/u.
10908		7,5A	0,01	20	-	0,30€
10909		10A	0,01	20	1000	0,30€
10910		15A	0,01	20	-	0,30€



STANDARD XXA

REF.	COLOR	POTÊNCIA				€/u.
10916		7,5A	0,01	20	-	0,30€
10917		10A	0,01	20	4000	0,30€
10918		15A	0,01	20	3500	0,30€



MINI XXA

REF.	COLOR	POTÊNCIA				€/u.
10911		20A	0,01	20	1000	0,30€
10912		25A	0,01	20	-	0,25€
10913		30A	0,01	20	-	0,30€



STANDARD XXA

REF.	COLOR	POTÊNCIA				€/u.
10919		20A	0,01	20	2000	0,30€
10920		25A	0,01	20	2000	0,25€
10921		30A	0,01	20	2000	0,30€

## ESTOJO DE TERMINAIS 635 PIEZAS

52053

0,6 6 24 800

38,50€



DESMANCHA DISPONÍVEL



635 PCS



REF.	COLOR	POTÊNCIA				€/u.
10885		RV1.25-4S	0,01	20	-	0,20€
10886		RV2-4S	0,01	20	-	0,20€
10887		RV2-6S	0,01	20	-	0,25€
10888		RV5.5-6S	0,01	20	-	0,30€
10889		RV5.5-5S	0,01	20	-	0,30€
10893		RV2-5S	0,01	20	-	0,25€



REF.	COLOR	POTÊNCIA				€/u.
10894		SV1-4S	0,01	20	-	0,20€
10895		SV2-4S	0,01	20	-	0,20€



REF.	COLOR	POTÊNCIA				€/u.
10890		BV5.5	0,01	20	-	0,35€
10891		BV2	0,01	20	-	0,25€
10892		BV1.25	0,01	20	-	0,30€



REF.	COLOR	POTÊNCIA				€/u.
10896		FDD1.25-250	0,01	20	2000	0,30€
10898		FDD2-250	0,01	20	1500	0,30€
10900		FDD5.5-250	0,01	20	2000	0,30€



REF.	COLOR	POTÊNCIA				€/u.
10902		FDNF 1.25-250	0,01	20	2000	0,30€



REF.	COLOR	POTÊNCIA				€/u.
10897		MDD1.25-250	0,01	20	-	0,30€
10899		MDD2-250	0,01	20	3000	0,30€
10901		MDD5.5-250	0,01	20	-	0,25€

RV1.25-4S	RV2-4S	RV2-6S	RV5.5-6S	RV5.5-5S	BV5.5
50 PCS	50 PCS	30 PCS	20 PCS	20 PCS	15 PCS
BV2	BV1.25	RV2-5S	SV1-4S	SV2-4S	FDD1.25-250
25 PCS	30 PCS	40 PCS	50 PCS	40 PCS	45 PCS
MDD1.25-250	FDD2-250	MDD2-250	FDD5.5-250	MDD5.5-250	FDNF1.25-250
50 PCS	40 PCS	50 PCS	25 PCS	30 PCS	25 PCS

ALICATE PARA TERMINAIS

VEJA A PAG. 59





# SORTIMENTO DE CLIPS

UNIDADES  
NO CASO



UNIDADES POR  
SACO DE PEÇAS  
SOBRESSALENTES

SACOS POR SUBCAIXA / CAIXA



DESMANCHA  
DISPONÍVEL

## PARA MAZDA

**52896**  
24,00€

**190**  
PCS



**13104** 8 8  
1,90€

OE 2042301



**13105** 15 15  
2,50€

OE 999100402



**13106** 8 8  
2,00€

OE B0016830200



**13107** 8 10  
2,15€

OE N30413356A



**13108** 20 20  
1,90€

OE 992640543A



**13109** 30 30  
2,90€

OE 99249051B

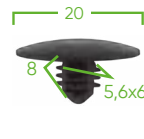

**13110** 15 15  
1,85€

OE 6508197AA



**13111** 10 10  
1,20€

OE B1016825200



**13112** 6 6  
1,65€

OE B09251833



**13113** 20 20  
2,20€

OE 992640543A

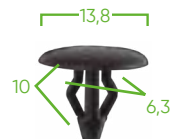

**13114** 20 20  
2,20€

OE B45556741

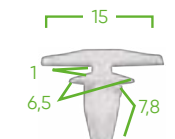

**13115** 30 30  
2,50€

OE G03158762

## PARA TOYOTA / LEXUS

**52886**  
18,00€

**89**  
PCS

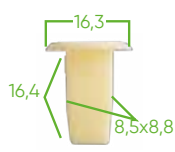

**13002** 8 8  
1,45€

OE 9018906001



**13003** 5 4  
1,70€

OE 9046707138

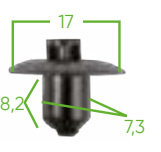

**13004** 10 10  
1,85€

OE 9046707117

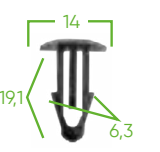

**13005** 10 10  
1,25€

OE 9046709138

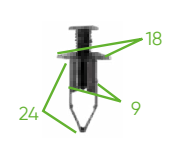

**13006** 5 5  
1,40€

OE 9046709101

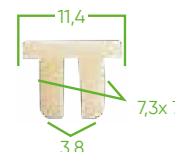

**13007** 10 10  
1,30€

OE 75521611000

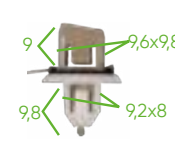

**13008** 8 8  
2,25€

OE 7503933060

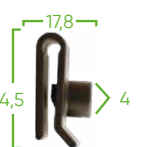

**13009** 4 4  
1,65€

OE 9017905060

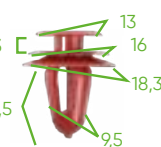

**13010** 8 8  
1,75€

OE 677711250

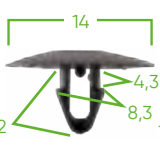

**13011** 5 5  
1,15€

OE 9046708124

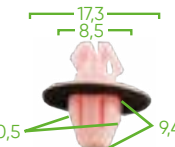

**13012** 8 8  
1,80€

OE 7539533030



**13013** 8 8  
1,75€

OE 9046711063

## PARA HONDA

**52887**  
22,00€

**150**  
PCS

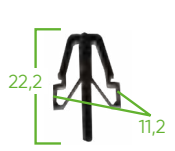

**13014** 12 12  
1,45€

OE 75103SJ4003

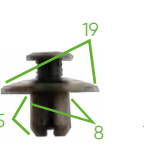

**13015** 5 5  
1,20€

OE 90675SB003

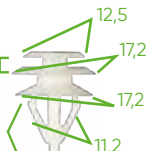

**13016** 6 6  
1,15€

OE 91566SP0003

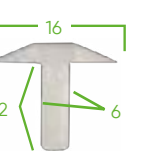

**13017** 25 25  
2,60€

OE 91513SE003

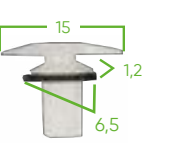

**13018** 25 25  
1,45€

OE 91530ST5003

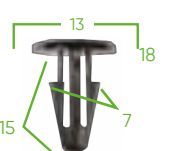

**13019** 15 15  
1,75€

OE 90687SA50030



**13020** 8 8  
1,70€

OE 91620SR2003

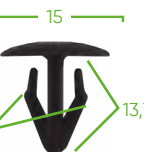

**13021** 8 8  
1,30€

OE 38529689A6300

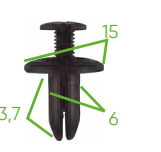

**13022** 10 10  
2,10€

OE 90683SA5003

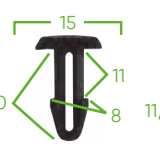

**13023** 10 10  
1,50€

OE 90672671003

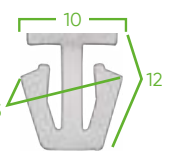

**13024** 18 18  
2,45€

OE 91534SEO000

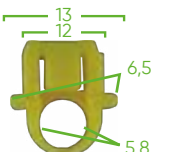

**13025** 8 8  
1,50€

OE 34355SD2003



## PARA PEUGEOT / CITROËN

52899

34,00€

345  
PCS

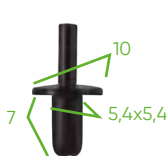

**13128** 50 50  
1,85€

OE 947098



**13129** 20 20  
2,00€

OE 856535

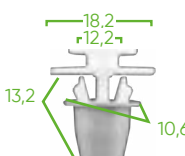

**13130** 20 20  
3,75€

OE 6991WK

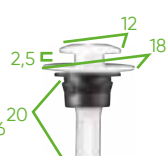

**13131** 20 20  
3,45€

OE 694143

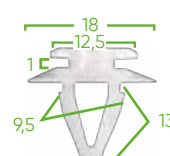

**13132** 25 25  
2,65€

OE 694143

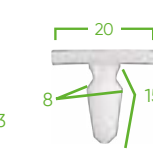

**13133** 35 35  
3,45€

OE 743707

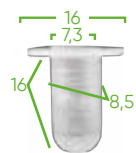

**13134** 30 30  
3,95€

OE 7703074022

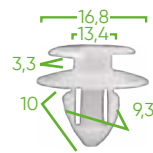

**13135** 35 35  
3,45€

OE 7703077059

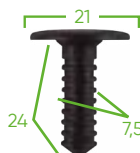

**13136** 15 15  
2,60€

OE 698317

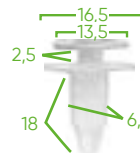

**13137** 25 25  
2,25€

OE 699502

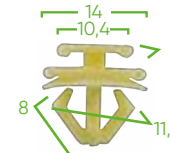

**13138** 30 30  
2,85€

OE 6995X3

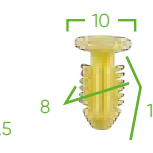

**13139** 40 40  
3,85€

OE 69945

## PARA FIAT

52900

34,00€

308  
PCS

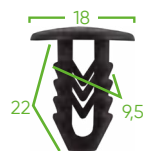

**13140** 30 30  
2,65€

OE 14591784



**13141** 20 10  
1,80€

OE 1459487

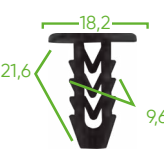

**13142** 25 25  
3,10€

OE 1300433650

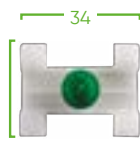

**13143** 8 8  
1,95€

OE 71717421

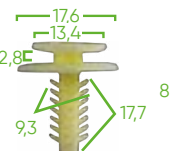

**13144** 25 25  
2,20€

OE 82456515

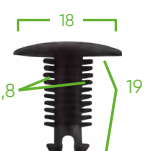

**13145** 25 25  
3,85€

OE 5757139



**13146** 20 8  
4,50€

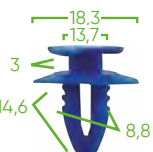

**13147** 25 25  
3,10€

OE 46306526



**13148** 25 25  
3,30€

OE 14591687



**13149** 25 25  
3,10€

OE 14592387



**13150** 30 30  
2,25€

OE 83468473

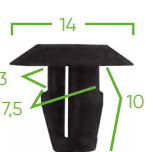

**13151** 15 50  
5,35€

OE 7677865

## PARA VOLVO

52901

34,00€

350  
PCS

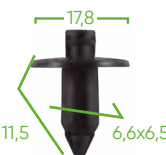

**13152** 25 25  
3,05€

OE 8099905N07

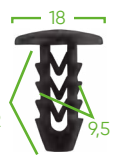

**13153** 30 30  
3,10€

OE 4292906



**13154** 20 20  
3,20€

OE 12681763



**13155** 40 40  
5,60€

OE 51131804205



**13156** 40 40  
3,30€

OE 947098

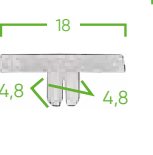

**13157** 40 40  
3,85€

OE 591740



**13158** 25 25  
3,75€

OE 6384801G00

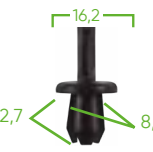

**13159** 20 20  
3,20€

OE 9133417



**13160** 40 40  
5,00€

OE 9133073



**13161** 30 30  
3,55€

OE 3272075327462B

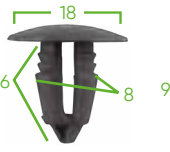

**13162** 20 20  
2,60€

OE 327462A



**13163** 20 20  
2,80€

OE 3923712

# SORTIMENTO DE CLIPS

## PARA VOLSKWAGEN

**52889**  
19,00€

**85**  
PCS

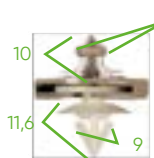

**13038** 2 2  
1,40€  
OE 1H0868243B

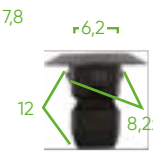

**13039** 10 10  
1,65€  
OE N90833801

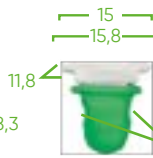

**13040** 8 8  
1,80€  
OE 3A0853575



**13041** 5 5  
1,55€  
OE 4A0853825



**13042** 15 15  
1,95€  
OE 6U085733

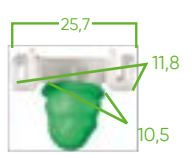

**13043** 3 3  
1,20€  
OE 3B0853576

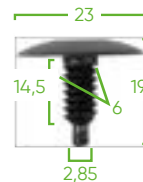

**13044** 6 6  
1,55€  
OE 1H0819055B01C

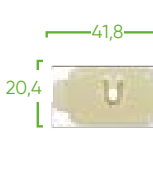

**13045** 5 5  
1,20€  
OE 443853909A

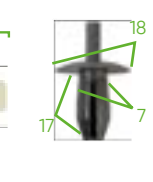

**13046** 6 6  
1,55€  
OE 171885767

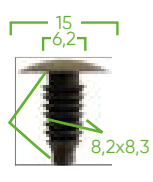

**13047** 5 5  
1,45€  
OE N9020160H

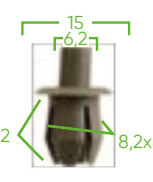

**13048** 10 10  
2,20€  
OE N0385501



**13049** 10 10  
2,05€  
OE 191941142

0,18 6 24 504

## PARA BMW

**52892**  
22,00€

**95**  
PCS

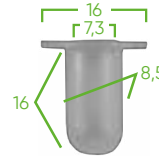

**13068** 25 25  
2,85€  
OE 51311802258



**13069** 30 30  
4,55€  
OE 51131804205

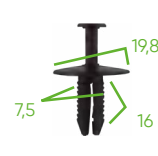

**13070** 10 10  
2,15€  
OE 51118174185



**13071** 10 10  
2,05€  
OE 51481938725



**13072** 15 15  
2,75€  
OE 703867299

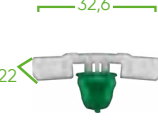

**13073** 5 5  
2,10€  
OE 51131960054

0,17 6 24 672

## PARA NISSAN

**52894**  
22,00€

**139**  
PCS

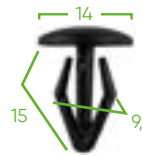

**13080** 15 15  
1,75€  
OE 76906T300



**13081** 20 20  
2,30€  
OE 0155300172

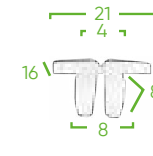

**13082** 10 10  
1,35€  
OE 68425H5000

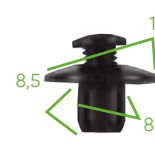

**13083** 6 6  
1,50€  
OE 75521611000

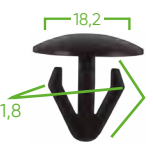

**13084** 20 20  
2,10€  
OE 62869N4700

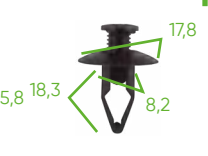

**13085** 5 5  
1,60€  
OE 6384401A00

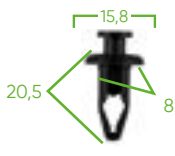

**13086** 12 5  
1,25€  
OE 7688257A00

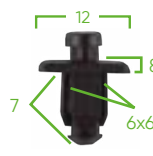

**13087** 25 25  
3,30€  
OE 6684101G00

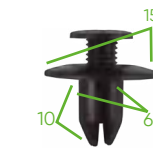

**13088** 10 10  
2,40€  
OE 1099830880

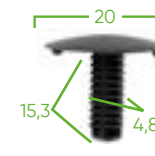

**13089** 10 10  
1,70€  
OE 8942798070

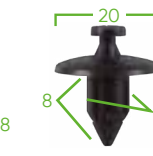

**13090** 8 8  
1,70€  
OE 6384801G00



**13091** 5 5  
1,25€  
OE 6385401A00

0,19 6 24 216

# SORTIMENTO DE CLIPS

UNIDADES NO CASO



UNIDADES POR SACO DE PEÇAS SOBRESSALENTES

SACOS POR SUBCAIXA / CAIXA



DESMANCHA DISPONÍVEL

## PARA AUDI

**52890**  
22,00€

**31**  
PCS



0,16 6 24 504

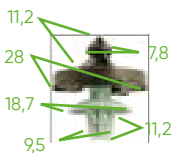

**13053** 10 10  
2,80€  
OE 357853575

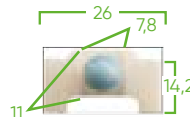

**13054** 5 5  
2,35€  
OE 1H0853585A

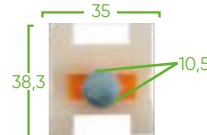

**13055** 3 3  
3,00€  
OE 3A0853575



**13050** 5 5  
1,55€  
OE 3B0868243



**13051** 5 5  
1,50€  
OE 1H0867199A



**13052** 3 3  
1,25€  
OE 1H0868243B

## PARA FORD

**52891**  
28,00€

**169**  
PCS



0,16 6 24 672



**13056** 8 8  
1,55€  
OE 388577S

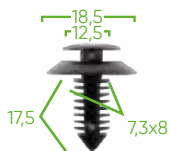

**13057** 5 5  
1,50€  
OE N801925S

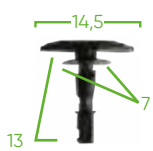

**13058** 20 20  
2,20€  
OE N806289S



**13059** 20 20  
2,35€  
OE N379830S

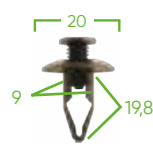

**13060** 5 5  
1,60€  
OE 1007932



**13061** 20 20  
2,65€  
OE 16500308

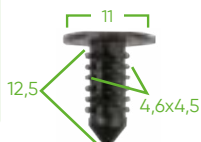

**13062** 20 20  
2,35€  
OE N803170S

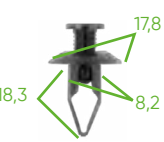

**13063** 6 6  
1,15€  
OE W706713S300

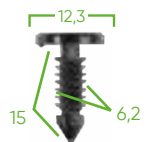

**13064** 20 20  
2,60€  
OE N388246S

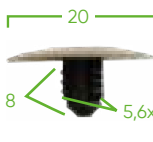

**13065** 15 15  
2,00€  
OE F22216774A

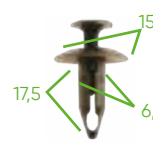

**13066** 5 5  
2,25€  
OE 1673046



**13067** 25 25  
2,55€  
OE FICZ16674A

## PARA BENZ

**52893**  
26,00€

**95**  
PCS



0,2 6 24 504

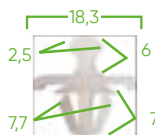

**13074** 30 30  
4,65€  
OE A0019884481



**13075** 20 20  
5,35€  
OE A0019882981

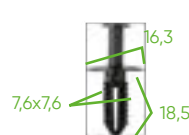

**13076** 15 15  
3,90€  
OE A1249900492



**13077** 4 4  
2,55€  
OE A0019888081



**13078** 6 6  
2,55€  
OE A1249880492

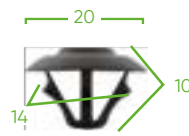

**13079** 20 20  
3,35€  
OE A0019880325



# SORTIMENTO DE CLIPS

## PARA RENAULT

**52897**  
38,00€ **300**  
PCS



0,43 6 24 360

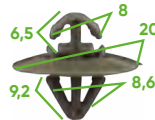

**13116** 50 50  
5,45€

OE 7703077421

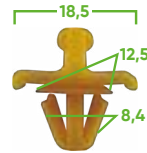

**13117** 50 50  
3,65€



**13118** 60 60  
15,85€

OE 7703081184

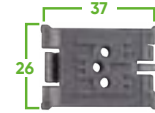

**13119** 15 15  
5,60€

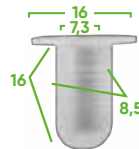

**13120** 60 60  
5,50€

OE 7703074022

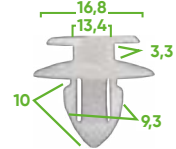

**13121** 65 65  
8,75€

OE 7703077059

## PARA MITSUBISHI

**52895**  
22,00€ **132**  
PCS



0,19 6 24 1.500



**13092** 15 15  
1,65€

OE 8942180270

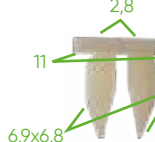

**13093** 30 30  
2,95€

OE 9018905013

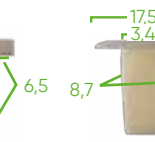

**13094** 10 10  
1,50€

OE MU480033

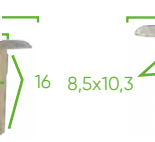

**13095** 6 6  
1,20€

OE 128100231

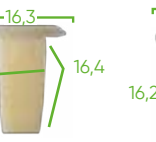

**13096** 8 8  
1,70€

OE MU480034

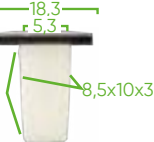

**13097** 3 3  
1,20€

OE MR138807



**13098** 4 4  
1,65€

OE MB253964



**13099** 30 30  
2,75€

OE HB121467



**13100** 3 3  
1,20€

OE MB271999

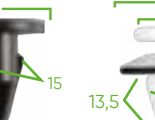

**13101** 8 8  
1,50€

OE MB696120



**13102** 5 5  
1,60€

OE MR200300

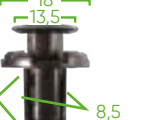

**13103** 10 10  
1,80€

OE MB846992

## PARA VAUXHALL / OPEL

**52898**  
36,00€ **300**  
PCS



0,45 6 24 360



**13122** 20 20  
1,95€

OE 90218614

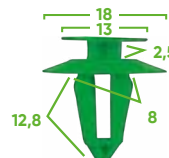

**13123** 40 40  
5,35€

OE 174864

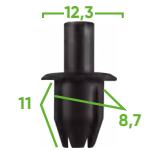

**13124** 100 100  
8,20€

OE N0385501

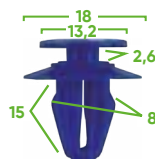

**13125** 50 50  
5,95€

OE 2345959

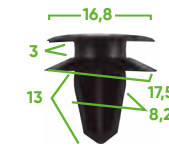

**13126** 50 50  
1,55€

OE 2240582



**13127** 40 40  
5,60€

OE 180942

# SORTIMENTO DE CLIPS

## UNIVERSAL

**52888**  
24,00€

**128**  
PCS



0,14 6 24 672

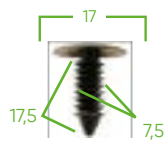

**13026** 8 8  
1,55€  
OE 388577S

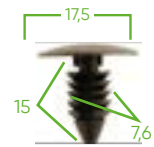

**13027** 10 10  
1,85€  
GENERAL USE

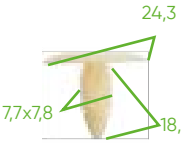

**13028** 6 6  
1,45€  
OE 6003423

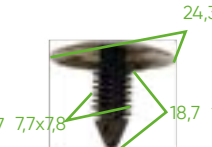

**13029** 6 6  
1,65€  
VW: N989022  
CHRYSLER: 6003349  
FORD: 385661

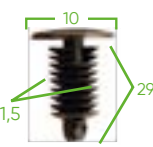

**13030** 25 25  
2,80€  
GM: 20699808  
CHRYSLER: 6502328

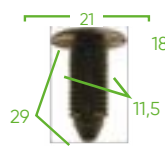

**13031** 4 4  
1,85€  
FORD: N804379S

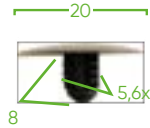

**13032** 15 15  
2,00€  
MAZDA: 6508197AA  
FORD: F22Z16774A

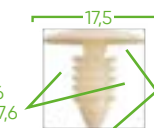

**13033** 10 10  
1,60€  
GM: 16674629  
FORD: N8061135

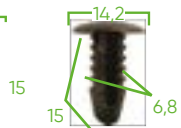

**13034** 20 20  
2,65€  
NISSAN: 0153301781

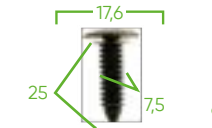

**13035** 6 6  
1,65€  
GM: 10124502  
BMW: 52201964201  
LAND ROVER:  
DZM100080

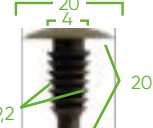

**13036** 6 6  
1,40€  
VW: N9020160H  
FORD: 6998849  
BMW: 51471904317  
OPEL: 2207713

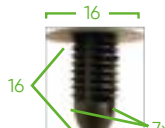

**13037** 12 12  
2,10€  
GENERAL USE

## PARA TAPÊÇARIA BMW MINI

**53720**  
19,00€

**112**  
PCS



0,18 6 24 216

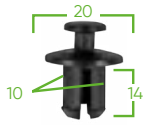

**14447** 7 6  
1,45€  
OE 51471911992

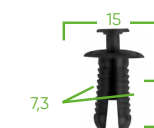

**14449** 13 10  
2,20€  
OE A0009905492

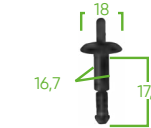

**14471** 5 5  
1,90€  
OE 51717002953

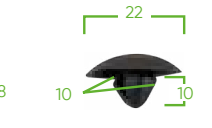

**14472** 5 5  
1,35€  
OE 51489119216

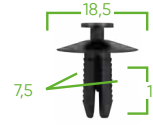

**14474** 8 8  
1,50€  
OE 51118174185



**14475** 6 6  
1,65€  
OE 2019900050



**14476** 9 9  
2,05€  
OE 51481915964

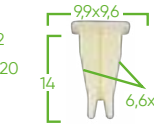

**14477** 15 15  
2,45€  
OE 0009881625



**14478** 15 15  
4,05€  
OE 7146976114

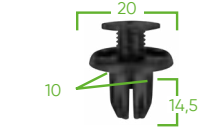

**14479** 6 6  
1,65€  
OE 91503SP0003

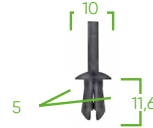

**14480** 15 15  
2,05€  
OE 51161943122

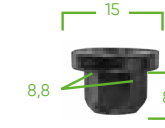

**14481** 8 8  
1,70€  
OE 51161943122

## PARA PAINÉIS DE PORTAS/MOLDURAS BMW MINI

**53719**  
19,00€

**92**  
PCS



0,16 6 24 216

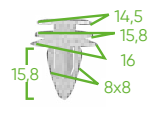

**14359** 8 4  
1,05€  
OE 51418224768

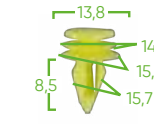

**14458** 8 8  
1,70€



**14459** 6 6  
1,45€

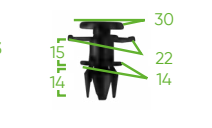

**14460** 2 2  
1,15€  
OE 7147122912

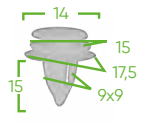

**14461** 8 8  
1,35€  
OE 51411973500

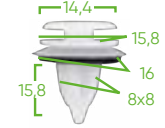

**14462** 8 8  
1,65€

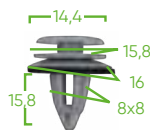

**14463** 8 8  
1,65€

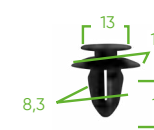

**14464** 10 10  
1,50€  
OE 611769

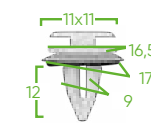

**14465** 10 10  
2,00€  
OE 7147145753

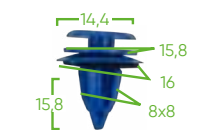

**14466** 8 8  
1,65€

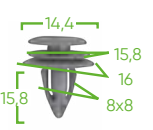

**14468** 8 8  
1,30€

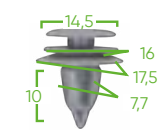

**14469** 8 8  
1,45€  
OE 7147133419

# SORTIMENTO DE CLIPS

UNIDADES NO CASO



UNIDADES POR SACO DE PEÇAS SOBRESSALENTES



DESMANCHA DISPONÍVEL



## PARA TAPEÇARIA MERCEDES-BENZ

**53718**  
19,00€

**151**  
PCS



 14422 6 6 1,50€ OE A0009913940	 14446 20 20 2,80€ OE 9903492	 14447 6 6 1,45€ OE 51471911992	 14448 12 12 2,05€ OE N105835019B9	 14449 10 10 2,20€ OE A0009905492	 14450 12 12 2,15€ OE N0385012
 14451 12 12 2,15€ OE A1239900092	 14452 25 25 2,55€	 14453 20 20 3,05€	 14455 12 12 2,10€	 14456 6 6 1,35€	 14457 10 10 1,70€ OE A1249900492

## PARA PAINÉIS DE PORTAS/MOLDURAS MERCEDES-BENZ

**53717**  
19,00€

**96**  
PCS



 14434 8 8 1,60€	 14435 6 6 1,45€	 14436 8 8 1,70€ OE A0009910198	 14437 6 6 1,45€ OE A0019912698	 14438 8 8 1,35€ OE A0089880978	 14439 8 8 1,75€ OE 0069884378
 14440 8 8 1,75€	 14441 10 10 1,65€ OE 0019884981	 14442 6 6 1,45€	 14443 8 8 1,45€	 14444 10 10 1,90€ OE 0019886081	 14445 10 10 1,45€

## PARA PAINÉIS DE PORTA/MOLDURAS/TAPEÇARIA VAG/SEAT/SKODA

**53716**  
19,00€

**79**  
PCS



 14422 6 6 1,50€ OE A0009913940	 14423 15 15 3,55€ OE 6E0837732	 14424 7 7 1,85€	 14425 2 2 2,05€ OE 6Q0868243	 14426 8 8 1,90€ OE 171201969	 14427 8 4 1,20€ OE 4D0807300
 14428 12 12 1,40€ OE 251823717	 14429 6 6 1,80€	 14430 3 3 2,25€ OE 8E0821989A	 14431 2 2 1,45€ OE 3B0868243	 14432 10 10 1,45€ OE 1H0823717	



# SORTIMENTO DE CLIPS

## PARA TAPEÇARIA PEUGEOT/CITROËN

**53715**

19,00€

**110**  
PCS

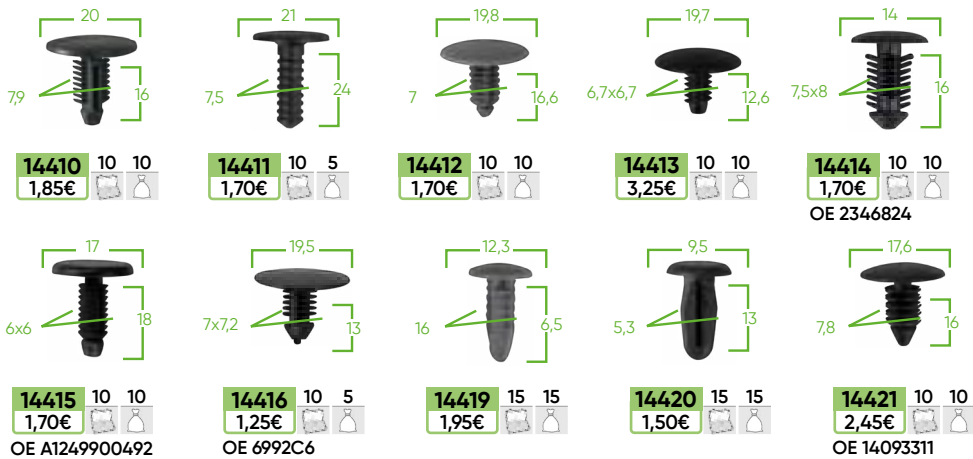
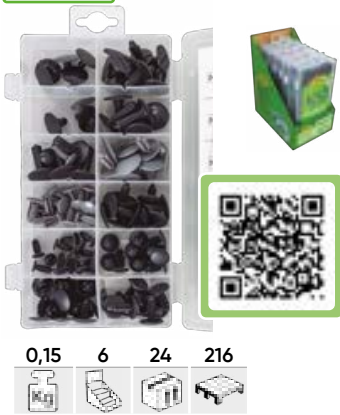

## PARA PAINÉIS DE PORTA PEUGEOT/CITROËN

**53713**

16,00€

**93**  
PCS

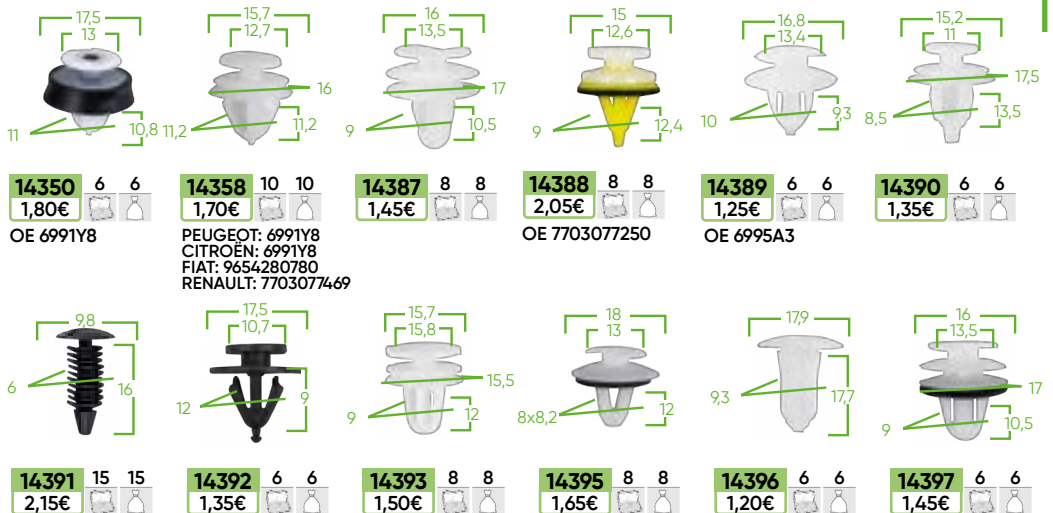

## PARA MOLDURAS PEUGEOT/CITROËN

**53714**

16,00€

**80**  
PCS

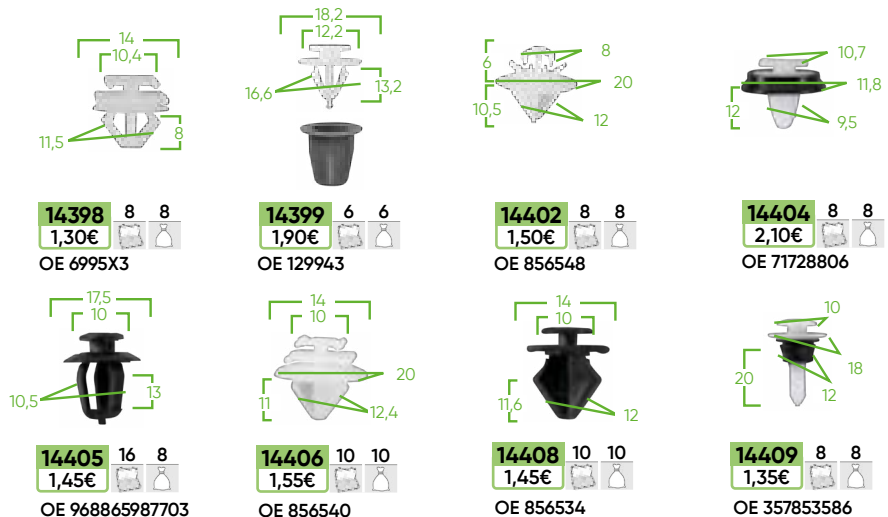

## ALICATE PARA EXTRAÇÃO DE GRAMPOS DE CARROCERIA

**53385**

18,00€

0,15 6 54 499



## JOGO 2 PALANÇAS EXTRAIR PEÇAS DE AUTOMÓVEL

**52851**

8,10€

0,24 6 60 800



## JOGO DE 6 PALANÇAS

**53110**

22,00€

1,42 6 12 144



**6**  
PCS









5"x8.5 / 5"x10.3  
5"x4.5 / 15"x8.5  
15"x10.3 / 15"x4.5mm

## PARA TAPEÇARIA **RENAULT / DACIA**

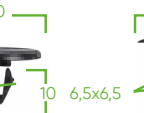
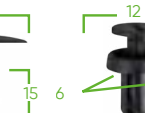
**53712**  
16,00€

**109**  
PCS













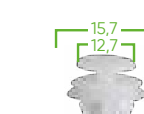

 14374 3 3 1,70€ OE 7703077435	 14375 15 15 1,85€	 14376 20 20 2,60€ OE 7L6868307	 14377 10 10 1,90€	 14378 12 12 1,90€	 14379 6 6 1,45€ OE 7703077117
 14381 10 10 1,70€	 14383 6 6 1,35€ OE 7703072360	 14382 10 10 1,85€ OE 7703077153	 14384 12 12 2,10€ OE W705956S300	 14416 5 5 1,25€ OE 6992C6	

## PARA MOLDURAS **RENAULT / DACIA**

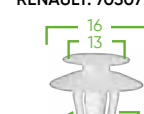
**53711**  
16,00€

**90**  
PCS











 14358 10 10 1,70€ PEUGEOT: 6991Y8 CITROËN: 6991Y8 FIAT: 9654280780 RENAULT: 703077469	 14364 10 10 1,90€ OPEL: 7701470779 NISSAN: 7703077421 RENAULT: 7703077421 IVECO: 500326896	 14365 10 10 1,90€ OPEL: 7701470779 NISSAN: 7703077421 RENAULT: 7703077421 IVECO: 500326896	 14356 12 10 1,90€ RENAULT: 7703077368 OPEL: 4430858	 14367 3 3 1,30€ OE 7L5853994	 14368 8 8 1,45€
 14370 3 3 3,00€	 14371 3 3 3,00€	 14366 8 8 1,45€ PEUGEOT: 6991Y8 CITROËN: 6991Y8 FIAT: 9654280780 RENAULT: 703077469	 14372 4 4 1,20€	 14369 15 15 4,95€ OE 7701061797	 14373 4 4 1,35€

## PARA PAINÉIS DE PORTA **RENAULT / DACIA**

**53710**  
16,00€

**85**  
PCS

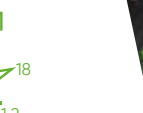

 14350 12 6 1,80€ OE 6991Y8	 14351 8 8 1,65€	 14352 7 7 1,30€ OE 51447780135	 14353 4 4 2,10€ OE 7703077476
 14355 8 8 1,70€ OE 7703077354	 14356 10 10 1,90€ OPEL: 4430858 RENAULT: 7703077368	 14357 10 10 1,90€ OE 7703077430	 14359 4 4 1,05€ OE 51418224768
 14361 8 8 1,70€	 14358 10 10 1,70€ PEUGEOT: 6991Y8 CITROËN: 6991Y8 FIAT: 9654280780 RENAULT: 7703077469		

## PÔSTER DE CLIPES

**15001**  
3,00€

- Pôster informativo dos cliques plásticos JBM. Com todas as informações de cada clipe (referência, preço, quantidades e medidas).



330x1000mm

COLETE



338

JAQUETA



338



**ROUPA**



**SERIE182**



## COLETE JBM

Tamanho M

**70001**  
35,00€

0,3 5 180

Tamanho L

**70002**  
37,50€

0,4 5 180

Tamanho XL

**70003**  
37,50€

0,4 5 180

**70007**  
35,00€

0,3 5 180

**70008**  
37,50€

0,4 5 180

**70009**  
37,50€

0,4 5 180



2 BOLSOS INTERIORES DE GRANDE CAPACIDADE



2 BOLSOS LATERAIS



Resistente ao frio

Térmica

Leve

## JAQUETA JBM

Tamanho M

**70004**  
42,00€

0,6 5 120

Tamanho L

**70005**  
42,00€

0,7 5 120

Tamanho XL

**70006**  
42,00€

0,7 5 120

**70010**  
42,00€

0,6 5 120

**70011**  
42,00€

0,7 5 120

**70012**  
42,00€

0,7 5 120



GOLA ALTA E COM FECHO NA FRENTE



TÊRÇOS BOLSOS EXTERIORES



Resistente ao frio

Térmica

Leve



CABIDE  
**13929**  
3,60€

0,05 20  
490mm



EXPOSITOR  
**METEXP**  
57,00€

6 1 16

DISPOSITIVOS ELETRÔNICOS JBM



340

PROMOTIONALS



340

EXPOSITORES E ACESSÓRIOS

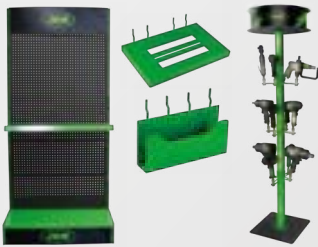

345

EMBALAGEM



347



# PROMOTIONALS





## CÂMARA ESPORTIVA

53865

0,30 36 432

48,00€



- ✓ **Corpo à prova d'água** que permite fotografar em profundidades de até 30 metros.
- ✓ **Display LCD** de alta resolução baseado na tecnologia LTPS.
- ✓ Bateria removível que é fácil de substituir.
- ✓ Gravação de vídeo digital, fotografia, exibição de vídeo e gravação de áudio.
- ✓ **Lente grande angular HD de 120° HD.**
- ✓ **Webcam.**
- ✓ Suporta cartões de memória de até **64GB.**
- ✓ **Suporta vários formatos** de gravação de vídeo.
- ✓ **Deteção de movimento e gravação em loop.**



GRAVAÇÃO DE ALTA DEFINIÇÃO

### PROJETADO PARA:

- Gravação de veículos
- Segurança residencial
- Fotografia
- Esportes ao ar livre
- Gravação em águas profundas
- Etc.



DISPLAY LTPS LCD DE ALTA RESOLUÇÃO



### ACESSÓRIOS:



## CADEIRA GIRATÓRIA

53956

18,4

353,00€

1

ALMOFADA DE ENCOSTO DE CABEÇA

DIMENSÕES 70X55X126-136CM

200Kg

- ✓ **Material:** PU
- ✓ **Espessura da estrutura de aço:** 1,2cm
- ✓ **Assento:** espuma moldada
- ✓ **Encosto:** espuma de poliuretano
- ✓ **Apoio de braço:** 2D
- ✓ **Elevador a gás:** Classe 3
- ✓ **Base de nylon:** 350mm



### BASE E ROLOS

15256 1,90 10  
36,00€

### APOIO DE BRAÇO DIREITO

15257 1,34 10  
27,50€

### APOIO DE BRAÇO ESQUERDO

15258 1,34 10  
27,50€

### AMORTECEDOR

15259 0,78 5  
18,00€

### CONJUNTO DE 5 ROLOS

15260 0,59 10  
22,50€



# CARPA STAND JBM 3x3m

53973

18,40

1

31

284,00€



## LATERAL PARA REF. 53973

15152

0,50

5

142,50€



Consiste em duas partes:  
- Parte lateral que cobre 3/4 partes da barraca.  
- Parte frontal que cobre 1/4 parte da barraca.  
Com zíper vertical como porta

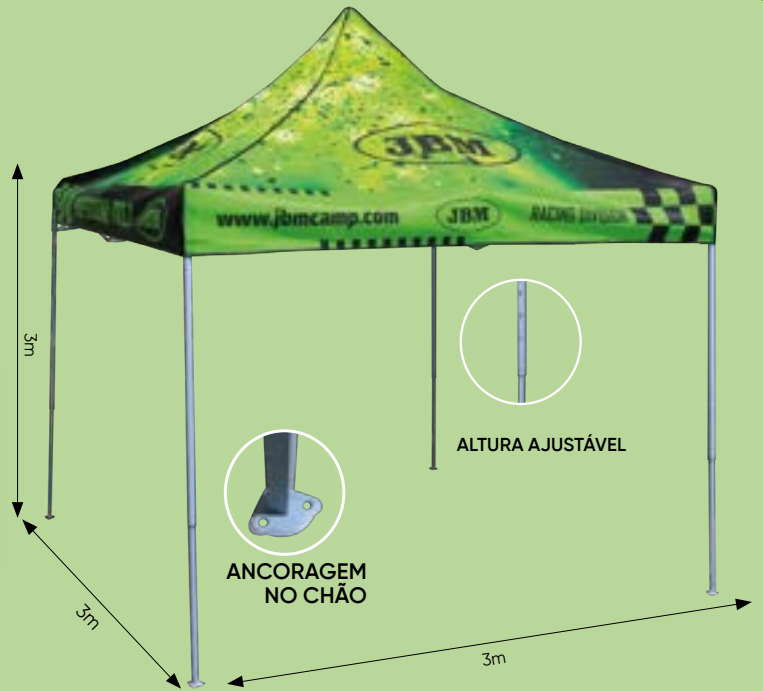

INCLUI COBERTURA PROTETORA DO SUPORTE JBM

14347

0,60

5

36,50€



# LIMPADOR DE VÁCUO DO ROBÔ

54020

3,4

4

85mm

350mm

350mm

288,00€



O robô inteligente realiza **limpeza e lavagem automaticamente**. Graças ao seu sistema de orientação espacial inteligente, ele pode limpar completamente a área de trabalho. É possível uma configuração flexível com seleção do modo de operação, com ajuste do nível de sucção e umidade e agendamento das tarefas para um horário específico.



4-5H 100-180min 14.8V 2600mAh



20W

3,4kg

68 dB

20cm/s

1200 Pa



Máxima superfície cubierta

Maximum covered area

120m<sup>2</sup>

Capacidad tanque de agua

Water tank capacity

300ml

Capacidad del depósito de polvo

Dust box capacity

300ml

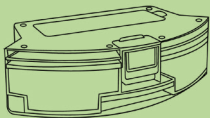

CONEXÃO DE APP



ESCOVA LATERAL ESQUERDA

15340

100

5,50€



ESCOVA LATERAL DIREITA

15341

100

5,50€



ESCOVA PRINCIPAL

15342

100

9,00€

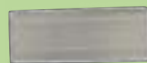

FILTRO HEPA

15343

100

9,50€



FERRAMENTA DE LIMPEZA

15344

100

6,50€



CONJUNTO DE 5 ESFREGÕES

15345

100

10,50€



ESTACION BASE

15346

30

24,00€



TOMA DE CORRENTE

15349

20

8,50€



## MOCHILA JBM

54043

42,50€

1,1

5

15



✓ **Miejsce do przechowywania i kieszenie:** Dwie komory umożliwiają przechowywanie m.in. laptopy do 17,3 cala oraz tablety.

✓ **Materiał:** Poliuretan; wodoodporny, wytrzymały i solidny plecak.

✓ **Lekki i wygodny:** Wygodne, oddychające plecy z siatki i ramiączka wykonane z gąbki.



## CANECA JBM

54076

8,00€

0,3

1



340ml

Ø 80mm

95mm



## LAMPADA A LED PORTATILE COM LANTERNA / ALTAVOZ / CARREGADOR

53199

24,00€

0,4

18

306



1- LANTERNA  
2- CARREGADOR  
3- ALTAVOZ



187mm

93mm

## CAMISA POLO JBM

REF.	TALLA	kg	cm	cm	€
13243	M	0,25	100	600	12,50€
13244	L	0,26	100	600	12,50€
13245	XL	0,28	100	600	12,50€



## PEN 4 CORES PROMOCIONAL JBM

53533

1,00€

0,01

50

1.000



- Caneta de 4 cores: azul, vermelho, preto, verde.



COM PONTEIRO TRASEIRO DE BORRACHA PARA ESCREVER EM TELAS SENSÍVEIS AO TOQUE



## BOLSA JBM

13968

3,00€



## SCOOTER ELÉTRICO 36V 350W MOTOR SEM ESCOVA

53920



537,00€

- Dimensões desdobradas: 109x42x109 cm
- Dimensões da plataforma: 67x14 cm
- Altura do volante: 109 cm
- Máx. alcance: até 26 km
- Capacidade de escalada: até 15°
- Carga útil máxima: até 107 kg



Gerencie todas as **características técnicas** do seu celular:

- Indicador de nível de bateria.
- Alterar o modo de limite de velocidade.
- Altere o modo de inicialização.
- Controle a velocidade com que você dirige.
- Liga / desliga a luz LED.
- Trava a scooter para que não possa ser usada ou roubada (bloqueio do motor).

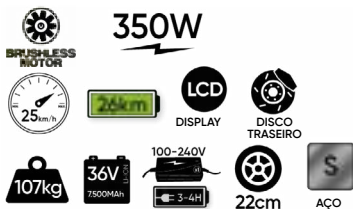

DIMENSÕES DOBRADAS  
109x42x46cm

DISPLAY  
LCD

## BICICLETA ESTÁTICA

53930



276,00€

- Tempo: 0: 00~99:59 min
- Distância: 0,00~9999 milhas (km)
- Distância total: 0,00~9999 milhas (km)
- Velocidade: 0,0~9999
- Calorias: 0,0~9999 kcal
- Pulso: 40~240 bpm
- Bateria: AAA, 2 unid.
- Temperatura de operação: 0 ~ 40°C (32-104°F)
- Temperatura de armazenamento: 10 ~ 60°C (14-168°F)

- FUNÇÕES DE MEDIÇÃO:
- TEMPO
  - RAPIDEZ
  - DISTÂNCIA
  - CALORIAS
  - DISTÂNCIA TOTAL
  - PULSO
  - VARREDURA



ASSENTO  
CONFORTÁVEL

AJUSTE DE  
ESFORÇO

RODAS PARA  
TRANSPORTE

ALÇA CONVENIENTE

## PATINETE DE 2 RODAS - SCOOTER

53504



48,00€

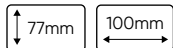

AJUSTÁVEL



## PASSADEIRA

53934



602,00€

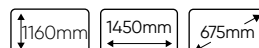

- Tensão de alimentação: 220 V - 240 V
- Frequência da rede: 50 - 60 Hz
- Potência nominal: 550 W
- Máx. potência: 1500 W (2,0 HP)
- Velocidade: 1,0 - 12 níveis (velocidade máxima de 9,5 km/h)
- Tamanho dobrado: 970\*675\*1275 mm
- Tamanho da trilha: 400\*1100 mm
- Visor: 3,5", luz de fundo azul

FUNÇÃO REPRESENTAÇÃO:

- TEMPO
- DISTÂNCIA
- VELOCIDADE
- CALORIAS
- PULSO

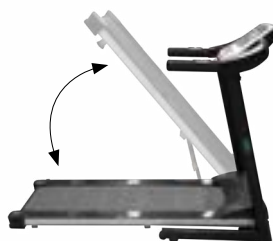



## GRELHA BBQ

53931

104,00€



- Material: ferro e fios
- Espessura: 0,4 mm
- Revestimento: tampa - pó preto, tigela - porcelana preta
- Grelha de cozimento: 43x40 cm, cromo
- Grelha de carvão: 36x36 cm, galvanizada
- Altura de trabalho durante o cozimento: 59 cm
- Pernas: 430 de aço inoxidável, 19 mm de diâmetro

ABERTURA NA TAMPA



REVESTIMENTO:  
TAMPA - PÓ PRETO,  
TIGELA - PORCELANA  
PRETA

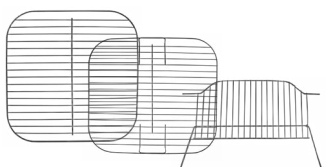

UMA GRELHA DE COZIMENTO, UMA GRELHA DE CARVÃO E UMA GRELHA DE AQUECIMENTO



PERNAS DE AÇO INOXIDÁVEL

460MM



PRATELEIRA LATERAL,  
2 RODAS,  
ALÇA E TIGELA

## SUPORTE DE PRESUNTO

14975

64,00€



- Dimensões: 500x330x440mm
- Peso: 2,18 kg



## CONJUNTO DE 3 FACAS

53511

23,00€

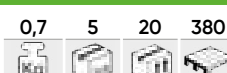

3 PCS

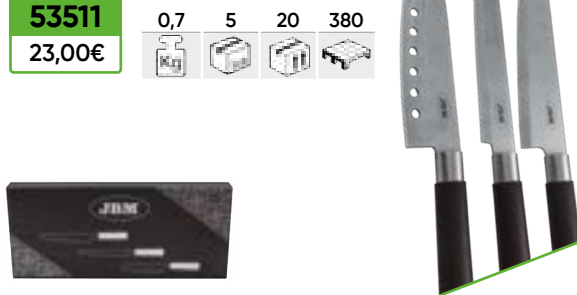

## BOLSA REFRIGERADA JBM

53949

4,50€

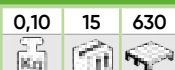

53950

4,50€



350mm  
675mm  
675mm



## CONJUNTO DE 24 TALHERES

53512

41,00€



24 PCS



## GUARDA-CHUVA PROMOCIONAL JBM

52857

7,50€

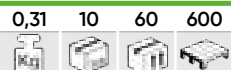

84mm



## COLAR DE PÉROLAS

53513

9,00€



## CONJUNTO DE 2 TOALHAS

53510

24,00€

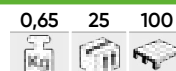

2 PCS



## EXPOSITOR DE FERRAMENTAS VAZIO

53877

430,50€

37,7

1

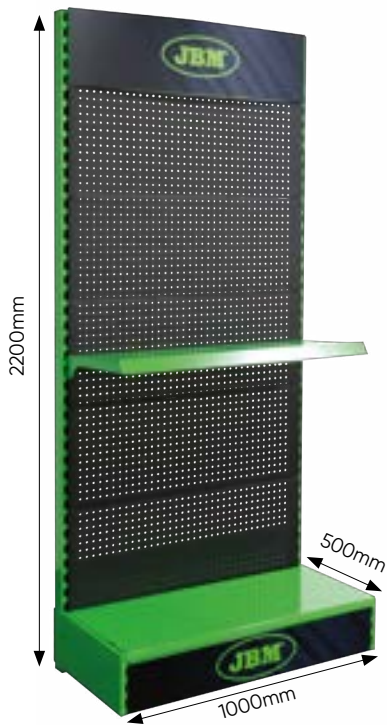

CONTÉM

14945 x1

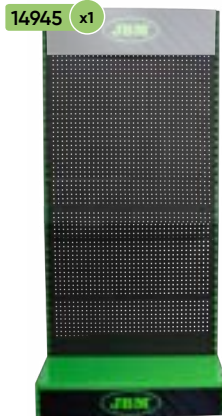

11318 x1



14380 x20

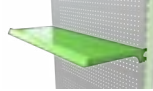

14946 x1



## PEÇAS DE EXPOSITOR

DE EXPOSITOR

14946

58,00€

2,7

1

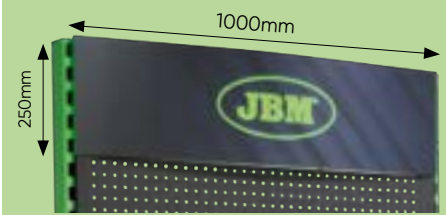

14947

201,50€

6,3

1

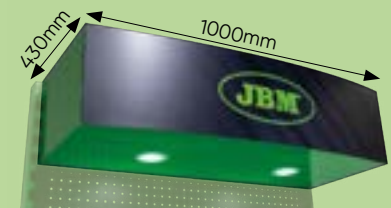

14380

51,00€

5

1

27

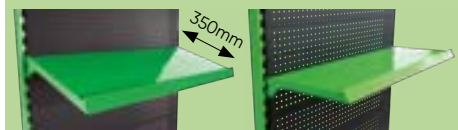

14996

64,50€

5,8

1



14948

251,50€

21,5

1



14945

303,50€

21,5

1

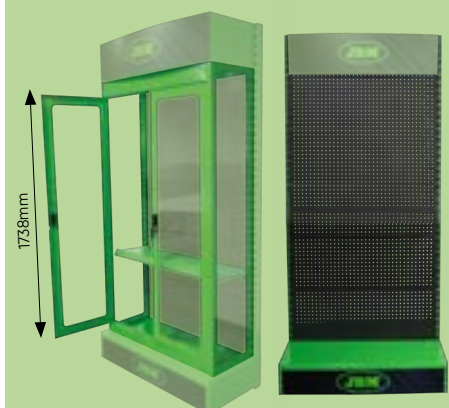

## EXPOSITOR DE FERRAMENTAS + ILUMINAÇÃO

53878

574,00€

41,3

1



## EXPOSITOR DE FERRAMENTAS + ILUMINAÇÃO E PORTAS

53879

838,50€

62,8

1



CONTÉM

14945 x1



14380 x1

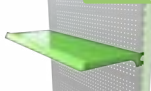

14947 x1



11318 x20



CONTÉM

14945 x1



14948 x1



x20 11318



14996 x1

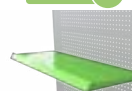

14947 x1





## BANDEJA

**14622**  
17,00€

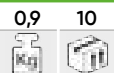

PARA REF. 60001, 60003, 60004, 60020

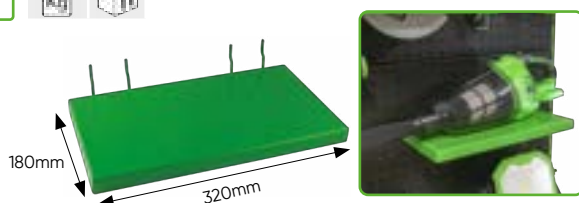

**14624**  
17,00€



PARA REF. 60007, 60010, 60011

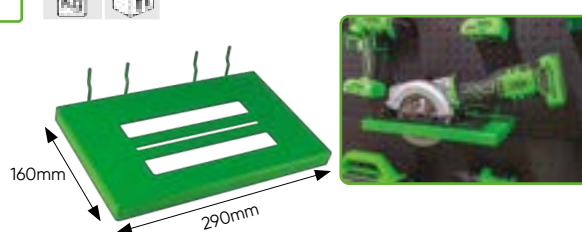

## CABIDES

**14626**  
7,00€

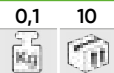

PARA REF. 60023

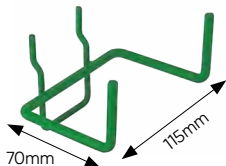

**14623**  
8,00€



PARA REF. 60005, 60006, 60018

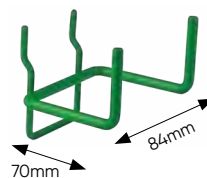

## CABIDE

PONTA COMPRIDA

**11318**  
2,50€



PONTA DECHADA

**51315**  
2,50€

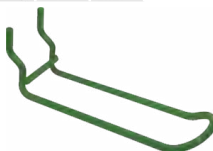

**GANCHO** PARA REF. 60008, 60009

**14625**  
14,00€

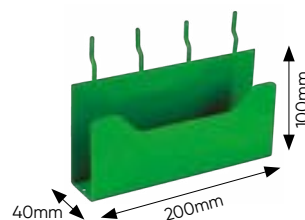

PARA FERRAMENTAS PNEUMÁTICAS

**14034**  
9,00€



106mm

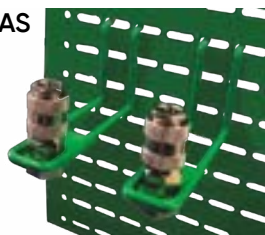

**EXPOSITOR DE FERRAMENTA PNEUMÁTICA**

**53492**  
379,50€



EXPOSITOR SEM FERRAMENTAS



## EXPOSITOR PARA TAPETE

**METEXP**  
57,00€





## CAIXA DE FERRAMENTAS MANUAIS DE REPOSIÇÃO

REF.	cm			€
14922	14,5x9x10	0,10	100	1,65€
14923	17,5x9x7	0,10	100	1,65€
14924	24x11x7	0,10	100	1,65€
14925	31,5x13x4	0,10	100	1,65€
14926	32x8,5x7	0,10	100	1,90€



## SELO DE GARANTIA JBM

14807

0,45

6

24

864

11,00€



- 75mm de lar. x 125m de comp.
- Feito de polipropileno
- Adesivo solvente
- Espessura: 28 microns



TODOS OS IDIOMAS  
NO MESMO SELO

## CAIXA DE CARTÃO DE NATAL PROMOCIONAL

REF.	cm				€
14976	80x31x60	2,20	1	80	27,50€
15056	40x30x61	1,60	1	70	17,00€
13717	76x14x29	0,90	1	200	11,50€
14083	80x28x49	1,80	1	90	19,50€



14083



14976



13717



15056



## CAIXA DE PAPELÃO JBM



12950



14189

14507











15064

REF.	cm				€
11330	19x10x11	0,05	50	4.200	1,00€
12952	40x30x20	0,40	30	360	2,50€
15051	40x32x30	0,40	20	160	3,00€
14974	54x40x24	0,65	20	150	3,50€
13217	57x30x25	0,55	15	150	3,50€
12950	60x40x30	1	15	75	3,50€

REF.	CARACTERÍSTICAS				€
14189	Canal tripla de caixa palete americana 120x80x100cm	10	1	40	28,50€
14507	Caixa paleta europeia 120x98x80cm	8	1	40	52,50€

# LEGENDA

## Legenda dados referencias

-  Peso do artigo em kilogramos
-  Quantidade de artigo por sub-caixa
-  Quantidade de artigo por expositor
-  Quantidade de artigo por embalagem
-  Quantidade de artigo por caixa
-  Quantidade de embalagens por caixa
-  Quantidade de artigo por palete
-  Apresentado em blister
-  Produto novo

## Legenda características generales

-  Capacidade por volume
-  Com ímán
-  Peso suportado pelo ímán
-  Peso que suporta o artigo
-  Nível de ruído (decibéis) db
-  Peso
-  Leve
-  Zoom
-  Conexão bluetooth
-  Conexão USB
-  Material de Alumínio
-  Cromado

## Legenda de ferramentas

-  Chave quadrada
-  Chave de 12 faces
-  Chave de 12 faces (2)
-  Chave hexagonal
-  Chave de ponta XZN
-  Chave twist
-  Chave spline
-  Bits Slotted
-  Bits ribe
-  Bits Phillips (estrela)
-  Bits Pozidriv (estrela dupla)
-  Bits quatro faces
-  Bits torx inviolável
-  Bits torx inviolável - XZN
-  Bits torx
-  Bits três faces
-  Bits TS 5 faces
-  Bits de 12 faces
-  Bits tensor
-  Bits Allen
-  Bit mariposa
-  Bit allen
-  Allen
-  Cabota normal
-  Cabota redonda

## Legenda de productos neumáticos

-  Rotações por minuto (geral)
-  Rotações por minuto (frente)
-  Rotações por minuto (trás)
-  Newton-metro(Nm) / Kilogramos(Kg)
-  Libra por polegada quadrada
-  Unidade de pressão (Bar)
-  Entrada de ar
-  Saída traserira
-  Saída traseira de 360°
-  Saída pela frente
-  Saída pela frente
-  Saída pela frente
-  Medidas
-  Pega ergonómica
-  Órbita do disco
-  Diâmetro do disco
-  Tamanho da broca
-  Medida de entrada broca
-  Movimento de 360°
-  N° de velocidades
-  Cavalos de força
-  Mecanismo martelo duplo
-  Ângulo de 90°

# LEGENDA

## Legenda de produtos electrónicos



Tipo de Led: SMD



Tipo de Led: COB



Tipo de Led: Cree XP-E



Quantidade / potência Led



Quantidade de Leds



Distância de iluminação



3 intensidades de luz



Fluxo luminoso (Lumen)



Luz dispersa



Luz concentrada



Quantidade de tipos de flash



Potência Volts/Watts



Duração da bateria



Duração da carga



Tipo de bateria



Quantidade de pilhas: AAA



Transformador / tomada de parede



Carregador com USB



Toma de isqueiro



Base inclinada



Base inclinada



Gancho



Gancho giratório



Comprimento do cabo



Resistente a choques



Grau de proteção IP



Com íman

## Legenda de produtos utilitários



Compressor de molas



Desmontagem de amortecedores

## Legenda produtos lubrificantes



Capacidade do funil



Fluxo

## Legenda acessórios



Atinge os 1.300°



Dos tipos de chama

## Legendas de certificação



Certificado CE



Norma de luvas de proteção



Cumprimento da lei de segurança de produtos alemães.





# INDICE NUMERICO

REF.	pag.	PDR	REF.	pag.	PDR	REF.	pag.	PDR	REF.	pag.	PDR
10000	246	7,00€	10566	39	3,50€	10639	255	10,90€	10813	318	0,30€
10054	192	2,50€	10567	39	3,50€	10642	60	10,00€	10823	321	0,20€
10055	192	3,00€	10568	39	4,00€	10643	60	10,00€	10824	321	0,20€
10485	193	8,10€	10569	39	4,50€	10644	60	10,00€	10825	321	0,20€
10486	193	8,00€	10570	39	4,50€	10671	264	15,20€	10826	321	0,40€
10494	193	6,50€	10571	39	5,00€	10672	205	9,50€	10827	321	0,60€
10495	193	3,00€	10579	40	3,00€	10673	205	9,50€	10828	321	0,45€
10496	193	3,00€	10580	40	3,10€	10674	205	9,50€	10829	321	0,20€
10497	193	3,00€	10581	40	3,40€	10675	205	9,50€	10830	321	0,20€
10498	193	3,00€	10582	40	4,00€	10720	274	24,50€	10831	321	0,20€
10499	193	3,00€	10583	40	4,15€	10721	274	19,00€	10832	321	0,20€
10500	193	3,00€	10584	40	5,05€	10722	274	24,50€	10833	321	0,20€
10501	193	8,10€	10585	40	6,75€	10723	274	29,50€	10834	321	0,25€
10502	193	3,50€	10586	40	7,60€	10724	274	29,50€	10835	321	0,25€
10526	60	10,00€	10587	40	9,80€	10727	78	23,00€	10836	321	0,30€
10527	38	13,05€	10588	40	10,50€	10731	78	18,00€	10837	321	0,30€
10528	38	15,80€	10589	40	2,00€	10732	78	18,50€	10838	321	0,30€
10529	38	18,00€	10590	40	2,40€	10733	78	17,50€	10839	321	0,40€
10530	38	28,65€	10591	42	2,50€	10735	78	20,00€	10840	321	0,35€
10531	39	3,00€	10592	42	2,55€	10750	122	13,00€	10868	325	0,30€
10532	39	2,70€	10593	42	3,15€	10751	122	15,00€	10869	325	0,30€
10533	39	3,00€	10594	42	3,20€	10761	274	16,00€	10870	325	0,45€
10534	39	3,25€	10595	42	3,35€	10762	274	23,50€	10871	325	0,30€
10535	39	3,50€	10596	42	4,25€	10766	122/128	2,80€	10872	325	0,40€
10536	39	3,65€	10597	42	4,50€	10767	246	21,00€	10873	325	0,45€
10537	39	3,90€	10598	42	4,60€	10768	255	112,50€	10874	325	0,30€
10538	39	4,30€	10599	42	6,00€	10769	255	21,00€	10875	325	0,40€
10539	39	4,75€	10600	42	6,25€	10770	255	6,00€	10876	325	0,45€
10540	39	5,25€	10601	42	6,50€	10772	320	0,05€	10877	319	0,25€
10541	39	5,55€	10602	42	7,05€	10773	320	0,10€	10878	319	0,30€
10542	39	5,85€	10603	42	2,10€	10774	320	0,10€	10879	319	0,20€
10543	39	7,00€	10604	42	2,25€	10775	320	0,15€	10880	319	0,20€
10544	39	8,10€	10617	38	14,05€	10776	320	0,20€	10881	319	0,25€
10545	39	9,75€	10618	38	15,10€	10777	320	0,20€	10882	317	0,25€
10546	39	11,55€	10619	38	15,65€	10778	320	0,35€	10883	317	0,25€
10547	39	13,45€	10620	38	16,15€	10779	320/318	0,05€	10884	317	0,25€
10548	39	1,75€	10621	38	9,50€	10780	320/318	0,05€	10885	327	0,20€
10549	39	2,00€	10622	38	10,00€	10781	320/318	0,05€	10886	327	0,20€
10550	39	2,15€	10623	38	12,60€	10782	320	0,05€	10887	327	0,25€
10551	39	2,15€	10624	38	13,50€	10783	320	0,05€	10888	327	0,30€
10552	36	7,10€	10625	38	15,65€	10784	320/318	0,05€	10889	327	0,30€
10553	36	7,35€	10626	38	17,75€	10785	320/318	0,10€	10890	327	0,35€
10554	36	7,50€	10627	40	2,80€	10786	320/318	0,15€	10891	327	0,25€
10555	36	7,80€	10628	40	3,10€	10787	320	0,05€	10892	327	0,30€
10556	36	8,10€	10629	40	3,65€	10788	320	0,05€	10893	327	0,25€
10557	36	8,10€	10630	40	3,90€	10789	320	0,05€	10894	327	0,20€
10558	36	9,35€	10631	40	4,20€	10790	320	0,05€	10895	327	0,20€
10559	36	9,50€	10632	40	5,30€	10791	320	0,05€	10896	327	0,30€
10560	36	10,60€	10633	40	6,60€	10792	320	0,05€	10897	327	0,30€
10561	36	10,95€	10634	40	7,80€	10793	317	0,25€	10898	327	0,30€
10562	36	12,30€	10635	40	8,15€	10794	317	0,40€	10899	327	0,30€
10563	36	12,45€	10636	40	8,80€	10795	317	0,60€	10900	327	0,30€
10564	39	2,50€	10637	40	12,05€	10805	318	0,10€	10901	327	0,25€
10565	39	3,50€	10638	40	12,65€	10812	318	0,30€	10902	327	0,30€

REF.	pag.	PDR
10905	327	0,25€
10906	327	0,25€
10907	327	0,25€
10908	327	0,30€
10909	327	0,30€
10910	327	0,30€
10911	327	0,30€
10912	327	0,25€
10913	327	0,30€
10914	327	0,25€
10915	326/327	0,25€
10916	327	0,30€
10917	326/327	0,30€
10918	326/327	0,30€
10919	326/327	0,30€
10920	326/327	0,25€
10921	326/327	0,30€
10923	117	1,10€
10925	246	18,00€
10945	288	2,30€
10953	195	12,50€
10955	180	11,00€
10961	118	13,00€
10964	174/286	9,00€
10965	174/286	6,00€
10966	174/286	13,50€
10993	263	116,55€
11093	118	4,00€
11095	274	31,00€
11098	274	56,50€
11100	273	24,25€
11101	273	153,50€
11102	273	6,60€
11103	122	5,50€
11106	182	3,00€
11107	118	4,50€
11121	150/155	3,50€
11122	150/155	4,50€
11123	150/155	5,50€
11124	155	6,50€
11125	155	7,00€
11126	155	10,00€
11127	155	11,50€
11128	155	11,50€
11129	155	11,50€
11130	155	12,00€
11131	155	11,50€
11132	155	11,00€
11133	155	11,00€
11134	155	12,00€
11135	155	14,00€
11136	155	14,00€
11137	155	14,50€
11138	155	15,00€
11139	155	15,50€
11140	155	16,50€

REF.	pag.	PDR
11141	155	17,00€
11142	155	17,00€
11143	155	21,50€
11144	155	27,00€
11145	155	29,00€
11146	155	30,50€
11147	155	36,00€
11148	155	38,00€
11149	155	40,50€
11150	155	44,00€
11151	155	50,50€
11152	155	56,50€
11153	154/155	19,00€
11154	155	19,50€
11155	154/155	20,00€
11156	155	21,50€
11157	155	24,00€
11158	154/155	23,50€
11159	155	25,00€
11160	155	24,50€
11161	155	26,00€
11162	155	26,50€
11163	155	27,00€
11164	155	27,50€
11165	155	28,00€
11166	155	28,00€
11167	155	34,00€
11168	155	33,50€
11169	155	35,50€
11170	155	36,00€
11171	155	40,00€
11172	155	43,00€
11173	155	42,00€
11174	155	42,00€
11175	155	43,50€
11176	155	44,50€
11177	155	49,00€
11178	155	47,50€
11179	155	51,50€
11180	155	52,50€
11181	155	58,00€
11182	155	59,00€
11183	155	63,50€
11184	155	77,50€
11185	155	79,00€
11186	155	80,50€
11187	155	87,50€
11188	155	91,00€
11189	155	98,50€
11190	155	122,00€
11191	155	117,50€
11192	155	133,50€
11193	155	147,00€
11194	155	155,00€
11195	150/155	3,50€
11212	48	5,00€

REF.	pag.	PDR
11213	48	10,55€
11214	48	12,50€
11219	270	659,00€
11244	42	8,50€
11245	42	9,15€
11246	42	12,35€
11247	42	14,00€
11248	42	14,55€
11249	42	26,50€
11250	41	5,50€
11251	41	7,90€
11252	41	9,00€
11253	41	9,50€
11254	41	9,45€
11255	41	10,85€
11256	41	11,80€
11257	41	13,25€
11258	41	7,30€
11259	41	8,30€
11260	41	9,75€
11261	41	11,35€
11262	41	13,50€
11313	79	53,50€
11314	151	8,50€
11315	151	8,50€
11316	151	8,50€
11318	346	2,50€
11323	261	16,00€
11324	123	17,50€
11325	123	17,50€
11329	270/284	564,00€
11330	347	1,00€
11360	29	2,60€
11361	29	3,20€
11362	29	5,20€
11363	29	3,90€
11364	29	4,50€
11365	29	9,40€
11374	180	5,50€
11375	180	6,50€
11376	180	5,50€
11377	180	5,50€
11378	180	6,50€
11379	180	6,00€
11380	180	6,50€
11381	180	6,50€
11382	180	6,00€
11383	180	6,00€
11384	180	6,00€
11385	180	5,50€
11386	180	6,00€
11387	180	6,00€
11388	180	6,00€
11389	180	6,00€
11390	180	6,00€
11391	180	6,50€

REF.	pag.	PDR
11392	180	6,00€
11393	180	6,00€
11394	180	6,00€
11492	197	36,50€
11493	197	39,00€
11494	197	42,30€
11541	161	8,00€
11542	161	7,50€
11543	161	7,50€
11544	161	6,50€
11545	161	9,50€
11546	161	6,50€
11547	161	6,50€
11613	155	10,00€
11614	155	12,00€
11615	155	12,50€
11616	155	15,50€
11617	155	16,50€
11618	155	16,50€
11619	155	17,00€
11621	155	273,00€
11622	155	341,60€
11623	155	380,00€
11624	155	151,00€
11625	155	242,50€
11628	155	9,50€
11639	41	4,00€
11640	41	4,50€
11641	41	5,00€
11642	41	5,00€
11643	41	6,00€
11644	41	7,00€
11645	41	7,00€
11646	41	9,45€
11867	250	9,00€
11878	214	4,10€
11879	214	5,10€
11880	214	10,50€
11890	304	0,55€
11891	304	0,50€
11892	264	12,50€
11893	190	7,00€
11894	190	7,00€
11895	190	8,65€
11896	190	8,80€
11897	174/285	155,00€
11900	300	3,50€
11901	300	2,50€
11902	300	3,50€
11903	300	5,00€
11904	300	2,00€
11905	300	1,50€
11906	300	8,50€
11907	300	11,00€
11936	182	4,00€
11937	182	5,00€

REF.	pag.	PDR
11938	152	39,00€
11939	255	62,50€
11945	56	7,00€
11946	56	4,50€
11947	56	19,00€
11950	263	18,00€
11956	137	5,50€
11957	137	5,50€
11959	169	10,50€
11960	291/300	1,50€
11962	150/154	7,50€
11963	154	9,00€
11964	154	12,50€
11965	154	16,00€
11966	154	18,00€
11967	154	18,00€
11974	272	1,80€
11975	272	1,80€
11976	272	1,80€
11977	272	1,80€
11978	272	1,80€
11979	272	1,80€
11980	272	1,80€
11981	272	1,80€
11982	272	1,80€
11983	272	1,80€
11989	118	2,00€
11990	150/152	14,00€
11992	270/284	65,00€
11994	77	33,00€
11996	77	44,50€
11997	77	35,00€
11998	77	48,50€
12009	139	11,00€
12022	169/264	33,70€
12029	32/196	4,50€
12030	32/196	6,50€
12032	261	7,50€
12044	249	147,00€
12046	258	385,00€
12055	286	20,00€
12056	246	57,00€
12060	49	2,50€
12061	150/151/155	9,50€
12062	150/151/155	9,50€
12063	150/151/155	9,50€
12064	150/155	9,00€
12065	150/151/155	9,00€
12066	150/151/155	9,00€
12067	150/155	9,50€
12068	150/151/155	9,50€
12069	150/151/155	9,50€
12070	150/151/155	10,50€
12071	150/151/155	11,00€
12072	150/155	12,00€
12074	150/152	11,50€

REF.	pag.	PDR
12075	150/152	15,50€
12200	208	12,00€
12889	264	12,00€
12901	186	5,20€
12902	299	5,70€
12908	299	5,70€
12910	299	5,70€
12915	299	15,50€
12920	299	9,80€
12923	299	9,80€
12924	299	5,70€
12925	299	9,80€
12926	200	21,50€
12927	200	21,50€
12928	200	22,00€
12929	200	23,00€
12930	200	23,50€
12937	150/152	9,50€
12938	153	10,00€
12939	153	10,00€
12940	153	10,00€
12941	153	10,00€
12942	153	10,00€
12943	153	10,00€
12944	153	10,00€
12945	153	10,50€
12950	347	3,50€
12952	347	2,50€
12954	327	0,25€
12955	160	27,80€
12956	160	27,80€
12957	160	27,80€
12958	160	27,80€
12959	160	27,80€
12960	160	27,80€
12961	160	27,80€
12964	58	1,50€
12965	58	2,00€
12973	300	1,00€
12974	177	21,00€
12975	177	23,00€
12977	208	33,00€
12984	155	288,50€
12987	142	1,50€
12988	148	12,00€
12995	56	7,00€
12996	56	7,00€
12997	56	7,50€
12998	56	9,00€
12999	56	9,50€
13002	328	1,45€
13003	328	1,70€
13004	328	1,85€
13005	328	1,25€
13006	328	1,40€
13007	328	1,30€

REF.	pag.	PDR
13008	328	2,25€
13009	328	1,65€
13010	328	1,75€
13011	328	1,15€
13012	328	1,80€
13013	328	1,75€
13014	328	1,45€
13015	328	1,20€
13016	328	1,15€
13017	328	2,60€
13018	328	1,45€
13019	328	1,75€
13020	328	1,70€
13021	328	1,30€
13022	328	2,10€
13023	328	1,50€
13024	328	2,45€
13025	328	1,50€
13026	333	1,55€
13027	333	1,85€
13028	333	1,45€
13029	333	1,65€
13030	333	2,80€
13031	333	1,85€
13032	333	2,00€
13033	333	1,60€
13034	333	2,65€
13035	333	1,65€
13036	333	1,40€
13037	333	2,10€
13038	330	1,40€
13039	330	1,65€
13040	330	1,80€
13041	330	1,55€
13042	330	1,95€
13043	330	1,20€
13044	330	1,55€
13045	330	1,20€
13046	330	1,55€
13047	330	1,45€
13048	330	2,20€
13049	330	2,05€
13050	331	1,55€
13051	331	1,50€
13052	331	1,25€
13053	331	2,80€
13054	331	2,35€
13055	331	3,00€
13056	331	1,55€
13057	331	1,50€
13058	331	2,20€
13059	331	2,35€
13060	331	1,60€
13061	331	2,65€
13062	331	2,35€
13063	331	1,15€

REF.	pag.	PDR
13064	331	2,60€
13065	331	2,00€
13066	331	2,25€
13067	331	2,55€
13068	330	2,85€
13069	330	4,55€
13070	330	2,15€
13071	330	2,05€
13072	330	2,75€
13073	330	2,10€
13074	331	4,65€
13075	331	5,35€
13076	331	3,90€
13077	331	2,55€
13078	331	2,55€
13079	331	3,35€
13080	330	1,75€
13081	330	2,30€
13082	330	1,35€
13083	330	1,50€
13084	330	2,10€
13085	330	1,60€
13086	330	1,25€
13087	330	3,30€
13088	330	2,40€
13089	330	1,70€
13090	330	1,70€
13091	330	1,25€
13092	332	1,65€
13093	332	2,95€
13094	332	1,50€
13095	332	1,20€
13096	332	1,70€
13097	332	1,20€
13098	332	1,65€
13099	332	2,75€
13100	332	1,20€
13101	332	1,50€
13102	332	1,60€
13103	332	1,80€
13104	328	1,90€
13105	328	2,50€
13106	328	2,00€
13107	328	2,15€
13108	328	1,90€
13109	328	2,90€
13110	328	1,85€
13111	328	1,20€
13112	328	1,65€
13113	328	2,20€
13114	328	2,20€
13115	328	2,50€
13116	332	5,45€
13117	332	3,65€
13118	332	15,85€
13119	332	5,60€



REF.	pag.	PDR
13120	332	5,50€
13121	332	8,75€
13122	332	1,95€
13123	332	5,35€
13124	332	8,20€
13125	332	5,95€
13126	332	1,55€
13127	332	5,60€
13128	329	1,85€
13129	329	2,00€
13130	329	3,75€
13131	329	3,45€
13132	329	2,65€
13133	329	3,45€
13134	329	3,95€
13135	329	3,45€
13136	329	2,60€
13137	329	2,25€
13138	329	2,85€
13139	329	3,85€
13140	329	2,65€
13141	329	1,80€
13142	329	3,10€
13143	329	1,95€
13144	329	2,20€
13145	329	3,85€
13146	329	4,50€
13147	329	3,10€
13148	329	3,30€
13149	329	3,10€
13150	329	2,25€
13151	329	5,35€
13152	329	3,05€
13153	329	3,10€
13154	329	3,20€
13155	329	5,60€
13156	329	3,30€
13157	329	3,85€
13158	329	3,75€
13159	329	3,20€
13160	329	5,00€
13161	329	3,55€
13162	329	2,60€
13163	329	2,80€
13217	347	3,50€
13226	51	4,50€
13227	51	4,50€
13228	51	4,50€
13229	51	4,50€
13230	51	4,50€
13231	51	4,50€
13232	51	4,50€
13234	249	224,50€
13235	319	0,15€
13236	319	0,15€
13237	319	0,15€

REF.	pag.	PDR
13238	319	0,20€
13239	319	0,20€
13240	319	0,40€
13241	319	0,55€
13243	342	12,50€
13244	342	12,50€
13245	342	12,50€
13447	38	16,50€
13448	38	17,50€
13449	38	20,00€
13450	38	23,00€
13451	38	28,00€
13452	38	29,50€
13453	36	9,00€
13454	36	9,50€
13455	36	10,50€
13456	36	11,50€
13457	36	12,00€
13460	36	15,00€
13462	36	17,00€
13463	37	5,30€
13464	37	5,30€
13465	37	5,55€
13466	37	5,55€
13467	37	6,00€
13468	37	6,25€
13469	37	6,25€
13470	37	6,60€
13471	37	6,90€
13472	37	7,25€
13473	37	8,10€
13474	37	8,70€
13475	37	9,10€
13476	37	9,60€
13477	37	9,85€
13478	37	12,20€
13479	37	13,10€
13480	37	15,45€
13481	37	15,75€
13482	37	22,10€
13483	37	25,45€
13484	37	27,15€
13485	36	7,60€
13486	36	8,35€
13487	36	9,40€
13488	36	11,05€
13489	36	12,65€
13490	36	13,60€
13491	36	5,30€
13492	36	5,35€
13493	36	5,50€
13494	36	6,00€
13495	36	6,40€
13496	36	6,60€
13497	36	7,50€
13498	36	8,50€

REF.	pag.	PDR
13499	139	11,00€
13500	139	11,00€
13667	51/77	18,00€
13668	47/77	19,00€
13669	49/77	18,00€
13672	261	220,00€
13674	52/319	0,50€
13675	52/319	0,50€
13676	52/319	0,50€
13677	52/319	0,50€
13678	52/319	0,50€
13679	197	10,50€
13680	152	15,50€
13681	152	15,50€
13682	152	15,50€
13683	152	15,50€
13684	152	15,50€
13685	152	15,50€
13686	152	15,50€
13687	152	15,50€
13688	152	15,50€
13689	152	15,25€
13704	204	21,00€
13707	63	14,00€
13708	63	14,00€
13709	63	14,00€
13710	63	14,00€
13712	63	14,00€
13717	347	11,50€
13723	155	15,00€
13724	155	15,00€
13725	155	15,00€
13726	155	15,50€
13727	155	14,50€
13728	155	14,50€
13729	155	17,50€
13730	155	17,50€
13731	155	17,50€
13732	155	18,50€
13733	155	19,50€
13734	155	20,00€
13735	155	20,50€
13736	155	20,00€
13738	304	3,00€
13739	304	5,00€
13740	304	5,00€
13741	303	21,00€
13745	155	19,50€
13746	155	19,50€
13747	155	19,50€
13748	155	19,00€
13805	300	10,50€
13806	300	10,50€
13809	148	18,50€
13810	148	20,50€
13813	163	6,00€

REF.	pag.	PDR
13814	163	10,00€
13815	118/291	8,50€
13817	137	17,00€
13818	137	20,50€
13819	321	6,50€
13820	321	7,00€
13821	321	14,00€
13822	321	11,00€
13823	321	6,00€
13824	321	8,00€
13825	321	11,50€
13826	321	13,00€
13827	321	15,00€
13828	321	11,50€
13829	321	10,50€
13830	321	10,50€
13831	321	12,55€
13832	321	13,00€
13833	321	9,00€
13836	254	9,00€
13839	118/278	8,50€
13842	160	8,50€
13843	160	7,00€
13844	160	9,00€
13845	160	8,00€
13853	254	122,00€
13856	182	7,80€
13859	154	16,00€
13870	259	82,00€
13874	154	17,50€
13875	154	18,50€
13876	154	18,50€
13877	154	18,50€
13879	303	1,20€
13880	304	1,20€
13884	77	12,50€
13892	258	195,50€
13923	77	9,00€
13929	338	3,60€
13930	148	1,50€
13931	148	2,50€
13932	148	2,50€
13933	148	2,00€
13934	148	2,50€
13935	148	2,50€
13936	148	3,50€
13937	148	4,00€
13938	148	3,50€
13939	148	4,00€
13945	322	4,70€
13946	322	6,05€
13947	322	5,50€
13948	322	4,70€
13949	322	6,50€
13950	322	7,30€
13951	322	5,15€

REF.	pag.	PDR
13952	322	9,50€
13953	322	7,00€
13954	322	11,00€
13955	322	4,70€
13956	322	4,10€
13957	322	6,40€
13958	322	5,15€
13959	322	8,65€
13960	322	9,00€
13961	322	8,60€
13962	322	1,80€
13963	322	11,50€
13964	322	13,00€
13965	322	1,50€
13966	322	12,90€
13967	322	4,65€
13968	342	3,00€
13969	183	15,50€
13982	243/246	4,00€
14004	153	9,50€
14005	153	10,50€
14006	153	9,50€
14007	153	9,50€
14008	153	9,50€
14009	153	9,50€
14010	153	11,00€
14011	153	11,00€
14013	137	3,50€
14014	247	6,00€
14015	247	6,00€
14016	247	6,00€
14026	56	5,50€
14027	56	5,60€
14028	56	7,00€
14029	56	8,50€
14030	56	9,50€
14031	118	10,00€
14032	118	12,00€
14033	118	4,50€
14034	346	9,00€
14049	65	8,00€
14050	65	10,50€
14051	65	18,00€
14052	65	19,50€
14059	73	62,00€
14060	73	65,00€
14061	73	93,00€
14062	73	100,00€
14063	73	118,50€
14064	73	39,50€
14068	254	13,00€
14069	254	13,00€
14070	254	115,50€
14071	254	21,50€
14072	254	21,50€
14073	254	128,00€

REF.	pag.	PDR
14075	148	2,00€
14076	148	1,50€
14077	148	4,50€
14078	148	4,00€
14081	270	12,55€
14083	347	19,50€
14090	261	103,00€
14103	165	28,00€
14104	165	28,00€
14105	165	28,00€
14106	165	28,00€
14107	165	28,00€
14108	165	28,00€
14109	270	29,00€
14110	270	110,00€
14114	77	21,85€
14118	294	26,00€
14120	130	22,00€
14121	130	26,00€
14122	131	34,00€
14123	131	33,00€
14124	133	20,50€
14125	134	19,50€
14126	135	46,50€
14127	135	32,50€
14128	134	13,50€
14129	133	12,50€
14130	133	21,00€
14131	136	24,00€
14132	133	21,50€
14133	134	16,50€
14134	134	17,50€
14135	133	12,50€
14136	137	12,00€
14137	138	130,50€
14141	73	104,50€
14142	73/177	101,50€
14143	73	124,00€
14144	73	304,00€
14145	266	8,50€
14146	266	8,00€
14147	266	25,00€
14148	266	25,00€
14153	132	20,50€
14154	138	37,00€
14157	138/210	7,50€
14158	138/210	5,00€
14159	138/210	11,00€
14160	138/210	6,50€
14161	138/210	12,00€
14162	139	22,00€
14163	139	21,50€
14164	139	22,00€
14165	130	26,50€
14167	64	2,50€
14168	145	7,00€

REF.	pag.	PDR
14169	147	3,00€
14172	151	8,50€
14173	151	9,50€
14177	151	9,50€
14178	151	9,50€
14179	62	8,50€
14180	62	7,90€
14182	258	21,00€
14183	46	31,00€
14187	208	4,50€
14188	141	0,50€
14189	347	28,50€
14190	148	2,00€
14191	148	2,00€
14192	148	4,00€
14193	148	4,00€
14195	147	4,00€
14196	147	4,00€
14197	147	4,50€
14198	147	4,00€
14199	147	4,00€
14200	147	4,50€
14201	147	4,00€
14202	147	4,00€
14203	147	4,50€
14204	147	1,50€
14205	147	1,50€
14206	147	1,50€
14207	147	1,50€
14208	147	1,50€
14209	147	1,50€
14211	192	11,00€
14212	192	12,00€
14213	192	12,00€
14214	192	14,00€
14286	139	3,00€
14287	139	3,00€
14288	138	5,50€
14289	138	5,00€
14291	263	86,50€
14296	76	99,00€
14297	76	72,50€
14298	76	44,50€
14299	76	72,50€
14300	207	16,00€
14301	207	16,00€
14314	147	5,00€
14315	147	4,50€
14327	81	177,00€
14329	258	0,50€
14330	139	3,50€
14336	132	58,00€
14340	191	10,50€
14341	191	10,50€
14342	191	10,50€
14343	191	10,50€

REF.	pag.	PDR
14344	191	11,00€
14345	191	11,00€
14346	191	11,00€
14347	341	36,50€
14348	212	12,50€
14349	212	20,50€
14350	335/336	1,80€
14351	336	1,65€
14352	336	1,30€
14353	336	2,10€
14354	78	14,00€
14355	336	1,70€
14356	336	1,90€
14357	336	1,90€
14358	335/336	1,70€
14359	333/336	1,05€
14361	336	1,70€
14364	336	1,90€
14365	336	1,90€
14366	336	1,45€
14367	336	1,30€
14368	336	1,45€
14369	336	4,95€
14370	336	3,00€
14371	336	3,00€
14372	336	1,20€
14373	336	1,35€
14374	336	1,70€
14375	336	1,85€
14376	336	2,60€
14377	336	1,90€
14378	336	1,90€
14379	336	1,45€
14380	345	51,00€
14381	336	1,70€
14382	336	1,85€
14383	336	1,35€
14384	336	2,10€
14387	335	1,45€
14388	335	2,05€
14389	335	1,25€
14390	335	1,35€
14391	335	2,15€
14392	335	1,35€
14393	335	1,50€
14395	335	1,65€
14396	335	1,20€
14397	335	1,45€
14398	335	1,30€
14399	335	1,90€
14402	335	1,50€
14404	335	2,10€
14405	335	1,45€
14406	335	1,55€
14408	335	1,45€
14409	335	1,35€

REF.	pag.	PDR	REF.	pag.	PDR	REF.	pag.	PDR	REF.	pag.	PDR
14410	335	1,85€	14472	333	1,35€	14630	96	22,00€	14691	95	166,50€
14411	335	1,70€	14473	245	46,00€	14631	96	3,50€	14692	95	5,50€
14412	335	1,70€	14474	335	1,50€	14632	96	3,50€	14693	91	3,50€
14413	335	3,25€	14475	335	1,65€	14633	132	22,50€	14694	91	11,50€
14414	335	1,70€	14476	335	2,05€	14634	96	36,50€	14695	91	4,00€
14415	335	1,70€	14477	335	2,45€	14635	96	10,00€	14696	91	18,00€
14416	335/336	1,25€	14478	335	4,05€	14636	103	30,00€	14697	91	8,00€
14419	335	1,95€	14479	335	1,65€	14637	89	15,50€	14698	91	1,00€
14420	335	1,50€	14480	335	2,05€	14638	89	7,00€	14699	91	30,00€
14421	335	2,45€	14481	335	1,70€	14639	260	195,00€	14700	91	2,50€
14422	334	1,50€	14507	374	52,50€	14640	89	8,00€	14701	91	2,50€
14423	334	3,55€	14534	144	16,50€	14641	89	18,50€	14702	91	91,50€
14424	334	1,85€	14560	144	7,50€	14642	89	83,00€	14703	245	13,00€
14425	334	2,05€	14561	144	7,50€	14643	90	24,50€	14706	263	8,90€
14426	334	1,90€	14563	209	18,00€	14644	90	8,00€	14708	254	59,00€
14427	334	1,20€	14564	161	9,20€	14645	90	44,50€	14709	254	121,50€
14428	334	1,40€	14565	161	26,70€	14646	90	109,50€	14710	161	3,50€
14429	334	1,80€	14566	161	16,70€	14647	94	3,00€	14711	161	3,75€
14430	334	2,25€	14567	161	37,95€	14648	86/87/88	105,15€	14712	161	4,00€
14431	334	1,45€	14568	161	9,20€	14649	94	50,00€	14713	161	4,25€
14432	334	1,45€	14569	161	9,20€	14650	94	5,00€	14714	161	4,50€
14434	334	1,60€	14570	161	4,05€	14651	94	86,00€	14715	161	4,75€
14435	334	1,45€	14571	161	9,20€	14652	92	45,00€	14723	154	18,00€
14436	334	1,70€	14572	161	38,00€	14653	92	5,00€	14724	154	18,50€
14437	334	1,45€	14573	161	4,05€	14654	92	99,50€	14725	154	18,50€
14438	334	1,35€	14578	78	12,50€	14655	92	6,50€	14726	154	17,50€
14439	334	1,75€	14580	78	40,50€	14656	92	5,00€	14727	263	108,00€
14440	334	1,75€	14583	132	6,00€	14657	92	5,00€	14728	150/155	3,00€
14441	334	1,65€	14589	261	2,50€	14658	92	45,00€	14729	150/155	3,50€
14442	334	1,45€	14594	207/323	2,00€	14659	92	5,00€	14730	150/155	3,50€
14443	334	1,45€	14595	207/323	1,50€	14660	92	83,00€	14731	150/155	3,00€
14444	334	1,90€	14596	207/323	2,00€	14661	92	9,00€	14732	150/155	3,50€
14445	334	1,45€	14597	207/323	7,60€	14662	92	2,50€	14733	150/155	4,00€
14446	334	2,80€	14598	207/323	17,80€	14663	92	2,50€	14734	150/155	4,50€
14447	333/334	1,45€	14599	207/323	4,50€	14664	93	95,50€	14735	150	6,50€
14448	334	2,05€	14600	207/323	9,50€	14665	93	9,00€	14736	151/155	5,00€
14449	333/334	2,20€	14601	207/323	11,00€	14666	93	78,00€	14737	151/155	5,00€
14450	334	2,15€	14602	207/323	11,00€	14667	93	9,00€	14738	155	5,00€
14451	334	2,15€	14606	244	57,00€	14668	93	8,00€	14739	155	5,00€
14452	334	2,55€	14607	244	164,50€	14670	93	5,00€	14740	155	5,00€
14453	334	3,05€	14608	244	69,00€	14671	94	44,00€	14741	155	5,00€
14455	334	2,10€	14609	244	16,00€	14672	94	5,00€	14742	155	5,00€
14456	334	1,35€	14610	244	36,50€	14674	94	72,50€	14743	155	5,00€
14457	334	1,70€	14611	197	12,00€	14675	86/87/88	17,00€	14744	155	5,00€
14458	333	1,70€	14612	197	11,00€	14676	86/87/88	36,50€	14745	155	5,50€
14459	333	1,45€	14613	197	13,50€	14677	86/87/88	9,00€	14746	155	6,00€
14460	333	1,15€	14615	255	9,50€	14678	86/87/88	86,00€	14747	155	6,50€
14461	333	1,35€	14616	260	95,90€	14679	86/87/88	9,50€	14748	155	7,00€
14462	333	1,65€	14618	131	19,00€	14680	93	17,00€	14749	29/154	2,00€
14463	333	1,65€	14622	110/346	17,00€	14681	93	107,50€	14750	29/154	2,00€
14464	333	1,50€	14623	110/346	8,00€	14682	93	9,00€	14751	29/154	4,00€
14465	333	2,00€	14624	110/346	17,00€	14683	93	86,00€	14752	29/154	4,00€
14466	333	1,65€	14625	110/346	14,00€	14684	90	3,00€	14753	126	13,00€
14468	333	1,30€	14626	110/346	7,00€	14685	90	5,00€	14755	266	133,15€
14469	333	1,45€	14628	96	2,50€	14686	90	72,50€	14756	266	15,15€
14471	333	1,90€	14629	96	4,00€	14687	90	35,00€	14757	266	15,15€



REF.	pag.	PDR
14758	266	18,00€
14759	266	18,00€
14765	89	96,50€
14766	92	3,50€
14767	92	3,00€
14768	93	28,00€
14769	86/87/88	37,75€
14770	93	40,00€
14771	146/277	10,50€
14772	146	8,50€
14774	277	10,50€
14775	313	30,50€
14779	133	33,00€
14781	310	9,90€
14783	78	5,50€
14785	264	3,50€
14786	308	48,00€
14793	310	18,60€
14802	313	44,00€
14803	314	42,50€
14807	347	11,00€
14808	92	4,00€
14825	106	1,50€
14826	106	1,50€
14827	106	2,00€
14828	106	1,50€
14829	106	1,50€
14830	106	1,50€
14831	106	1,50€
14832	106	2,00€
14833	106	2,05€
14834	106	2,50€
14835	106	3,00€
14836	106	3,50€
14837	106	3,00€
14838	106	3,00€
14839	106	4,00€
14840	106	4,00€
14841	106	1,50€
14842	106	7,50€
14843	107	0,50€
14844	107	0,50€
14845	107	0,50€
14846	107	0,50€
14847	107	0,50€
14848	107	0,50€
14849	107	1,00€
14850	107	1,00€
14851	107	1,00€
14852	107	1,00€
14853	107	1,00€
14854	107	1,00€
14855	107	1,00€
14856	107	1,00€
14857	107	1,50€
14858	107	1,50€

REF.	pag.	PDR
14859	107	1,50€
14860	107	2,00€
14861	107	2,00€
14862	107	2,00€
14863	107	2,50€
14864	107	2,50€
14865	107	2,50€
14866	107	3,00€
14867	107	3,00€
14868	107	0,55€
14869	107	0,60€
14870	107	1,00€
14871	107	1,00€
14872	107	1,00€
14873	107	1,00€
14874	107	1,00€
14875	107	1,50€
14876	107	1,50€
14877	107	1,50€
14878	107	2,00€
14879	107	2,00€
14880	107	2,50€
14881	107	2,50€
14882	107	3,00€
14883	107	3,50€
14884	107	3,65€
14885	107	4,00€
14886	107	4,60€
14887	107	5,00€
14888	107	6,00€
14889	107	6,50€
14890	107	7,00€
14891	107	7,50€
14892	107	8,00€
14893	109	2,00€
14894	109	2,60€
14895	109	2,90€
14896	109	3,60€
14897	109	2,00€
14898	109	2,25€
14899	109	2,60€
14900	109	2,85€
14901	108	3,60€
14902	108	4,60€
14903	108	5,25€
14904	108	6,85€
14905	108	8,50€
14906	108	10,15€
14907	106	0,50€
14908	106	0,60€
14909	106	0,80€
14910	106	1,00€
14911	106	1,30€
14912	106	1,55€
14913	106	1,90€
14914	106	2,10€

REF.	pag.	PDR
14915	106	2,65€
14916	106	2,95€
14917	106	3,45€
14918	292/310	0,20€
14919	292/310	0,50€
14920	106	2,50€
14922	347	1,65€
14923	347	1,65€
14924	347	1,65€
14925	347	1,65€
14926	347	1,90€
14929	258	21,50€
14930	184	9,50€
14931	184	8,00€
14932	184	9,50€
14933	184	9,50€
14934	108	4,25€
14935	108	8,40€
14936	90	27,50€
14937	247	9,50€
14938	264	41,50€
14939	264	57,00€
14940	264	248,00€
14945	345	303,50€
14946	345	58,00€
14947	345	201,50€
14948	345	251,50€
14950	96	6,50€
14951	96	6,50€
14952	96	6,50€
14953	96	6,50€
14954	90	14,50€
14955	94	7,50€
14956	92	8,00€
14957	92	7,50€
14958	92	22,00€
14959	92	10,00€
14960	93	7,50€
14961	93	7,50€
14962	94	6,50€
14963	94	7,50€
14964	90	8,00€
14965	90	8,50€
14966	95	7,50€
14967	91	5,50€
14968	91	6,00€
14969	91	9,00€
14970	150	2,50€
14971	150	2,50€
14972	150	3,50€
14973	150	11,50€
14974	347	3,50€
14975	347	64,00€
14976	347	27,50€
14978	56	7,50€
14979	56	9,00€

REF.	pag.	PDR
14980	56	13,00€
14981	56	22,50€
14982	56	27,50€
14985	109	6,00€
14986	109	4,00€
14987	109	8,50€
14988	109	8,00€
14989	109	6,00€
14990	109	10,50€
14991	109	2,00€
14992	180	8,50€
14993	109	5,00€
14994	109	3,50€
14995	109	8,00€
14996	348	64,50€
15001	336	3,00€
15006	42	3,50€
15010	216	16,50€
15011	216	18,00€
15012	216	31,50€
15014	92/109	20,00€
15018	75/247	46,00€
15019	78	6,00€
15020	42	4,00€
15021	78	12,50€
15022	78	15,00€
15023	78	12,50€
15024	78	15,00€
15025	78	12,50€
15026	78	15,00€
15029	78	8,00€
15030	78	8,00€
15031	78	8,00€
15032	78	16,00€
15033	78	6,00€
15034	78	56,50€
15035	78	8,50€
15036	78	8,50€
15037	78	8,00€
15038	78	34,50€
15039	78	7,50€
15040	78	12,50€
15041	78	15,00€
15042	78	7,50€
15043	260	194,50€
15044	260	259,00€
15046	260	46,50€
15047	260	46,50€
15048	260	5,00€
15049	103	44,50€
15050	78	9,50€
15051	347	3,00€
15052	208	1,50€
15053	208	8,50€
15054	208	28,50€
15056	347	17,00€

REF.	pag.	PDR
15058	78	7,50€
15059	310	10,00€
15062	310	1,00€
15065	78	6,50€
15068	78	18,00€
15069	78	28,50€
15070	74	0,50€
15071	74	0,60€
15072	74	0,70€
15073	74	1,00€
15074	74	1,00€
15075	74	1,20€
15076	74	3,50€
15084	75/183	46,50€
15085	364	156,00€
15093	257	82,50€
15094	257	167,00€
15095	257	19,00€
15096	257	87,00€
15098	101	11,50€
15099	101	5,50€
15100	101	70,00€
15101	101	11,00€
15102	101	40,00€
15103	101	20,50€
15104	101	31,50€
15105	101	30,00€
15106	101	15,00€
15107	102	7,50€
15108	102	5,50€
15109	102	28,00€
15110	102	10,00€
15111	102	32,50€
15112	102	7,00€
15113	102	15,00€
15114	101	6,00€
15115	101	8,50€
15116	101	29,50€
15117	101	29,50€
15118	101	52,00€
15119	101	10,00€
15120	101	6,50€
15121	101	12,00€
15122	37/76	69,00€
15123	245	32,00€
15124	103	9,50€
15125	103	23,00€
15126	98	19,50€
15127	98	29,00€
15138	53	9,50€
15139	53	10,50€
15140	53	12,00€
15144	80	30,00€
15145	80	20,45€
15146	80	16,15€
15147	55	4,50€

REF.	pag.	PDR
15148	55	4,50€
15149	55	4,50€
15151	96	10,50€
15152	341	142,50€
15153	284	2,50€
15154	284	7,50€
15155	42/76	56,00€
15156	40/76	58,00€
15157	41/76	42,00€
15158	38/76	50,00€
15159	41/76	39,00€
15160	39/77	39,00€
15161	39/77	56,00€
15162	34/77	25,50€
15182	42	4,50€
15183	42	5,00€
15184	42	5,50€
15185	42	6,00€
15186	42	6,50€
15187	42	6,50€
15188	42	7,00€
15189	42	8,50€
15190	42	9,00€
15191	41	7,00€
15192	41	8,00€
15193	41	8,50€
15194	41	10,50€
15195	41	12,50€
15196	39	5,00€
15197	39	5,50€
15198	39	6,50€
15199	39	7,50€
15200	39	9,50€
15201	39	9,50€
15206	40	15,00€
15207	40	16,50€
15208	40	17,00€
15209	40	18,00€
15210	41	5,00€
15211	41	5,50€
15212	41	6,50€
15213	41	7,00€
15214	41	9,00€
15215	41	10,50€
15216	38	6,75€
15217	38	7,20€
15218	38	7,65€
15219	38	8,10€
15220	38	9,05€
15221	38	10,85€
15222	38	11,75€
15223	39	14,00€
15224	39	15,00€
15225	39	15,50€
15226	39	17,50€
15227	34	3,50€

REF.	pag.	PDR
15228	34	4,00€
15229	34	5,00€
15230	34	5,00€
15231	34	3,50€
15232	34	4,00€
15233	34	5,00€
15234	34	3,00€
15237	271	12,00€
15238	271	5,00€
15239	271	5,50€
15240	271	9,50€
15241	271	65,00€
15242	271	2,50€
15243	271	4,00€
15244	271	2,00€
15245	271	7,50€
15246	271	108,00€
15247	271	2,50€
15248	271	2,50€
15249	271	5,00€
15250	271	4,50€
15251	271	15,00€
15253	196/201	57,00€
15254	89	12,50€
15255	259	113,50€
15256	340	36,00€
15257	340	27,50€
15258	340	27,50€
15259	340	18,00€
15260	340	22,50€
15276	97	45,50€
15277	97	9,00€
15278	97	3,50€
15279	97	68,50€
15280	97	91,00€
15282	247	15,00€
15283	247	27,50€
15300	291	5,00€
15305	247	19,50€
15306	247	27,50€
15307	247	39,55€
15308	247	7,00€
15309	247	17,00€
15310	247	11,50€
15311	247	11,50€
15312	247	11,50€
15313	78	14,00€
15314	207	3,15€
15316	38/77	50,00€
15317	291	4,50€
15318	247	17,00€
15320	97	1,00€
15321	97	3,00€
15322	97	3,50€
15323	97	24,00€
15324	97	18,00€

REF.	pag.	PDR
15325	97	3,50€
15326	97	1,00€
15327	97	5,50€
15328	37	6,00€
15329	37	5,50€
15330	37	5,50€
15331	37	5,50€
15332	37	6,00€
15333	37	6,50€
15334	37	7,00€
15335	37	7,50€
15336	37	8,00€
15337	37	8,50€
15338	37	9,00€
15339	37	9,50€
15340	341	5,50€
15341	341	5,50€
15342	341	9,00€
15343	341	9,50€
15344	341	6,50€
15345	341	10,50€
15346	341	24,00€
15349	341	8,50€
15352	37	6,00€
15353	37	6,00€
15354	37	6,00€
15355	37	6,00€
15356	37	6,00€
15357	37	6,50€
15358	37	6,50€
15359	37	7,00€
15360	37	7,50€
15361	37	8,00€
15362	37	8,50€
15363	37	9,00€
15364	37	9,00€
15365	37	10,00€
15366	37	10,50€
15367	37	11,50€
15368	37	12,50€
15369	37	13,00€
15370	37	13,50€
15371	37	20,00€
15372	37	23,00€
15373	37	29,00€
15380	98	168,50€
15381	98	5,50€
15382	98	42,00€
15385	119	18,00€
15388	276	33,00€
15389	276	18,50€
15390	276	42,50€
15391	276	13,50€
15392	276	17,50€
15393	276	12,50€
15394	276	26,00€

REF.	pag.	PDR
15395	276	3,50€
15398	276	74,50€
15399	276	116,50€
15424	104/275	105,00€
15425	104/275	50,00€
15426	104/275	10,00€
15427	104/275	9,00€
15428	104/275	238,00€
15429	104/275	23,50€
15430	104/275	83,00€
15431	104/275	241,00€
15432	104/275	18,50€
15433	104/275	169,00€
15434	104/275	147,00€
15435	104/275	24,50€
15436	104/275	97,00€
15437	104/275	305,50€
15438	104/275	31,00€
15439	104/275	52,00€
15440	98	33,00€
15448	280	5,50€
15454	60/77	33,00€
15460	281	3,00€
15471	102	8,50€
15472	102	5,50€
15473	102	3,00€
15474	102	0,50€
15475	102	1,50€
15476	102	1,50€
15477	102	1,00€
15478	102	0,50€
15481	100	4,50€
15482	100	4,00€
15483	100	4,00€
15484	100	5,50€
15485	100	4,00€
15486	100	9,00€
15487	100	58,50€
15488	100	4,00€
15489	100	10,50€
15490	100	4,00€
15491	100	4,00€
15492	100	5,00€
15493	100	4,50€
15494	180	12,50€
15495	180	12,50€
15496	180	11,50€
15497	180	11,00€
15498	180	11,50€
15499	180	11,00€
15500	180	10,00€
15501	180	10,00€
15502	180	10,00€
15503	180	11,00€
15504	180	10,00€
15505	180	4,00€

REF.	pag.	PDR
15506	180	4,00€
15507	180	4,50€
15508	180	4,50€
15509	180	5,00€
15510	180	5,00€
15511	180	8,00€
15514	77	11,50€
15515	38	15,50€
15516	38	19,00€
15517	38	22,50€
15526	258	47,50€
15527	258	276,00€
15528	258	39,00€
15530	91	7,50€
15531	91	5,00€
15532	91	98,00€
15533	91	4,50€
15534	91	4,50€
15535	91	3,50€
15536	91	14,50€
15537	91	6,00€
15538	91	17,00€
15539	251	103,50€
15542	251	45,00€
15550	247	6,00€
15551	247	6,00€
15552	174/285	181,00€
15553	244	107,50€
42446	307	14,80€
50400	172	158,00€
50403	172	99,00€
50409	172	26,00€
50410	172	158,00€
50431	127	4,80€
50517	285	99,00€
50518	285	128,00€
50523	127	4,50€
50524	127	4,50€
50525	291	1,00€
50526	291	4,50€
50551	127	330,00€
50560	39	35,00€
50561	40	18,00€
50562	40	20,00€
50564	39	30,00€
50566	16	32,00€
50567	61	9,60€
50577	165	12,00€
50580	61	11,00€
50585	296	14,70€
50600	298	0,70€
50601	298	0,35€
50622	38	48,50€
50623	25	53,50€
50630	263	599,00€
50631	261	68,00€

REF.	pag.	PDR
50632	273	327,00€
50644	162/293	11,60€
50651	324	16,50€
50652	324	16,50€
50654	290/307	4,00€
50656	174/285	250,00€
50717	162/293	21,00€
50724	204	24,50€
50731	251	68,00€
50751	248	38,00€
50754	38	59,00€
50760	298	0,09€
50761	298	0,18€
50762	298	0,26€
50763	298	0,35€
50764	298	0,44€
50765	298	0,51€
50766	298	0,61€
50767	298	0,70€
50768	298	0,79€
50771	298	0,29€
50774	298	0,57€
50776	298	0,76€
50777	298	0,73€
50778	298	0,09€
50779	298	0,18€
50780	298	0,26€
50781	298	0,35€
50782	298	0,44€
50783	298	0,53€
50784	298	0,61€
50785	298	0,70€
50786	298	0,77€
50787	216	8,00€
50788	216	14,50€
50789	216	29,00€
50790	216	29,00€
50792	188	93,50€
50793	188	84,50€
50797	250/284	490,00€
50807	207/324	35,00€
50808	83	84,00€
50815	255	88,00€
50816	254	88,00€
50818	255	279,00€
50819	256	28,00€
50820	256	34,50€
50821	256	47,00€
50822	256	61,00€
50823	256	98,00€
50824	256	93,50€
50825	256	154,00€
50827	211/261	387,00€
50830	258	560,00€
50831	261	460,00€
50835	259	290,00€

REF.	pag.	PDR
50836	262	148,00€
50838	262	299,00€
50839	264	224,00€
50840	262	144,00€
50843	83	88,00€
50844	83	76,00€
50852	248	24,50€
50889	40	64,50€
50896	39	47,50€
50901	162	16,00€
50902	45	13,00€
50903	163	23,80€
50910	126	45,00€
50911	263	1.245,00€
50913	174/286	169,00€
50915	127	5,40€
50916	172	0,88€
50917	246	228,00€
50918	246	299,00€
50923	169/264	390,00€
50924	243/246	299,00€
50935	246	495,00€
50937	204	10,00€
50942	268/282	24,00€
50957	288	22,00€
50958	287	38,00€
50959	288/320	12,00€
50960	287	21,50€
50966	290/307	4,00€
50980	32	22,00€
50982	32	22,00€
50983	28	48,00€
50985	28	59,00€
51017	60	6,50€
51018	60	6,50€
51020	60	6,50€
51021	60	6,50€
51028	154	158,00€
51033	277	98,00€
51035	80	799,00€
51050	287	195,00€
51051	287	28,00€
51055	298	0,85€
51056	298	0,75€
51059	177	94,50€
51119	187	56,40€
51120	210	39,80€
51121	210	26,00€
51122	197	154,50€
51123	196	88,50€
51124	197	99,00€
51125	196	81,50€
51126	198	12,00€
51127	203	55,50€
51131	161	56,00€
51138	201	188,00€



REF.	pag.	PDR
51140	201	59,00€
51206	130	209,00€
51207	130	264,00€
51210	131	560,00€
51211	131	498,00€
51212	131	448,00€
51213	131	599,00€
51214	133	138,00€
51215	134	99,00€
51216	135	548,00€
51218	135	248,00€
51219	134	221,50€
51220	133	210,00€
51221	133	178,00€
51222	136	121,50€
51225	133	198,00€
51226	134	233,00€
51227	134	193,00€
51231	201	188,00€
51235	267	49,00€
51238	266	129,00€
51239	266	156,00€
51245	133	99,00€
51246	293	6,40€
51253	246	39,00€
51258	117	0,15€
51259	193	53,50€
51260	26	34,00€
51261	26	34,00€
51262	203	51,00€
51266	162/293	27,60€
51270	53	12,00€
51272	57	7,50€
51277	144	64,00€
51283	176	66,50€
51285	53	9,00€
51287	53	14,00€
51305	54	21,50€
51306	54	20,50€
51307	54	29,70€
51315	346	2,50€
51318	36	89,00€
51326	117	4,40€
51332	180	98,00€
51333	29	18,00€
51336	151	21,05€
51337	184	48,00€
51338	203	52,50€
51339	208	199,00€
51340	239	38,00€
51341	142/216	35,00€
51347	214	9,00€
51349	200	35,00€
51352	181	8,50€
51353	181	10,50€
51354	182	11,00€

REF.	pag.	PDR
51355	64/298	18,00€
51356	252	68,00€
51358	302	7,50€
51359	302	9,00€
51360	163	6,00€
51361	163	9,80€
51362	302	3,00€
51363	266	103,00€
51364	201	26,00€
51365	266	106,00€
51368	194	18,00€
51369	194	22,50€
51378	77	21,00€
51382	53	10,00€
51383	144	10,50€
51384	26	34,00€
51385	142	3,80€
51386	142	5,40€
51387	142	2,50€
51388	135	18,00€
51389	135	18,00€
51390	135	18,00€
51391	135	18,00€
51392	135	25,00€
51393	135	25,00€
51400	184	17,00€
51401	184	22,00€
51402	184	20,50€
51403	184	17,50€
51405	54	21,10€
51406	54	29,20€
51409	26	36,00€
51410	26	36,00€
51412	294	2,00€
51414	194	11,00€
51416	301	12,00€
51419	79	4,00€
51422	79	6,00€
51439	135	25,00€
51440	135	25,00€
51441	135	25,00€
51442	135	25,00€
51443	142	5,00€
51444	142	5,00€
51445	142	5,00€
51446	177/292	2,50€
51447	56	16,00€
51448	56	51,35€
51452	262	69,00€
51456	79	725,00€
51479	57	29,00€
51488	239	16,00€
51489	239	12,00€
51490	196	32,00€
51491	186	141,50€
51493	186	66,00€

REF.	pag.	PDR
51494	184	107,00€
51495	191	53,50€
51496	192	8,00€
51499	184	146,00€
51500	194	28,00€
51501	195	43,50€
51504	48	8,50€
51525	57	9,80€
51526	57	9,80€
51528	42	43,00€
51529	40	53,00€
51538	322	0,15€
51539	322	0,15€
51540	322	0,15€
51541	322	0,25€
51542	322	0,20€
51543	322	0,25€
51544	322	0,25€
51545	322	0,30€
51546	322	0,19€
51554	322	0,28€
51570	84	182,50€
51573	117/292	2,50€
51574	82	58,00€
51575	82	350,50€
51576	79	178,00€
51600	82	109,00€
51604	298	0,75€
51612	127	6,80€
51613	127	3,80€
51614	127	4,50€
51615	127	6,80€
51616	24	359,00€
51617	25	67,50€
51622	173	199,00€
51633	173/306	2,00€
51634	173/306	2,00€
51653	79	9,80€
51654	80	5,00€
51655	81	6,00€
51656	82	6,00€
51657	83	9,00€
51658	84	5,50€
51659	38	59,00€
51661	55/301	11,50€
51674	48	7,00€
51680	288	2,40€
51681	288	4,50€
51691	288	2,40€
51692	288	3,50€
51693	288	3,50€
51694	288	3,50€
51696	288	3,50€
51697	291	0,50€
51703	304	8,50€
51705	304	7,00€

REF.	pag.	PDR
51706	304	19,50€
51707	304	9,00€
51708	304	13,00€
51709	304	14,00€
51710	304	16,50€
51711	304	19,50€
51712	304	9,60€
51713	304	12,00€
51714	304	15,80€
51715	304	19,00€
51716	304	22,30€
51717	304	11,20€
51718	304	13,60€
51719	304	20,50€
51720	304	22,00€
51721	304	23,50€
51722	304	13,05€
51723	304	17,00€
51724	304	22,50€
51725	304	25,60€
51726	304	33,00€
51727	304	44,00€
51737	80	699,00€
51738	80	850,00€
51741	301	0,50€
51742	301	0,50€
51743	301	0,55€
51745	306	0,70€
51746	32	12,00€
51747	41	21,00€
51750	263	299,00€
51751	264	125,50€
51785	306	0,75€
51795	65	9,00€
51796	65	14,00€
51797	65	18,00€
51798	65	35,00€
51799	322	0,20€
51801	55	62,00€
51804	320	57,50€
51805	56	17,00€
51812	61	44,00€
51814	291	7,99€
51816	267	49,00€
51817	290/307	4,50€
51818	18	95,00€
51819	15	48,00€
51824	172	38,00€
51830	204	76,50€
51831	270	21,00€
51832	163	18,00€
51837	274	195,00€
51838	274	734,00€
51839	178/269	24,00€
51842	267	6,90€
51843	322	0,19€

REF.	pag.	PDR
51853	49	18,00€
51855	24	359,00€
51858	295	15,00€
51859	270	3,80€
51861	134/303	199,00€
51863	295	54,00€
51864	42	64,00€
51878	41	48,00€
51879	41	38,50€
51886	126	44,00€
51889	113	45,00€
51890	30/43	78,00€
51893	189	557,00€
51895	255	99,00€
51896	187	75,00€
51897	187	112,50€
51898	187	125,00€
51899	187	123,00€
51901	259	999,00€
51902	195	99,00€
51905	256	34,50€
51906	256	40,00€
51907	256	50,00€
51908	299	44,00€
51909	47	2,50€
51918	48	12,50€
51919	205	72,00€
51920	206	18,00€
51921	53	16,00€
51923	181	11,00€
51925	291	1,00€
51927	240	25,00€
51928	250	13,00€
51929	126	21,00€
51930	25	39,00€
51934	181	10,00€
51935	293	198,00€
51936	293	198,00€
51937	293	198,00€
51943	226	199,50€
51951	49	15,60€
51952	45	13,30€
51953	45	13,30€
51955	44	5,00€
51958	205	340,00€
51960	122	29,80€
51961	122	29,80€
51962	121	23,00€
51963	121	27,00€
51964	121	26,50€
51965	121	27,50€
51966	122	18,00€
51967	123	15,80€
51968	123	15,80€
51969	123	14,00€
51972	59	12,00€

REF.	pag.	PDR
51973	295	44,50€
51975	79	2,00€
51976	79	4,00€
51978	171	79,00€
51980	143	15,00€
51981	143	21,50€
51982	285	99,00€
51983	285	149,00€
51984	285	178,00€
51985	172	109,00€
51986	206	9,80€
51989	213	46,00€
51991	195	48,00€
51995	62/63	24,50€
51996	202	8,00€
51998	190	31,50€
51999	202	87,50€
52009	34	36,00€
52010	198	53,00€
52012	205	66,50€
52013	50	14,00€
52014	50	14,00€
52016	188	2,10€
52017	188	2,40€
52018	188	2,60€
52019	188	3,20€
52021	188	3,40€
52022	188	4,50€
52023	188	6,60€
52024	188	10,60€
52025	188	13,00€
52026	163	25,55€
52027	316	14,00€
52028	318	11,50€
52029	318	14,00€
52030	321	84,50€
52031	320	40,00€
52032	321	28,00€
52033	325	37,50€
52043	319	16,50€
52044	317	19,00€
52047	127	4,50€
52048	127	5,00€
52049	50	14,00€
52050	63	98,00€
52052	61	46,50€
52053	327	38,50€
52054	327	15,50€
52055	262	129,00€
52056	205	61,00€
52057	172	6,80€
52058	172	4,50€
52059	32	29,00€
52060	32	32,00€
52065	172	44,50€
52066	215	12,00€

REF.	pag.	PDR
52068	44	4,50€
52069	266	26,50€
52070	266	36,00€
52071	266	42,50€
52072	44	5,00€
52076	190	111,00€
52077	163	29,50€
52148	83	89,00€
52149	285	198,00€
52152	59	13,50€
52153	190	42,00€
52156	140	126,50€
52157	141	48,00€
52158	320	38,50€
52159	141	54,50€
52160	141	42,00€
52162	269	32,50€
52163	322	86,00€
52165	140	105,00€
52167	140	43,50€
52169	46	25,00€
52170	46	15,50€
52171	141	39,00€
52172	74	780,00€
52180	48	19,00€
52181	48	22,50€
52182	48	24,00€
52183	48	26,20€
52184	48	43,00€
52185	48	64,00€
52186	48	72,00€
52187	295	26,00€
52188	49	15,50€
52190	194	8,00€
52191	180	198,00€
52195	273	170,00€
52197	54	36,00€
52198	31	33,00€
52200	287	88,00€
52201	286	66,00€
52202	286	80,00€
52207	53	16,50€
52227	212	198,00€
52230	174/286	295,00€
52231	296	45,50€
52233	267	288,00€
52235	66	11,00€
52236	66	12,50€
52237	66	17,00€
52238	66	23,50€
52241	259	1.690,00€
52242	252	12,00€
52243	252	7,50€
52244	171	79,00€
52251	295	26,00€
52254	119	64,00€

REF.	pag.	PDR
52259	291	3,50€
52262	167	7,50€
52263	167	13,50€
52264	167	23,00€
52265	167	30,50€
52269	182	7,00€
52270	199	99,50€
52271	239	18,00€
52272	61	28,00€
52273	186	44,00€
52275	178	38,00€
52293	193	89,00€
52295	167	6,50€
52296	198	106,50€
52297	198	149,00€
52298	198	154,50€
52302	124	19,60€
52303	124	19,60€
52304	256	84,00€
52305	190	93,50€
52308	84	630,00€
52309	84	995,00€
52310	306	4,00€
52311	181	19,00€
52312	181	9,00€
52313	181	8,00€
52314	181	24,00€
52315	178	14,00€
52316	192	18,00€
52317	192	19,00€
52318	212	64,50€
52319	212	8,20€
52320	32	22,00€
52321	168	8,80€
52327	168	12,00€
52328	187	80,00€
52329	243	34,50€
52330	176	100,50€
52331	140	201,50€
52337	150	51,00€
52338	151	32,50€
52339	153	58,00€
52340	153	58,00€
52341	150	47,50€
52342	151	53,00€
52343	152	43,00€
52344	153	158,00€
52345	150	87,50€
52346	150	87,00€
52347	154	130,50€
52348	154	154,00€
52349	66	18,50€
52350	66	21,00€
52351	66	23,00€
52352	66	27,00€
52353	66	28,00€

REF.	pag.	PDR	REF.	pag.	PDR	REF.	pag.	PDR	REF.	pag.	PDR
52354	66	32,00€	52455	178	16,00€	52525	56	12,50€	52608	183	42,50€
52355	66	36,00€	52456	121	32,75€	52526	56	27,50€	52609	52	29,00€
52357	66	47,00€	52458	126	53,35€	52527	141	78,00€	52613	212	21,00€
52358	66	54,50€	52460	49	15,00€	52528	137	42,50€	52615	181	100,00€
52362	128	1,68€	52461	49	24,00€	52530	296	16,00€	52616	240	42,00€
52363	128	1,68€	52462	51	24,00€	52533	167	10,00€	52617	183	7,00€
52364	128	3,92€	52463	51	24,50€	52534	296	16,00€	52618	292	52,00€
52365	128	3,42€	52464	51	39,00€	52535	296	16,50€	52619	63	23,10€
52366	128	0,57€	52466	216	11,00€	52536	113	57,00€	52620	215	8,00€
52367	128	0,57€	52467	216	10,00€	52538	29	62,00€	52621	212	11,00€
52368	128	1,56€	52468	57	5,90€	52539	29	59,00€	52622	185	73,50€
52369	128	1,62€	52472	57	4,90€	52540	135	220,50€	52624	194	25,50€
52370	128	1,59€	52473	57	8,00€	52541	196	43,50€	52625	64/178	9,00€
52371	128	0,50€	52474	166	57,50€	52542	83	109,00€	52626	196	39,50€
52373	79	268,00€	52475	166	54,50€	52543	143	157,00€	52627	196	82,50€
52375	122	35,25€	52476	166	49,80€	52544	154	78,00€	52628	250	26,50€
52378	142/216	9,50€	52477	166	61,00€	52545	154	138,00€	52629	185	90,50€
52381	145	20,50€	52478	166	49,00€	52546	153	31,50€	52633	304	1,00€
52382	268/282	18,00€	52479	166	40,80€	52547	150	76,00€	52634	79	6,00€
52384	113	19,00€	52480	166	43,80€	52550	28	89,00€	52635	79	5,50€
52385	165	219,50€	52481	166	46,00€	52551	200	150,50€	52636	176	111,00€
52386	165	22,00€	52482	166	43,80€	52552	303	128,00€	52637	202	44,50€
52387	165	22,80€	52483	166	40,80€	52555	117	1,80€	52638	64	9,00€
52388	165	24,50€	52484	166	56,50€	52558	117	1,80€	52639	195	117,50€
52389	64/178	29,00€	52485	166	46,50€	52565	48	11,50€	52640	195	46,50€
52390	165	31,00€	52486	166	51,50€	52566	124	23,95€	52641	195	49,00€
52391	252	5,00€	52487	166	55,00€	52567	124	23,95€	52642	196	30,50€
52392	252	5,00€	52488	188	24,50€	52568	124	23,95€	52643	272	478,35€
52393	74	1.180,00€	52489	189	56,50€	52569	124	23,95€	52644	304	7,50€
52412	61	5,00€	52490	144	6,50€	52570	306	4,00€	52645	304	0,55€
52414	124	15,90€	52491	144	10,50€	52571	306	4,00€	52646	304	0,50€
52415	124	15,90€	52493	291/311	4,50€	52572	306	4,00€	52648	143	9,00€
52416	182	10,50€	52494	200	226,50€	52573	306	4,00€	52649	301	5,00€
52417	182	24,00€	52495	206	14,50€	52574	137	64,00€	52650	301	5,00€
52418	24	144,00€	52497	215	18,00€	52575	52/137	99,50€	52652	300	2,80€
52419	79	108,00€	52498	250	61,50€	52583	204	7,50€	52653	300	3,00€
52420	79	135,00€	52500	44	16,50€	52585	54	31,50€	52654	301	6,50€
52421	79	196,50€	52502	164	28,00€	52586	54	37,50€	52655	302	37,00€
52422	160	24,00€	52503	164	29,50€	52587	54	28,50€	52656	302	29,50€
52424	65	56,00€	52504	164	25,00€	52588	54	38,50€	52657	302	37,90€
52425	48	28,50€	52505	164	18,00€	52589	167	12,50€	52658	302	37,90€
52426	48	46,50€	52506	164	16,00€	52591	214	12,00€	52659	302	37,90€
52427	48	61,00€	52507	164	27,00€	52592	214	19,00€	52660	303	128,00€
52428	246	39,00€	52508	63	33,00€	52593	214	31,30€	52661	303	290,00€
52430	308	12,50€	52509	63	33,60€	52595	51	58,00€	52662	300	36,50€
52432	199	35,00€	52510	164	28,50€	52596	51	112,00€	52663	300	33,00€
52433	204	4,80€	52511	164	40,50€	52597	51	128,50€	52664	302	168,00€
52434	178	125,50€	52512	164	44,50€	52598	104/275	1.080,00€	52665	298	0,35€
52436	268	1.170,00€	52514	264	94,00€	52599	189	215,00€	52666	298	0,35€
52439	268	214,00€	52515	64/213	9,10€	52600	281	884,00€	52667	298	0,64€
52445	308	3,85€	52516	216	25,50€	52601	246	352,50€	52668	298	1,21€
52450	269	117,50€	52517	216	5,50€	52603	27	74,00€	52669	298	1,80€
52451	41	38,50€	52518	181	88,00€	52604	27	78,00€	52670	298	2,50€
52452	243	8,00€	52519	34	25,50€	52605	27	78,00€	52671	298	2,97€
52453	243	19,00€	52521	33	125,00€	52606	27	88,00€	52672	298	3,56€
52454	201	11,00€	52524	56	51,50€	52607	183	49,00€	52673	300	18,00€



REF.	pag.	PDR
52675	139	79,00€
52676	139	93,00€
52677	182	17,00€
52678	182	18,00€
52681	307	15,80€
52682	307	15,80€
52683	307	15,80€
52685	188	76,00€
52687	208	158,50€
52690	193	39,00€
52691	192	53,50€
52692	262	129,00€
52693	210	24,50€
52694	150	38,00€
52696	213	8,00€
52697	213	12,50€
52699	196	18,00€
52700	192	20,50€
52703	319	19,00€
52711	319	27,50€
52713	18	89,00€
52714	31	15,50€
52715	31	10,00€
52716	31	15,50€
52717	31	11,00€
52718	141	48,00€
52719	322	0,19€
52721	17	55,00€
52722	17	98,00€
52723	17	56,00€
52724	1337	330,00€
52725	137	298,00€
52727	198	30,00€
52728	198	84,50€
52729	198	144,50€
52730	198	299,50€
52731	198	43,50€
52732	198	74,50€
52733	198	147,50€
52734	210	43,50€
52735	148	4,50€
52736	148	4,50€
52737	148	5,00€
52738	306	5,00€
52739	306	5,00€
52740	120	624,00€
52742	295	64,00€
52748	45	43,50€
52749	169	79,00€
52753	28	98,00€
52754	188	48,50€
52757	213	16,00€
52758	139	78,00€
52760	64/213	4,10€
52761	59	8,00€
52762	59	9,00€

REF.	pag.	PDR
52765	167	21,50€
52767	136	328,00€
52768	290	18,55€
52769	290	20,50€
52770	290	19,55€
52771	290	20,15€
52772	290	18,55€
52773	290	20,50€
52774	290	19,55€
52775	290	20,15€
52776	290	18,55€
52777	290	20,50€
52778	290	19,55€
52779	290	20,15€
52780	290	18,55€
52781	290	20,50€
52782	290	19,55€
52783	290	20,15€
52786	58	14,00€
52787	145	9,00€
52788	162	39,00€
52789	249	15,20€
52791	62/63	18,00€
52793	204	37,00€
52794	204	24,00€
52795	290	6,00€
52796	207	85,20€
52797	249	227,50€
52798	144	18,00€
52801	186/249	24,00€
52802	191	49,50€
52804	242	337,50€
52805	242	422,50€
52806	242	739,00€
52807	242	1.540,00€
52809	181	7,80€
52810	153	9,20€
52811	153	9,20€
52812	63	64,50€
52813	186	71,00€
52814	132	528,00€
52815	190	96,50€
52816	190	25,50€
52817	190	23,50€
52818	300	168,00€
52819	240	22,00€
52820	187	43,50€
52821	184	27,50€
52822	187	32,00€
52823	191	99,00€
52824	138	573,50€
52827	122	45,50€
52828	122	42,50€
52829	303	19,00€
52830	49	24,00€
52831	49	18,00€

REF.	pag.	PDR
52832	191	65,00€
52833	192	39,30€
52834	199	186,50€
52835	199	272,00€
52836	120	1.100,00€
52838	126	56,00€
52839	126	57,00€
52842	301	11,00€
52843	122	27,00€
52845	264	199,00€
52846	61	37,80€
52847	61	37,80€
52848	126	75,60€
52849	202	7,50€
52850	185	6,50€
52851	163/335	8,10€
52852	64	6,80€
52857	244	7,50€
52858	185	298,00€
52861	128	0,50€
52862	128	1,80€
52863	128	1,80€
52864	128	1,80€
52865	128	0,50€
52866	128	0,50€
52867	128	1,00€
52869	84	51,50€
52870	84	99,00€
52871	84	247,50€
52873	204	9,50€
52874	195	68,50€
52875	195	72,50€
52876	160	182,00€
52877	58	13,80€
52878	58	11,20€
52879	58	11,20€
52880	55/301	38,50€
52881	55/301	17,00€
52882	160	14,00€
52883	114	38,00€
52884	267	69,50€
52885	64	18,00€
52886	328	18,00€
52887	328	22,00€
52888	335	24,00€
52889	333	19,00€
52890	331	22,00€
52891	331	28,00€
52892	330	22,00€
52893	331	26,00€
52894	330	22,00€
52895	332	22,00€
52896	328	24,00€
52897	332	38,00€
52898	332	36,00€
52899	329	34,00€

REF.	pag.	PDR
52900	329	34,00€
52901	329	34,00€
52902	281	904,00€
52903	281	920,00€
52904	204	55,50€
52905	58	28,00€
52906	177	49,00€
52908	31	17,50€
52909	31	12,50€
52910	122	39,00€
52912	42	78,50€
52913	203	292,00€
52914	156	199,00€
52915	156	179,00€
52916	156	169,00€
52917	156	118,00€
52918	156	135,00€
52919	156	165,00€
52920	156	132,50€
52921	156	99,00€
52922	156	134,00€
52923	156	47,50€
52924	157	58,00€
52925	157	142,50€
52926	157	159,50€
52927	157	65,00€
52928	157	139,00€
52929	157	145,00€
52930	157	115,00€
52931	157	45,00€
52932	157	44,00€
52933	157	165,50€
52934	158	88,00€
52935	158	85,00€
52936	158	158,00€
52937	158	215,00€
52938	158	157,50€
52939	158	28,00€
52940	158	200,00€
52941	158	61,00€
52942	158	84,50€
52943	158	69,00€
52944	158	89,00€
52945	158	220,50€
52946	122	41,50€
52948	52	27,00€
52949	52	29,00€
52950	52	17,00€
52951	52	17,50€
52952	268/282	64,80€
52953	142	38,00€
52955	59	21,00€
52956	59	22,00€
52957	59	25,50€
52958	59	30,95€
52959	59	38,65€

REF.	pag.	PDR
52960	59	47,05€
52961	193	82,50€
52962	190	44,00€
52963	251	48,00€
52964	60	9,00€
52965	60	9,00€
52966	60	9,00€
52967	60	9,00€
52969	151	17,00€
52970	39	37,00€
52971	39	52,50€
52972	30/43	79,00€
52973	40	57,00€
52974	40	16,00€
52975	40	66,50€
52976	40	22,00€
52977	162	120,00€
52980	273	745,00€
52982	60/165	49,00€
52985	261	598,00€
52987	114	19,00€
52991	252	10,50€
52992	252	18,00€
52998	167	55,15€
52999	260	168,00€
53001	206	222,00€
53007	128	0,50€
53008	181	15,50€
53009	185	38,00€
53010	44	16,50€
53017	36	52,00€
53018	38	136,00€
53019	36	78,00€
53020	37	199,00€
53021	36	44,00€
53022	36	46,00€
53025	47	3,50€
53026	47	5,50€
53027	47	7,50€
53028	269	4,00€
53029	269	5,50€
53030	269	10,00€
53031	84	68,00€
53032	84	129,00€
53033	295	15,50€
53037	304	0,50€
53038	304	0,50€
53039	304	0,50€
53040	304	0,50€
53041	187	33,50€
53042	204	9,90€
53043	152	38,50€
53044	153	116,00€
53045	125	35,00€
53046	125	34,00€
53047	125	265,35€

REF.	pag.	PDR
53048	125	78,60€
53049	125	78,60€
53051	124	136,40€
53052	124	136,40€
53053	194	10,00€
53054	213	4,00€
53055	212	30,50€
53056	200	126,50€
53057	206	134,00€
53058	200	177,00€
53059	200	47,00€
53060	151	31,00€
53061	25	41,00€
53062	197	99,00€
53063	144	29,00€
53064	144	29,00€
53065	144	30,00€
53066	144	49,50€
53067	144	48,00€
53068	144	52,00€
53069	184	98,00€
53070	66	16,00€
53071	66	19,00€
53072	66	29,00€
53073	66	46,00€
53074	14	78,00€
53075	15	49,90€
53076	30	72,00€
53077	152	61,00€
53078	243	18,00€
53079	169	89,00€
53080	169	99,00€
53081	203	115,00€
53082	203	148,00€
53083	50	54,50€
53084	32	24,00€
53085	117	29,00€
53086	213	9,00€
53087	289	13,50€
53088	289	13,50€
53089	289	13,50€
53090	289	13,50€
53091	289	14,00€
53092	289	14,00€
53093	289	14,00€
53094	289	14,00€
53095	50	18,00€
53096	213	26,50€
53098	53	11,00€
53099	53	13,00€
53100	53	17,00€
53101	16	35,00€
53102	16	39,00€
53103	26	36,00€
53104	26	36,00€
53105	26	36,50€

REF.	pag.	PDR
53106	18	99,90€
53108	17	99,00€
53110	163/335	22,00€
53111	271	17,00€
53112	254	299,00€
53116	73	99,00€
53118	211	204,50€
53119	160	45,00€
53120	50	6,00€
53121	50	8,00€
53122	50	9,50€
53124	169	286,50€
53125	168	477,00€
53126	170	243,00€
53127	32	12,00€
53129	202	70,50€
53134	170	116,50€
53136	139	163,00€
53137	136	38,00€
53140	137	95,00€
53141	137	65,50€
53144	251	18,00€
53145	272	38,50€
53146	198	30,50€
53147	142	41,00€
53150	278/291	22,50€
53151	129	12,50€
53152	33	373,00€
53154	33	462,00€
53156	31	22,50€
53158	23	148,00€
53159	21	279,00€
53161	258	298,00€
53162	272	56,00€
53164	34	15,00€
53165	34	17,50€
53166	277	10,50€
53167	277	12,50€
53168	277	19,00€
53177	289	14,20€
53178	289	14,20€
53179	289	14,20€
53180	289	14,20€
53181	289	21,70€
53182	289	21,70€
53183	289	21,70€
53184	289	21,70€
53185	289	14,60€
53186	289	22,10€
53187	252	39,00€
53188	252	7,00€
53189	278	99,00€
53190	278	98,00€
53191	173	14,80€
53192	173	49,00€
53196	215	21,00€

REF.	pag.	PDR
53197	152	40,50€
53198	252	9,50€
53199	115/342	24,00€
53200	257	69,00€
53201	16	34,00€
53202	145	15,65€
53203	128	0,50€
53204	145	78,00€
53205	145	19,00€
53206	182	33,50€
53207	191	99,00€
53208	119	113,00€
53209	267	7,50€
53210	66	45,00€
53211	83	79,00€
53212	20	188,00€
53214	242	281,50€
53215	251	18,00€
53216	112	49,00€
53217	112	29,00€
53218	257	24,00€
53219	15	49,00€
53220	273	368,00€
53221	292	4,75€
53222	82	72,50€
53224	160	141,50€
53225	47	3,50€
53226	173	13,50€
53227	117	28,00€
53229	321	35,00€
53230	163	19,00€
53232	163	39,00€
53235	184	9,50€
53236	184	11,55€
53237	184	12,50€
53238	184	16,50€
53240	214	58,00€
53241	296	9,00€
53246	263	1.144,00€
53249	214	175,00€
53250	185	71,00€
53251	213	88,00€
53253	110	98,00€
53256	299	34,00€
53258	110	75,40€
53259	218	97,00€
53260	218	230,50€
53261	218	201,50€
53262	219	233,00€
53263	219	56,50€
53264	219	141,50€
53265	219	185,50€
53266	220	210,00€
53267	220	255,50€
53268	220	92,00€
53269	220	49,50€

REF.	pag.	PDR
53270	221	63,50€
53271	221	213,50€
53272	221	172,50€
53273	221	68,00€
53274	224	30,50€
53275	226	35,50€
53276	223	156,00€
53277	223	45,00€
53278	222	141,50€
53279	224	90,00€
53280	222	102,50€
53281	223	53,50€
53282	223	48,00€
53283	224	92,00€
53284	224	285,00€
53285	224	56,00€
53286	224	87,00€
53287	224	228,50€
53288	226	72,00€
53289	227	45,00€
53290	227	51,00€
53291	227	68,00€
53292	228	116,00€
53293	228	133,50€
53294	229	119,00€
53295	229	77,00€
53296	230	60,00€
53297	230	44,50€
53298	230	84,50€
53299	231	267,00€
53300	231	40,50€
53301	231	44,00€
53302	232	44,00€
53303	232	89,00€
53304	232	257,50€
53305	232	135,50€
53306	233	54,50€
53307	233	38,50€
53308	234	52,50€
53309	234	262,50€
53310	235	455,00€
53311	235	97,00€
53312	235	127,00€
53313	234	139,00€
53314	234	97,50€
53315	238	262,50€
53316	233	31,50€
53317	240	32,00€
53318	239	24,00€
53319	233	15,00€
53320	239	12,00€
53321	240	10,50€
53323	239	9,50€
53324	229	12,50€
53325	240	7,50€
53326	224	13,50€

REF.	pag.	PDR
53327	224	11,00€
53328	191	66,00€
53330	186	32,50€
53331	52	29,50€
53332	52	32,00€
53339	49	9,50€
53340	321	74,00€
53343	136	285,00€
53344	136	295,00€
53346	54	18,00€
53347	209	99,00€
53348	316	14,00€
53349	316	14,00€
53350	318	14,00€
53351	317	12,50€
53352	317	12,00€
53353	323	18,00€
53354	318	12,50€
53355	326	11,50€
53356	326	11,50€
53357	266/326	7,00€
53358	326	11,50€
53359	325	14,50€
53360	319	16,00€
53361	319	20,00€
53362	318	12,00€
53363	317	28,00€
53364	317	14,00€
53365	319	14,00€
53366	318	12,50€
53367	326	9,50€
53368	326	9,00€
53369	318	13,00€
53370	316	26,00€
53371	317	26,00€
53372	316	26,00€
53373	323	14,50€
53374	324	10,00€
53376	324	10,50€
53377	322	20,00€
53378	326	13,00€
53380	327	11,50€
53381	323	14,50€
53382	323	11,00€
53383	323	11,50€
53384	198	145,00€
53385	58/335	18,00€
53388	198	90,00€
53389	60	31,50€
53390	62	34,50€
53391	199	74,50€
53392	206	47,50€
53393	199	118,00€
53394	211	584,50€
53395	215	16,00€
53396	62	18,00€

REF.	pag.	PDR
53399	47	3,50€
53400	47	4,50€
53401	47	5,00€
53402	47	9,00€
53403	47	6,00€
53404	47	6,50€
53405	47	5,00€
53406	47	8,00€
53407	47	11,50€
53408	47	17,50€
53409	47	9,00€
53410	206	79,50€
53411	58	5,00€
53412	58	4,00€
53414	162	61,00€
53415	162	181,00€
53416	143	13,50€
53417	143	24,00€
53418	143	15,50€
53419	301	9,00€
53420	42	68,00€
53421	254	320,00€
53422	254	368,00€
53423	263	199,00€
53426	188	28,00€
53427	117	5,00€
53428	123	14,00€
53429	123	14,00€
53430	158	239,50€
53434	325	18,00€
53441	181	9,80€
53443	291	7,00€
53444	23	158,00€
53445	59	17,00€
53449	143	19,50€
53450	143	26,00€
53452	230	26,50€
53453	248	6,00€
53456	207	93,00€
53457	207	23,00€
53459	207	64,00€
53463	201	93,50€
53464	322	139,00€
53465	112	38,00€
53466	112	39,90€
53467	112	47,00€
53468	56	10,50€
53469	73	613,00€
53470	154	146,50€
53472	183	12,00€
53473	183	36,00€
53474	214	78,00€
53477	215	34,50€
53478	56	5,00€
53479	56	6,50€
53480	56	19,50€

REF.	pag.	PDR
53481	56	29,30€
53484	270	615,00€
53485	209	139,50€
53486	160	28,00€
53487	63	16,00€
53488	212	56,50€
53489	188	59,80€
53490	189	252,50€
53492	144/348	379,50€
53499	207	29,00€
53500	207	29,00€
53501	185	20,00€
53502	192	33,50€
53503	269	8,50€
53504	343	48,00€
53505	119	64,00€
53506	119	36,00€
53507	294	24,00€
53508	294	14,00€
53509	73	482,00€
53510	344	24,00€
53511	344	23,00€
53512	344	41,00€
53513	344	9,00€
53514	73	990,00€
53516	123	59,00€
53517	58	9,50€
53518	243	3,50€
53519	113	29,00€
53520	130	228,00€
53522	185	19,20€
53523	227	89,60€
53524	65	46,00€
53525	215	11,00€
53526	277/284	118,00€
53530	114/208	43,50€
53531	150	87,50€
53532	146/284	124,00€
53533	342	1,00€
53536	126	28,05€
53537	183	12,80€
53538	183	12,80€
53539	208	68,00€
53540	289	23,00€
53541	137	144,50€
53542	138	876,50€
53543	278	13,80€
53545	163	33,50€
53547	60	13,50€
53548	60	13,30€
53549	60	13,30€
53550	60	13,30€
53551	307	19,80€
53552	307	19,80€
53553	307	19,80€
53554	17	54,00€



REF.	pag.	PDR
53556	73	990,00€
53557	73	990,00€
53561	294	28,00€
53565	19/82	258,00€
53566	248	32,00€
53567	138/167	40,00€
53568	116	12,00€
53569	116	18,00€
53570	118	154,00€
53572	138/210	275,00€
53573	141	36,00€
53574	29/44	43,50€
53575	46	14,00€
53576	139	189,00€
53577	73	990,00€
53579	73	990,00€
53580	73	990,00€
53581	148/284	107,50€
53582	148/284	178,50€
53583	148/284	169,50€
53584	279/284	108,00€
53585	279/284	168,00€
53586	277/284	158,00€
53587	151	36,00€
53588	130	152,00€
53589	64	12,00€
53590	260	1.190,00€
53591	58	5,50€
53592	250	19,60€
53593	145	41,00€
53594	147	54,00€
53595	147	61,00€
53596	308	3,50€
53597	308	3,50€
53598	308	4,00€
53599	207/323	29,00€
53600	278	13,80€
53601	278	18,00€
53602	59	27,50€
53603	59	44,00€
53604	59	111,00€
53605	302	141,00€
53606	145	49,00€
53607	145	276,50€
53608	132	88,00€
53609	244	180,00€
53610	244	242,50€
53611	144	27,50€
53612	243	88,00€
53613	46	17,00€
53614	46	19,50€
53615	46	30,50€
53616	46	7,50€
53617	46	8,50€
53618	46	10,50€
53620	77	87,50€

REF.	pag.	PDR
53621	288	2,50€
53622	288	2,50€
53623	288	2,50€
53624	288	2,50€
53625	141	68,00€
53626	140/161	17,00€
53627	250	22,50€
53629	147	14,00€
53630	147	17,50€
53631	147	31,50€
53632	147	45,00€
53633	147	42,50€
53634	147	57,00€
53635	201	69,00€
53636	294	18,00€
53637	210	84,50€
53638	201	236,00€
53639	65	22,50€
53640	65	29,50€
53641	65	34,00€
53642	65	42,50€
53643	65	79,00€
53644	245	948,00€
53645	245	199,00€
53646	139	61,50€
53647	19	99,00€
53648	224	106,50€
53649	226	112,60€
53650	212	48,00€
53651	231	82,50€
53652	191	47,00€
53653	229	195,00€
53654	65	74,00€
53655	215	11,50€
53656	272	187,50€
53657	272	231,50€
53658	272	98,50€
53659	272	145,50€
53660	273	136,50€
53661	71	890,00€
53662	209	82,00€
53663	214	6,50€
53664	194	32,50€
53665	212	15,50€
53666	212	22,00€
53667	32	32,00€
53668	32	34,00€
53669	206	45,00€
53670	182	29,50€
53671	53	37,00€
53672	81	440,00€
53673	161	98,00€
53674	80	480,00€
53675	164	43,00€
53676	164	38,00€
53677	164	47,50€

REF.	pag.	PDR
53678	164	44,50€
53681	132	742,50€
53682	262	129,00€
53683	176	106,00€
53684	260	1.880,00€
53685	170	310,00€
53686	71	890,00€
53687	266	298,00€
53688	266	480,00€
53689	131	230,00€
53690	121	32,85€
53691	121	32,85€
53693	303	520,00€
53694	45	17,00€
53695	303	576,00€
53696	202	19,50€
53697	244	369,50€
53698	303	550,00€
53699	245	63,05€
53701	197	173,00€
53702	110	24,50€
53703	110	32,00€
53704	110	36,00€
53705	172	105,50€
53706	222	88,00€
53707	118	152,50€
53708	68-74	292,00€
53710	336	16,00€
53711	336	16,00€
53712	336	16,00€
53713	335	16,00€
53714	335	16,00€
53715	335	19,00€
53716	334	19,00€
53717	334	19,00€
53718	334	19,00€
53719	333	19,00€
53720	333	19,00€
53721	120/290	18,80€
53723	300	68,00€
53724	272	39,00€
53725	254	298,00€
53726	131	118,00€
53727	24	188,00€
53728	24	188,00€
53729	45/215	18,00€
53733	132	227,00€
53734	112	18,00€
53735	183	41,00€
53736	170	97,50€
53737	43	12,50€
53738	43	11,50€
53739	43	10,50€
53740	43	10,00€
53741	183	12,00€
53742	211/261	999,00€

REF.	pag.	PDR
53743	29/154	34,00€
53744	151	51,00€
53745	297	6,00€
53746	297	6,50€
53747	297	6,50€
53748	297	6,50€
53749	297	6,50€
53750	297	6,50€
53751	297	7,00€
53752	297	7,00€
53753	297	7,00€
53754	297	7,50€
53755	297	7,50€
53756	297	8,00€
53757	297	8,50€
53758	297	8,50€
53759	297	8,50€
53760	297	9,50€
53761	71	680,00€
53762	71	680,00€
53763	70	890,00€
53764	70	680,00€
53765	70	890,00€
53766	70	680,00€
53767	71	890,00€
53768	71	680,00€
53769	72/76/228	170,00€
53770	72/76/236	190,50€
53771	72/76/237	154,50€
53772	72/76/237	211,00€
53773	72/76/237	293,00€
53774	72/76/236	189,50€
53775	72/76/238	1.108,50€
53776	114	16,50€
53778	290	4,50€
53779	257	45,00€
53780	115	14,50€
53781	310	28,00€
53782	110	14,00€
53784	133	144,00€
53785	308	4,80€
53786	313	128,00€
53787	309	0,58€
53790	311	19,80€
53791	311	5,80€
53794	308	36,20€
53795	308	1.450,00€
53796	313	99,15€
53797	309	0,10€
53798	308	1,95€
53802	314	290,00€
53803	311	1,80€
53804	311	1,80€
53805	313	220,00€
53806	314	290,00€
53808	312	16,50€

REF.	pag.	PDR
53809	312	8,00€
53811	312	15,90€
53820	274	388,00€
53822	311	4,80€
53824	311	9,00€
53826	310	26,00€
53827	310	67,00€
53828	311	7,30€
53829	311	24,00€
53830	308	2.996,00€
53832	311	1,90€
53835	307	38,00€
53836	307	58,00€
53838	316	48,00€
53839	312	0,25€
53844	309	2,80€
53845	257	88,00€
53849	248	14,50€
53850	106	13,50€
53851	107	74,50€
53852	107	175,50€
53853	107	11,50€
53854	107	23,50€
53855	107	21,50€
53856	107	53,00€
53857	108	23,50€
53858	108	25,00€
53859	108	57,00€
53860	106	3,50€
53861	106	5,00€
53862	310	51,00€
53863	310	15,50€
53864	299	138,00€
53865	340	48,00€
53866	75	615,00€
53867	74	1.095,00€
53868	68	1.090,00€
53869	69	990,00€
53870	69	990,00€
53871	37	59,90€
53872	284	134,00€
53873	247	325,00€
53874	247	398,00€
53875	194/240	125,00€
53876	233	63,50€
53877	345	430,50€
53878	345	574,00€
53879	345	838,50€
53880	264	598,00€
53881	146/284	64,00€
53882	146/284	69,00€
53883	55	16,50€
53884	55	26,00€
53885	55	30,50€
53886	55	18,00€
53887	55	26,00€

REF.	pag.	PDR
53888	55	32,50€
53893	310	21,00€
53895	257	111,50€
53896	257	139,00€
53897	257	168,00€
53898	257	195,00€
53899	307	12,00€
53900	70	890,00€
53901	70	680,00€
53902	310	49,00€
53903	216	59,00€
53904	71	890,00€
53905	62	7,00€
53906	62	8,00€
53907	309	0,16€
53908	62	7,00€
53909	62	9,00€
53910	325	17,50€
53911	62	8,00€
53912	69	1.280,00€
53913	69	1.280,00€
53914	312	75,60€
53915	25/210	57,50€
53916	309	3,80€
53917	44	8,00€
53919	171	85,00€
53920	104/343	537,00€
53921	171	35,00€
53922	171	23,50€
53927	267	58,00€
53928	22	258,00€
53929	267	78,00€
53930	343	276,00€
53931	344	104,00€
53932	59	8,00€
53934	343	602,00€
53939	68	1.280,00€
53940	282/312	13,20€
53941	282/312	5,75€
53942	282/312	0,50€
53943	45/77	18,50€
53944	45/77	18,50€
53945	45/77	18,50€
53946	309	0,78€
53947	276	144,90€
53948	276	323,50€
53949	344	4,50€
53950	344	4,50€
53951	72/240	1.794,00€
53952	72/238	1.794,00€
53953	14	29,00€
53954	43	9,50€
53955	43	10,00€
53956	340	353,00€
53957	309	0,30€
53958	216	4,50€

REF.	pag.	PDR
53959	309	0,78€
53960	309	0,78€
53961	309	0,78€
53963	309	0,78€
53964	295	10,50€
53965	295	29,00€
53967	62	9,50€
53968	255	49,00€
53969	262	96,00€
53970	280	3.790,00€
53971	280	350,00€
53972	203	515,70€
53973	341	284,00€
53974	115	35,50€
53976	62	8,00€
53977	271	14,50€
53978	177	44,00€
53979	43	30,50€
53980	43	30,50€
53981	271	119,00€
53982	271	214,50€
53983	168	214,50€
53984	307	14,80€
53985	307	14,80€
53986	307	14,80€
53987	284/314	8,30€
53988	152	90,00€
53989	307	17,80€
53990	307	17,80€
53991	307	17,80€
53992	325	16,00€
53993	50	66,50€
53994	307	14,90€
53995	307	14,90€
53996	307	14,90€
53997	189	47,50€
53999	97/108	2,00€
54000	97/108	2,50€
54001	258	285,00€
54002	97/108	3,00€
54003	187	88,50€
54004	116	23,00€
54005	30/43	14,00€
54008	97/108	3,50€
54010	97/108	4,50€
54011	97/108	5,00€
54013	291	29,00€
54015	62	9,00€
54016	209	71,00€
54017	50	12,00€
54018	53	9,50€
54019	53	17,00€
54020	341	288,00€
54021	53	12,50€
54022	53	9,50€
54023	53	12,50€

REF.	pag.	PDR
54024	53	17,00€
54028	52	29,00€
54029	52	29,50€
54030	52	18,00€
54031	52	18,00€
54032	37	79,00€
54033	138	49,00€
54034	9	178,00€
54035	10	149,00€
54036	11	99,00€
54037	12	88,00€
54038	13	86,00€
54039	119	154,00€
54040	268	198,00€
54041	37	198,00€
54042	293	13,00€
54043	342	42,50€
54044	125	88,00€
54045	9	179,00€
54046	10	150,00€
54047	11	100,00€
54048	12	89,00€
54049	13	87,00€
54050	251	980,00€
54051	251	50,50€
54052	281	960,00€
54053	281	248,00€
54054	281	336,00€
54055	281	268,00€
54056	281	280,00€
54057	281	298,00€
54058	281	347,00€
54059	281	580,00€
54060	44	4,50€
54061	44	4,50€
54062	280	585,00€
54066	36	78,50€
54068	180	211,50€
54069	201	28,00€
54072	293	38,50€
54076	342	8,00€
54077	207	9,00€
54078	123	64,50€
60001	96	90,00€
60003	96	109,50€
60004	103	79,00€
60005	89	132,00€
60006	90	181,50€
60007	94	170,00€
60008	92	140,50€
60009	92	168,00€
60010	93	169,50€
60011	94	175,00€
60012	105	41,50€
60013	105	79,50€
60015	105	122,00€









# FALTA UMA PEÇA?

Encontre no  
**JBM APP**



**FÁCIL**  
**RÁPIDO**  
**SIMPLES**

Você apenas precisa seguir estas etapas:

1.



ABRA O APLICATIVO

2.



CLIQUE NO QR

3.



CONCENTRE-SE NO ÍCONE  
CAT 2020

4.



A PEÇA SERÁ ABERTA

5.



ENCONTRE A SUA PEÇA



**DESCARREGUE**







## FERRAMENTA A BATERIAS COM MOTOR BRUSHLESS

com uma única bateria adequada para todas as ferramentas

Com motor **BRUSHLESS**:  
maior eficiência, vida útil mais longa,  
mais velocidade e menos ruído.



**BRUSHLESS  
MOTOR**

Ferramentas eléctricas  
sem fio, para uso mais  
confortável e ilimitado



Veja-os na p. 85



**JBM**

[www.jbmcamp.com](http://www.jbmcamp.com)